



**THUNDER SCIENTIFIC CORPORATION**

ELECTRONIC PSYCHROMETER  
MODEL 4A1-MP  
RELATIVE HUMIDITY AND TEMPERATURE  
MEASUREMENT SYSTEM

---

OPERATING AND SERVICE MANUAL

---

---

DATE June 17, 1987



CERTIFICATION OF ACCURACY FOR  
**THUNDER SCIENTIFIC CORPORATION**

PSYCHROMETER MODEL 4A-1MP SERIAL 5090684

ACCURACY IS CERTIFIED TO MEET OR EXCEED  $\pm 1\%$  RH  $\pm .5^\circ$ F  
30°F TO +212° F OVER RH OF 1% TO 100% RH

TRACEABLE TO THE NATIONAL BUREAU OF STANDARDS

DATE JAN 7 86  
DUE JAN 7 87

CERTIFIED BY *Jeff L. Bennewitz*  
JEFF L. BENNEWITZ

© GOES 404

LITHO IN U.S.A.

CERTIFICATION OF ACCURACY FOR  
**THUNDER SCIENTIFIC CORPORATION**

PSYCHROMETER MODEL 4A-1MP SERIAL 5090684

ACCURACY IS CERTIFIED TO MEET OR EXCEED  $\pm 1\%$  RH  $\pm .5^\circ$ F  
30°F TO +212° F OVER RH OF 1% TO 100% RH

TRACEABLE TO THE NATIONAL BUREAU OF STANDARDS

DATE 8/20/86  
DUE 8/20/87

CERTIFIED BY *Jeff L. Bennewitz*  
JEFF L. BENNEWITZ

© GOES 404

LITHO IN U.S.A.

CERTIFICATION OF ACCURACY FOR  
**THUNDER SCIENTIFIC CORPORATION**

PSYCHROMETER MODEL 4A-1MP SERIAL 5090684

ACCURACY IS CERTIFIED TO MEET OR EXCEED  $\pm 1\%$  RH  $\pm .5^{\circ}\text{F}$   
30<sup>o</sup>F To +212<sup>o</sup> F OVER RH OF 1% TO 100% RH

TRACEABLE TO THE NATIONAL BUREAU OF STANDARDS

DATE OCT 21, 88  
DUE OCT 21, 89

CERTIFIED BY *J. L. Bennewitz*  
JEFF L BENNEWITZ

CERTIFICATION OF ACCURACY FOR  
**THUNDER SCIENTIFIC CORPORATION**

PSYCHROMETER MODEL 4A-1MP SERIAL 5090684

ACCURACY IS CERTIFIED TO MEET OR EXCEED  $\pm 1\%$  RH  $\pm .5^{\circ}\text{F}$   
30<sup>o</sup>F To +212<sup>o</sup> F OVER RH OF 1% TO 100% RH

TRACEABLE TO THE NATIONAL BUREAU OF STANDARDS

DATE 16 JUN 87  
DUE 16 JUN 88

CERTIFIED BY *J. L. Bennewitz*  
JEFF L BENNEWITZ

TABLE OF CONTENTS

	PAGE
WARRANTY . . . . .	1
SPECIFICATIONS/FEATURES . . . . .	2
GENERAL DESCRIPTION . . . . .	3
PRE-OPERATIONAL INSPECTION . . . . .	4
SET-UP/TURN-ON PROCEDURES . . . . .	5
PROGRAMMING THE SYSTEM FOR:	
MANUAL OPERATION . . . . .	6
HARDCOPY (PRINTER) OUTPUT . . . . .	8
AUTO MODE OPERATION . . . . .	9
CHANGING THE:	
HARDCOPY TIME INTERVAL . . . . .	10
PRESSURE . . . . .	11
TIME . . . . .	12
DATE . . . . .	12
SWITCHING TO:	
°C . . . . .	13
°F . . . . .	13
SUMMARY OF COMMANDS:	
DISPLAY FUNCTIONS . . . . .	14
ON/OFF FUNCTIONS . . . . .	15
SET FUNCTIONS . . . . .	16
PROBE WICK CHANGEOUT INSTRUCTIONS . . . . .	17
FACTORY CERTIFICATION SERVICE . . . . .	19

DRAWINGS

M83C129	-	FRONT PANEL DETAIL (4A-1MP)
DE83C023	-	PSYCHROMETER PROBE DETAIL DRAWING
S86D016	-	PSYCHROMETER SCHEMATIC DIAGRAM
S83A130	-	DISPLAY BOARD SCHEMATIC DIAGRAM
S83B131	-	PROBE AND CABLE WIRING DIAGRAM

## WARRANTY

Thunder Scientific Corporation warrants each instrument of its manufacture to be free from defect in materials and workmanship.

The limit of liability under this warranty is to repair or replace any part thereof which shall within one year after delivery to the original purchaser, and returned by the original purchaser, prove to be defective after examination by us.

This warranty specifically excludes the probe sensors, which may become damaged or broken due to wick changes. Shipping damage is covered by insurance and will be honored if report is made within one week of receipt of the instrument. Warranty returns must be authorized by the factory.

WARNING -- Calibration seals have been applied to the instrument case, cable, and probe. Should the instrument and/or associated components be opened or tampered with, or if the seals are broken, Thunder Scientific Corporation accepts no responsibility for calibration and this warranty is void.

4A-1MP - MICROPROCESSOR BASED WET BULB, DRY BULB PSYCHROMETER

SPECIFICATIONS

Relative Humidity (RH)

Measurement Range: 1% RH to 100% RH  
Guaranteed Accuracy:  $\pm 1\%$  indicated RH  
Typical Accuracy:  $\pm .5\%$  indicated RH

Temperature

Measurement Range: 0-100°C / 32-212°F  
Guaranteed Accuracy:  $\pm .3^\circ\text{C}$  /  $\pm .5^\circ\text{F}$   
Typical Accuracy:  $\pm .1^\circ\text{C}$  /  $\pm .2^\circ\text{F}$

Readout: °C or °F (user selectable)  
Digital Display: .01%RH and .01° Resolution  
Printer Interface: Trendcom Parallel (std)  
Centronics Parallel (opt)  
RS-232C Serial (opt)  
Printer (optional) Trendcom 200 High Speed  
Intelligent Printer

FEATURES

- \* Z-80 Central Processing Unit, automatically computes percent relative humidity and both temperature and dewpoint in °C and °F.
- \* 3 computer/printer interface options: 2 parallel, 1 serial.
- \* Battery backed-up real time clock.
- \* Timed printer output mode allowing user selectable intervals from 1 minute to 24 hrs in 1 minute increments.
- \* Automatic Mode capability enables probe aspirator for 1 minute prior to each printout.
- \* Full function display capability.
- \* Not susceptible to contamination by chemicals or long term exposure to high temperature and relative humidity.
- \* Certification of Traceability direct to the National Bureau of Standards.

## GENERAL DESCRIPTION

The Thunder Scientific Model 4A-1-MP is a microprocessor based Laboratory Standard Psychrometer designed for precise measurement of air temperature and relative humidity.

The 4A-1-MP uses a 2-bulb measurement system employing wet and dry matched pair calibrated Platinum Resistance Thermometers (PRT's) operating under a controlled air velocity. One PRT, referred to as the dry bulb, is used for sensing air temperature. The other PRT, the wet bulb, uses a specially weaved wick (or sock) to facilitate an unimpeded capillary flow of distilled water from a reservoir below. The wet bulb measures a depression temperature.

The signals from the PRT's are converted to digital format, read by the microprocessor, linearized, and then converted to actual temperature data in both degrees C and degrees F. The data is then used to calculate Percent Relative Humidity and Dew Point Temperature.

Front panel display of any of the above data is selected by user input at the keyboard. The upper display is the data readout device, and the lower display indicates which data or other function is currently enabled. Upon selection of data output to this real-time LED display, current readings are updated 4 to 5 times each second, allowing for fast system response to any changes in the sampled environment.

Printer output, enabled from the keyboard, allows for hardcopy printouts of all current psychrometric data. Printer output is at user selectable timed intervals ranging from a 1 minute minimum to a 24 hour maximum, or at any 1 minute increment in between.

An Auto Mode feature is also included which, when enabled, will put the probe in synchronous operation with the printer. In this mode, the probe aspirator will automatically run prior to any sample for hardcopy output. After printout, the aspirator will be disabled and will remain off until the next sample time is reached.

The Model 4A-1-MP is a precise laboratory instrument and, if handled accordingly, will provide years of excellent service.

## PRE-OPERATIONAL INSPECTION

The 4A-1-MP Psychrometer is shipped from Thunder Scientific Corp (TSC) calibrated and basically ready for operation. Any damage from shipment should be reported to TSC within one week of receipt.

Prior to each use, the following inspection should be performed:

- 1) Inventory. Ensure all necessary parts and components are enclosed.
- 2) Inspect the probe for cleanliness. Pay particular attention to the wick on the wet bulb. If the wick requires changing see the section titled PROBE WICK CHANGE-OUT INSTRUCTIONS.
- 3) Inspect the main psychrometer unit. Ensure the system is clean, that all screws and connecting hardware are tightened, and that all keys operate smoothly without binding or sticking.
- 4) Inspect cables for wear. Cables should be free from any nicks, cuts, or frays, and all connectors should mate easily without binding.



## SYSTEM SET-UP/TURN-ON PROCEDURES

- 1) Remove the black probe housing from its styrofoam holder in the display panel. This housing contains the Platinum Resistance Thermometers (PRT's). A clean wick is installed from the factory on the wet bulb sensor. To the rear of the housing is the aspirator motor which draws air over the PRT's.
- 2) Remove the knurled filler cap on the bottom of the probe housing.
- 3) Fill the reservoir with pure distilled water. (Never use tap water as this will contaminate the wick).
- 4) Replace the filler cap and finger tighten, then gently shake excess water from inside the white probe cylinder. Check for leaks around the bottom edge of the housing. Finger tighten the knurled knob as necessary.
- 5) Place the probe in the environment to be tested and then route and connect one end of the white 12 foot power/signal cable to the connector on the front of the probe housing. Connection to the probe should be smooth, as excessive force could misalign and damage the connectors.
- 6) Connect the other end of the cable to the mating connector on the display panel. Connection here should also be smooth.
- 7) Connect printer (optional) to the multipin connector directly above the probe cable.
- 8) Connect the 6 foot AC power cable to the jack in the display panel and then to a 120 VAC source.
- 9) Turn on the main power switch.
- 10) The upper display should show the time in military format, with a blinking decimal point in the middle (the seconds indicator).
- 11) The lower display should show P--7 (meaning Display Program 7, the time).
- 12) Push the LED TEST button and ensure that all segments and all 4 decimal points of each display light up.

TURN ON IS COMPLETE.

## PROGRAMMING THE SYSTEM FOR MANUAL OPERATION

The 4A-1-MP is a versatile instrument and therefore requires some input from the user. The user must perform at least the following minimum requirements to operate in manual mode:

- \* Ensure the 4A-1-MP displays the correct time.
- \* Ensure the 4A-1-MP displays the correct date.
- \* Input the atmospheric pressure at the probe environment.
- \* Turn on the aspirator motor.
- \* Select the desired display; ie Temp, Dew Point, RH, etc.
- \* Turn off the aspirator when measurements are complete.

Detailed descriptions follow:

- 1) Display the TIME with the following key strokes:

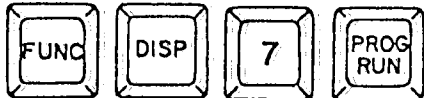

If the time shown on the upper display is incorrect, follow the procedure on CHANGING THE TIME.

- 2) Display the DATE with the following key strokes:



If the date shown on the upper display is incorrect, follow the procedure on CHANGING THE DATE.

- 3) Input the correct barometric pressure in inches of mercury. For example, a pressure of 26.53 in Hg would be input with the following key strokes:

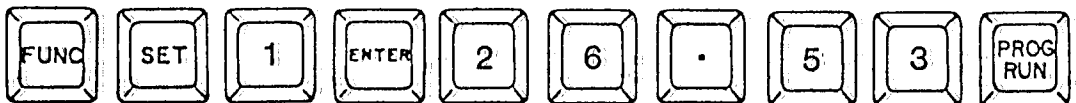

For more detailed information, refer to the section titled CHANGING THE PRESSURE.

- 4) Turn on the aspirator with the following key strokes:



The motor should turn on and the left decimal point of the lower display should light.

5) Select the desired display output with these key strokes:

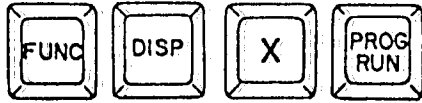

Where X is one of the following:

- 1 - % RH
- 2 - Dew Point Temperature
- 3 - Air Temperature
- 4 - Wet-bulb Temperature
- 5 - Resistance of Dry-bulb in Ohms
- 6 - Resistance of Wet-bulb in Ohms
- 7 - Time
- 8 - Date

6) Once measurement is complete, turn off aspirator with:

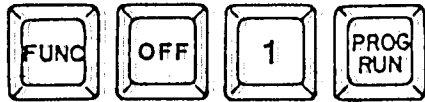

Take additional measurements by repeating steps 4 thru 6.

IMPORTANT NOTE - The fan mounted in the probe housing is designed with a maximum operating life of 300 hours. The motor need not be run for more than 10 minutes before taking Temperature, Dew Point, or Relative Humidity Measurements.

## PROGRAMMING THE SYSTEM FOR HARDCOPY OUTPUT

If a printer is connected to the 4A-1-MP via the multipin connector on the display panel, hardcopy outputs of all pertinent psychrometric data are available. The following sequences are used to control the printer output. Information is sent to the printer once each minute unless the user changes the time interval (see CHANGING THE HARDCOPY TIME INTERVALS).

- \* Turn on the printer function with the following keystrokes:



The second decimal point from the left on the lower display should light.

- \* Turn off the printer function with the following keystrokes:

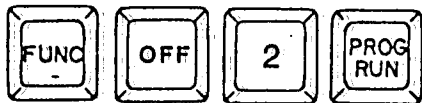

The second decimal point should go out.

When using the printer, the aspirator should also be turned on. To enable and/or disable the aspirator, refer to the previous section on PROGRAMMING THE SYSTEM FOR MANUAL OPERATION.

Any one of the following printer/computer interfaces are available:

- 1) Trendcom compatible parallel
- 2) Centronics compatible parallel
- 3) RS-232C Serial, 300 to 9600 Baud

Consult TSC for your particular requirements.

## PROGRAMMING THE SYSTEM FOR 'AUTO MODE' OPERATION

In 'Auto Mode' operation, the aspirator motor function is automatic and is under computer control. If the hardcopy output is enabled, (as previously described), the computer will turn on the aspirator precisely 60 seconds prior to print time, and will turn the motor off immediately after print. This feature extends the service of the aspirator motor which has a 300 hour maximum run-life. It also provides for accuracy and repeatability of measurements, as the motor is run for equal amounts of time prior to each and every printout.

\* To enable the Auto Mode, type the following keystrokes:

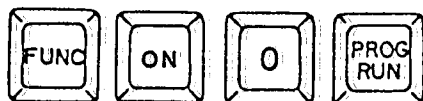

Now anytime the printer is enabled, (see PROGRAMMING THE SYSTEM FOR HARDCOPY OUTPUT), the probe will automatically turn on and off at the correct times.

\* Disable the Auto Mode function with the following key strokes:



The Auto Mode is now disabled and control of the aspirator is solely under user keyboard control. The printer function is not affected.

Note - Default interval is 1 minute between printouts. This means that in the Auto Mode, when the printer function is enabled, the motor will stay on continuously unless the time interval is changed (see CHANGING HARDCOPY TIME INTERVALS).

Note - If the motor happens to be on when either the Auto Mode or the printer function is turned off from the keyboard by the user, the aspirator motor may also need to be turned off in the same manner.

## CHANGING THE HARDCOPY TIME INTERVAL

The 4A-1-MP is capable of sending data to a printer or some other device, such as a computer, at specified time intervals. The information sent consists of Date, Time, Dry Bulb, Wet Bulb, and Dewpoint temperatures, Relative Humidity, and Saturation Vapor Pressure over water at the Dry and Wet Bulb temperatures. A header is sent before the first line of data and every 23 lines thereafter. The time between each printout defaults to the minimum interval of 1 minute each time the system is turned on, but is keyboard selectable up to 24 hours.

\* To change the INTERVAL, follow the sample below. This example changes the interval to 1 hour 25 minutes (but you can use your own interval instead).

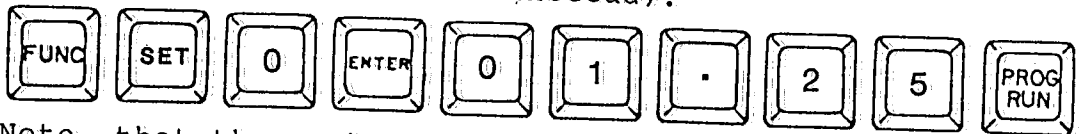

Note that the number on the lower display begins flashing when the SET key is pushed. When the ENTER key is pushed, the number stops flashing, indicating that the computer acknowledges the key and is now awaiting the interval input. The interval numbers will appear on the upper display, shifting the old numbers out to the left as the new numbers are punched in. (This same procedure occurs for all SET commands; ie, Pressure, Time, and Date.)

## CHANGING THE PRESSURE

The 4A-1-MP has been programmed from the factory with a barometric pressure of 29.92 inches of mercury (in HG). The instrument uses the barometric pressure for all calculations of Relative Humidity and Dewpoint temperature. It is recommended that the absolute pressure be measured in the environment where the probe is to be set up and used. The pressure should also be measured frequently during the operation of the system, as the accuracy of the calculations can differ as much as 2%RH for every inch of mercury.

\* To change the PRESSURE, follow the sample below. This example changes the pressure to 25.75 in HG.



You must type in all 4 digits including the decimal point. For an explanation of the upper and lower display readings during this keyboard sequence, refer to CHANGING THE HARDCOPY TIME INTERVAL.

CHANGING THE TIME/DATE

The 4A-1-MP contains a battery backed-up Real Time Clock. The clock operates on a four year calendar, meaning that it makes no adjustment for leap year. Should it require setting for any reason, refer to the below procedures.

- \* To change the TIME, follow the sample below. This example changes the time to 3:40 PM.

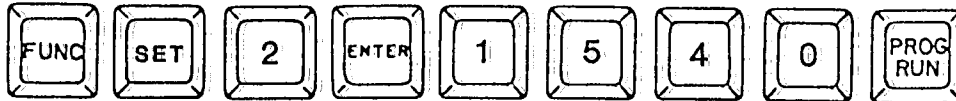

Note that the time is input in MILITARY FORMAT, and that no decimal point is needed between the hours and minutes. For an explanation of the display readings during this keyboard sequence, refer to CHANGING THE HARDCOPY TIME INTERVAL.

- \* To change the DATE, follow the sample below. This would change the date to June 4th.

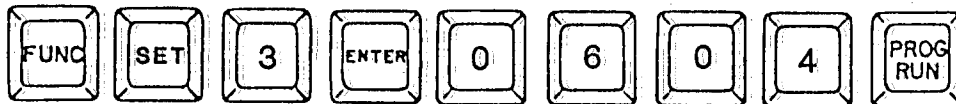

Note that June was input as '06' and that the day was input as '04'. Both digits of each must be typed.



SWITCHING TO °C/°F

The 4A-1-MP is capable of both °C and °F operation. The user may at any time select which mode to use. When switched, all temperature displays, including hardcopy output, will be affected. The temperature data sent to the hardcopy device will be followed by C or F as applicable.

\* To switch to °C, type the following keystrokes:



\* To switch to °F, type these keystrokes:



NOTE - The power up default mode is °F.

SUMMARY OF DISPLAY COMMANDS

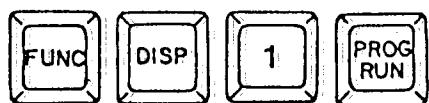

% Relative Humidity

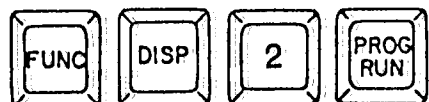

Dewpoint Temperature

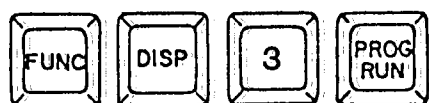

Dry Bulb Temperature

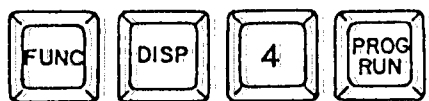

Wet Bulb Temperature



Dry Bulb Resistance in Ohms

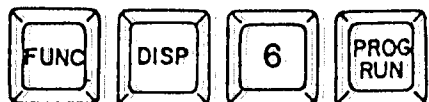

Wet Bulb Resistance in Ohms



Time

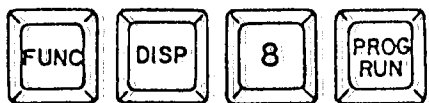

Date

SUMMARY OF ON/OFF COMMANDS

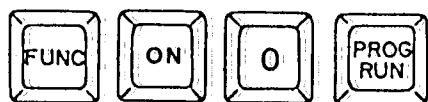

Enable Auto Mode



Disable Auto Mode

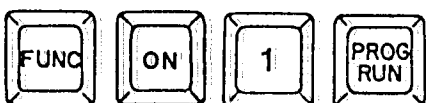

Turn Probe ON Manually

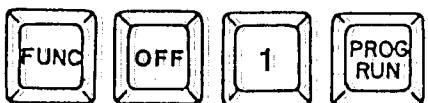

Turn Probe OFF Manually



Enable Printer Output

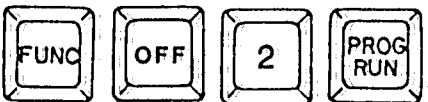

Disable Printer Output

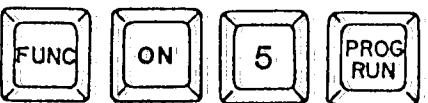



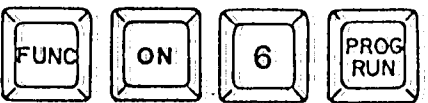

































Switch to °C



Switch to °F

SUMMARY OF SET COMMANDS

									Interval	
										Pressure
									Time	
									Date	

## PROBE WICK CHANGEOUT INSTRUCTIONS

The CK-1 Wick Changeout Kit is provided to easily change wicks in the sensing probe. Wick changes should be performed after forty hours of operation, or more often, particularly if the instrument is in a dirty environment. A replacement wick supply should be ordered from Thunder Scientific Corporation in advance of the need and kept on hand.

Order PW-101 Probe Wick

\$10.00 each

Suggested Stock: 25

Minimum Order: \$50.00

F.O.B. Albuquerque, New Mexico 87123

- 1) Place probe upside down upon two blocks of wood or other material, one on each side of the probe handle.
- 2) Remove reservoir plug and rubber feet.
- 3) Gently pry reservoir cover with plastic tool and remove.
- 4) Carefully remove the four housing retainer screws located in the corners of the probe; They join the two halves of the probe.
- 5) Gently remove bottom half of probe housing, feeding the wick through the teflon wick tube. Keep the teflon air sleeve in place during removal.  
NOTE - Blower motor is also loose once housing is removed.
- 6) Lift teflon air sleeve up and off the sensor mounts, taking care to feed the wick through the air sleeve avoiding any lateral movement and undue strain upon the sensor.
- 7) The sensor and wick are now in the open where the wick may be removed. Using the dropper provided, apply several drops of ethyl alcohol to the portion of the wick covering the sensor. Allow to soak for approximately one minute, replenishing the alcohol as evaporation occurs.
- 8) Using one of the picks provided, gently probe the wick covering the sensor to loosen.
- 9) Using the curved tweezers provided, very gently push the wick up on itself or up on the sensor, assisting with the other hand from the reservoir side. (The wick construction is very similar to a "Chinese finger puzzle" in that pushing tends to release it where pulling only

tightens the wick and compounds the problem of removal). The wick should expand. When this occurs, use the tweezers to slide the wick from the sensor.

IMPORTANT! - If wick is frozen to the sensor with deposits due to contaminated water, DO NOT FORCE. This will break the sensor leads, causing expensive repair costs. If alcohol does not loosen the deposit, return to Thunder Scientific Corporation for removal. Thunder Scientific is not responsible for lead breakage and/or sensor replacement if such occurs.

If a wick changeout schedule is maintained, this problem will not occur.

- 10) Apply finger cots supplied to the thumb and index finger of each hand. Soak a clean cloth with alcohol and remove all traces of talcum from the outer surfaces. If this is not done, the wick becomes contaminated.
- 11) The replacement wicks are supplied in a sealed vial of alcohol. Remove wick from the vial.
- 12) Using the blue taper tool provided, push the wick onto the tool approximately one inch or more, causing expansion by pushing on the wick.
- 13) Remove from tool and clip frayed end square.
- 14) Slide wick gently onto sensor and over the teflon to the shoulder.
- 15) Using the dropper, apply several drops of water on the wick at the sensor. Note wick expands slightly, indicating water retention. Gently form the wick around end of sensor and flatten between the sensor and wick tube to offer minimum wind resistance.
- 16) Feed wick thru teflon air sleeve, slide sleeve over teflon sensor mounts, and seat it on the probe half.
- 17) Feed wick thru wick tube in bottom probe half and mate the probe halves. Coil wick inside reservoir and replace cover.
- 18) Replace four corner screws, rubber feet, and reservoir plug.

### FACTORY CERTIFICATION & RECERTIFICATION

Factory certification is initially provided with each new instrument on a no-charge basis. Certification is good for one year or longer; However, the instrument should be recertified by the factory on a regular yearly basis. This is done for a calibration charge of \$200.00 per temperature and humidity point. Generally, three temperature and humidity points are sufficient. If the instrument requires more than general cleaning, a reconditioning charge of \$150.00 is required.

### NBS CERTIFICATION & RECERTIFICATION

If it is desired that the instrument be certified by the National Bureau of Standards (NBS), all NBS charges are passed net to the customer, plus F.O.B. charges to and from, plus insurance coverage.

In the case of NBS certification, Thunder Scientific Corporation does require that the instrument be shipped direct from Thunder to NBS and returned prior to shipment to the customer. The same is required for recertification. The instrument should be returned to Thunder Scientific for inspection and reconditioning prior to recertification by the Bureau.

\*\*\*\*\*

### SUMMARY

Your Thunder Scientific psychrometer is a precise laboratory standard and should be treated accordingly. Good maintenance will result in many years of service.

Should any problems or question arise relative to your instrument, direct all correspondence to the following address:

Thunder Scientific Corporation  
623 Wyoming S.E.  
Albuquerque, New Mexico 87123

Or call collect (505) 265-8701

## PRINTER/COMPUTER INTERFACE OPTIONS

There are three computer/printer interface options currently available for the 4A-1-MP Psychrometer. Based upon which option your unit has, the 25 pin output connector will match one of the below listed pinouts.

DB-25 Pins	Trendcom Parallel	Centronics Parallel	RS-232 Serial
1	Ground	Strobe	
2		D0	
3		D1	XMIT Data
4		D2	* RTS
5		D3	* CTS
6	D1	D4	** DSR
7	D3	D5	Ground
8	D5	D6	
9	D7	D7	
10			
11		Busy	
12			
13			
14	Busy	Ground	
15		Ground	
16		Ground	
17	Strobe	Ground	
18	D0	Ground	
19	D2	Ground	
20	D4	Ground	** DTR
21	D6		
22			
23			
24			
25			

No special cables should be required. Each of the output options are configured so as to make the proper connections with the peripheral device using only a flat ribbon cable and the appropriate insulation displacement connectors. (ie DB-25, 36 pin Centronics, 20 pin Dual Row IDC, etc.)

Interface cables are available from Thunder Scientific Corporation.

### Serial option notes:

\* DB-25 pins 4 and 5 are tied together inside the 4A-1-MP.

\*\* DB-25 pins 6 and 20 are tied together inside the 4A-1-MP. Either of these lines may be used as a BUSY/READY handshake line. If handshaking is used, the receiving device should be able to accept one more full character in addition to the one currently being sent due to the double-buffered nature of the UART used within the 4A-1-MP.

Signals greater than +5 volts = READY  
Signals greater than -5 volts = BUSY

If pins 6 and 20 are left unterminated, READY is assumed.



THUNDER SCIENTIFIC CORP.  
ALBUQUERQUE, NEW MEXICO

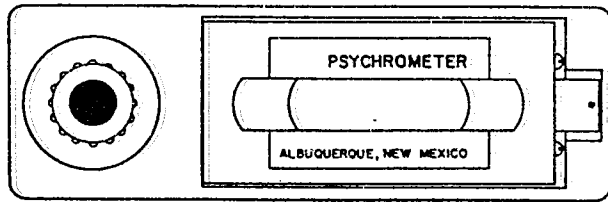
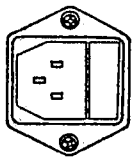
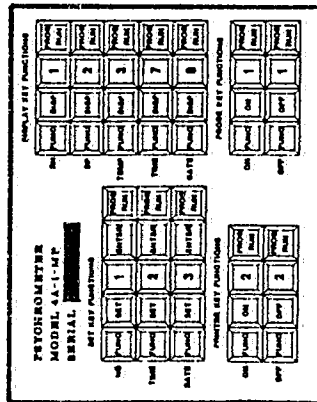
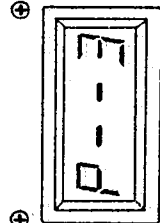
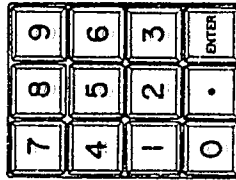
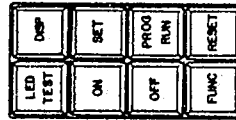
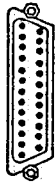

TOLERANCES		REVISIONS		THUNDER SCIENTIFIC	
NO.	DATE	NO.	DATE	REV.	BY
1		1			
2		2			
3		3			
4		4			

FRONT PANEL DETAIL (4A-1-MP)

SCALE: FULL  
DATE: 12-14-83  
DRAWN BY: [Signature]  
CHECKED BY: [Signature]  
DATE: 12-14-83  
JOB NO: 44-1-MP

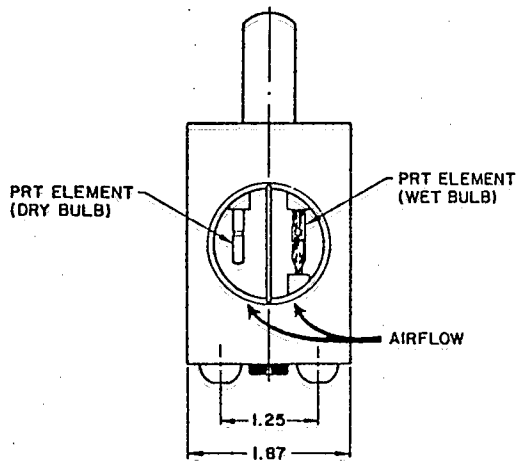

FRONT VIEW

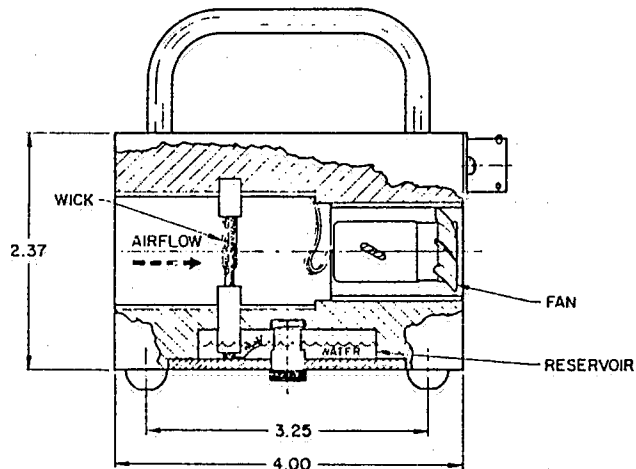

SIDE VIEW

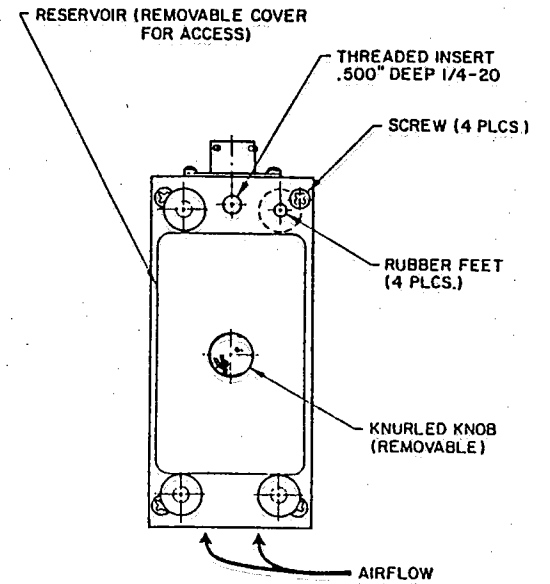

BOTTOM VIEW

THUNDER SCIENTIFIC CORP					
623 WYOMING S.E.		ALBUQUERQUE, NEW MEXICO 87123			
TOLERANCES		REVISIONS		PSYCHROMETER	
INTEGRAL DIMENSIONS	NO	DATE	BY	MODEL 4A-IMP	
DECIMAL	1			RESERVOIR/SENSOR	
FRACTIONAL	2			DETAIL DRAWING	
ANGULAR	3			DRAWN BY <i>Dina</i>	SCALE 1" = 1"
	4			CHECKED <i>STL</i>	DATE 2/28/83
	5			TRACED	DRAWING NO. NA
	6				DE83C023

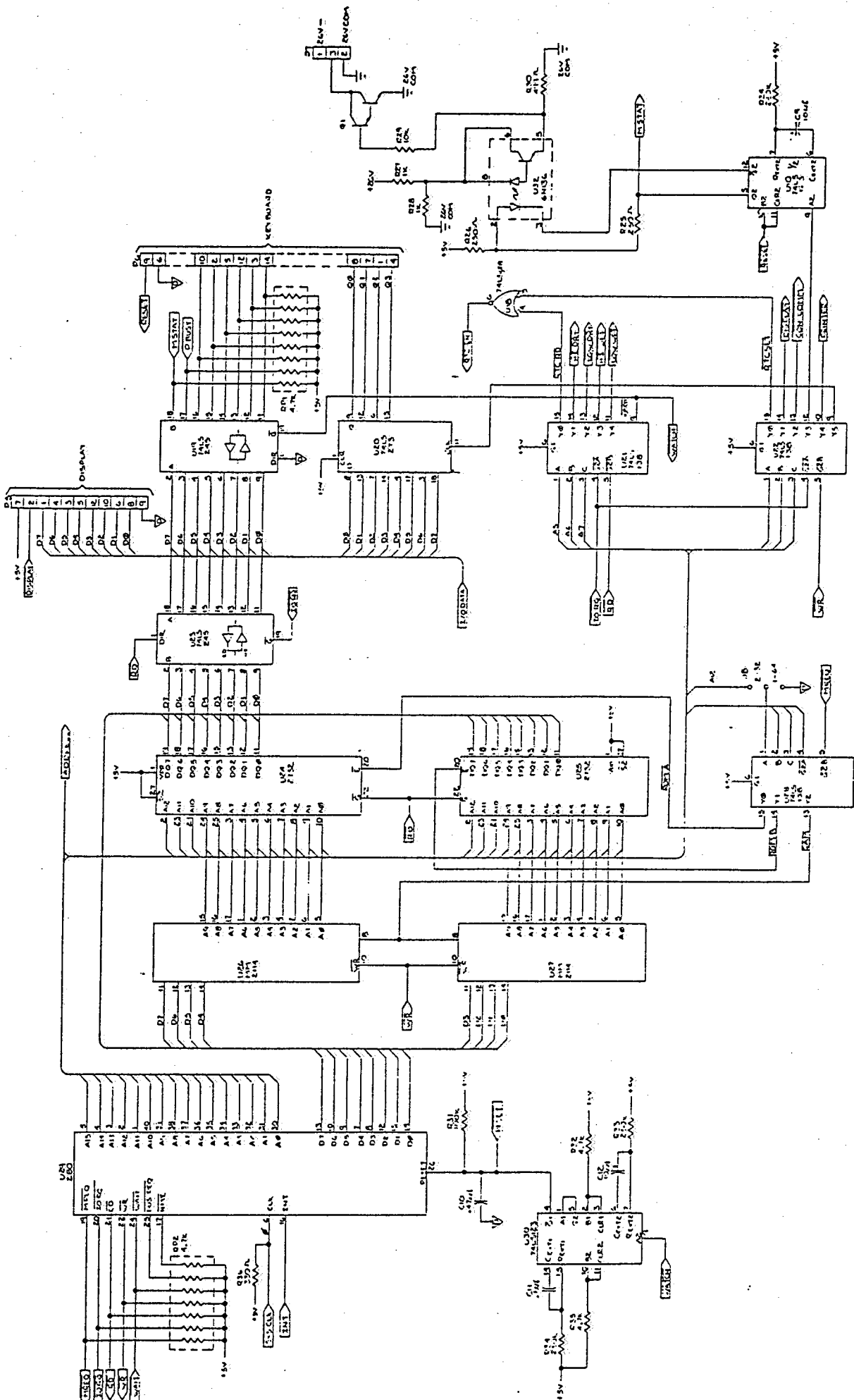

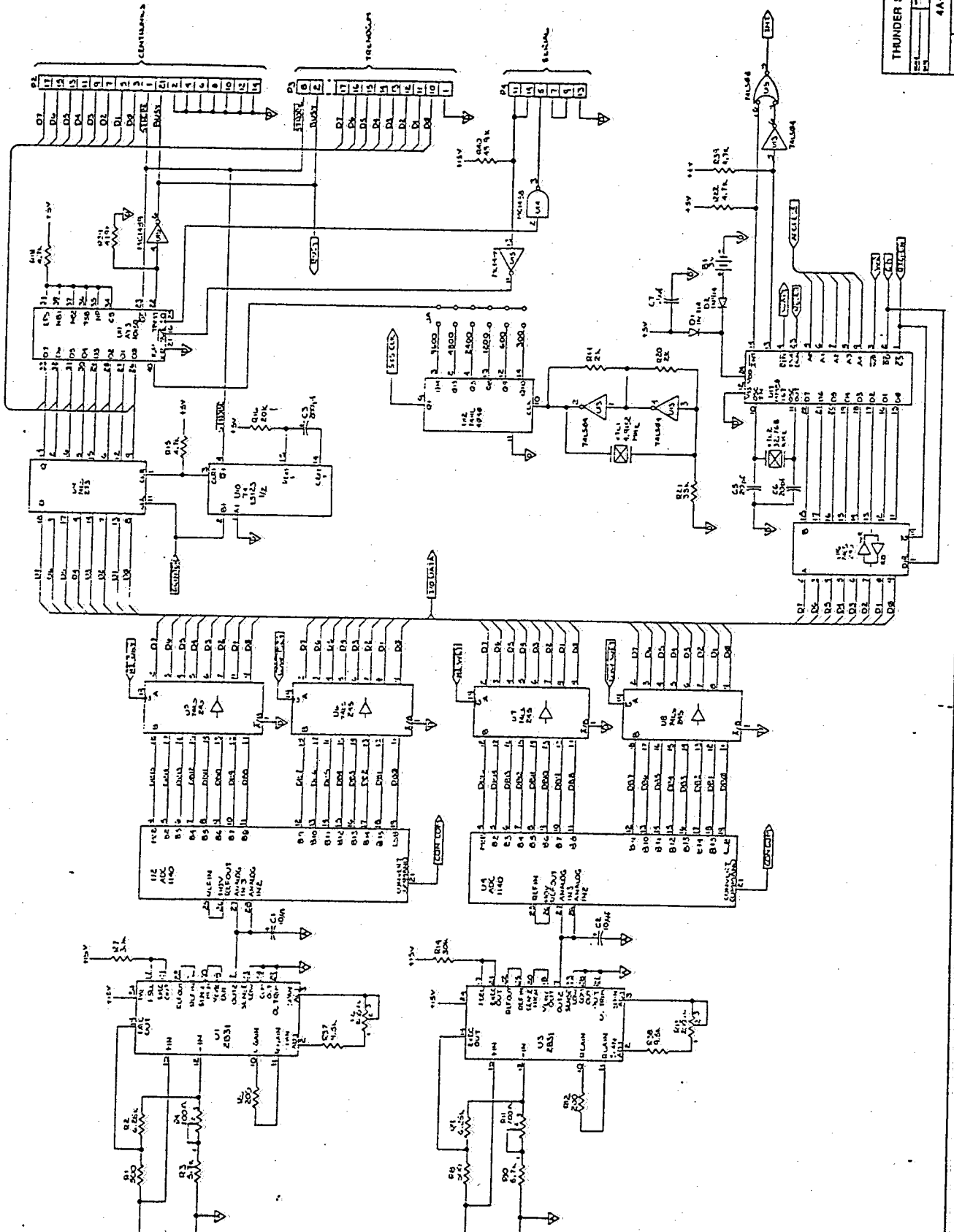

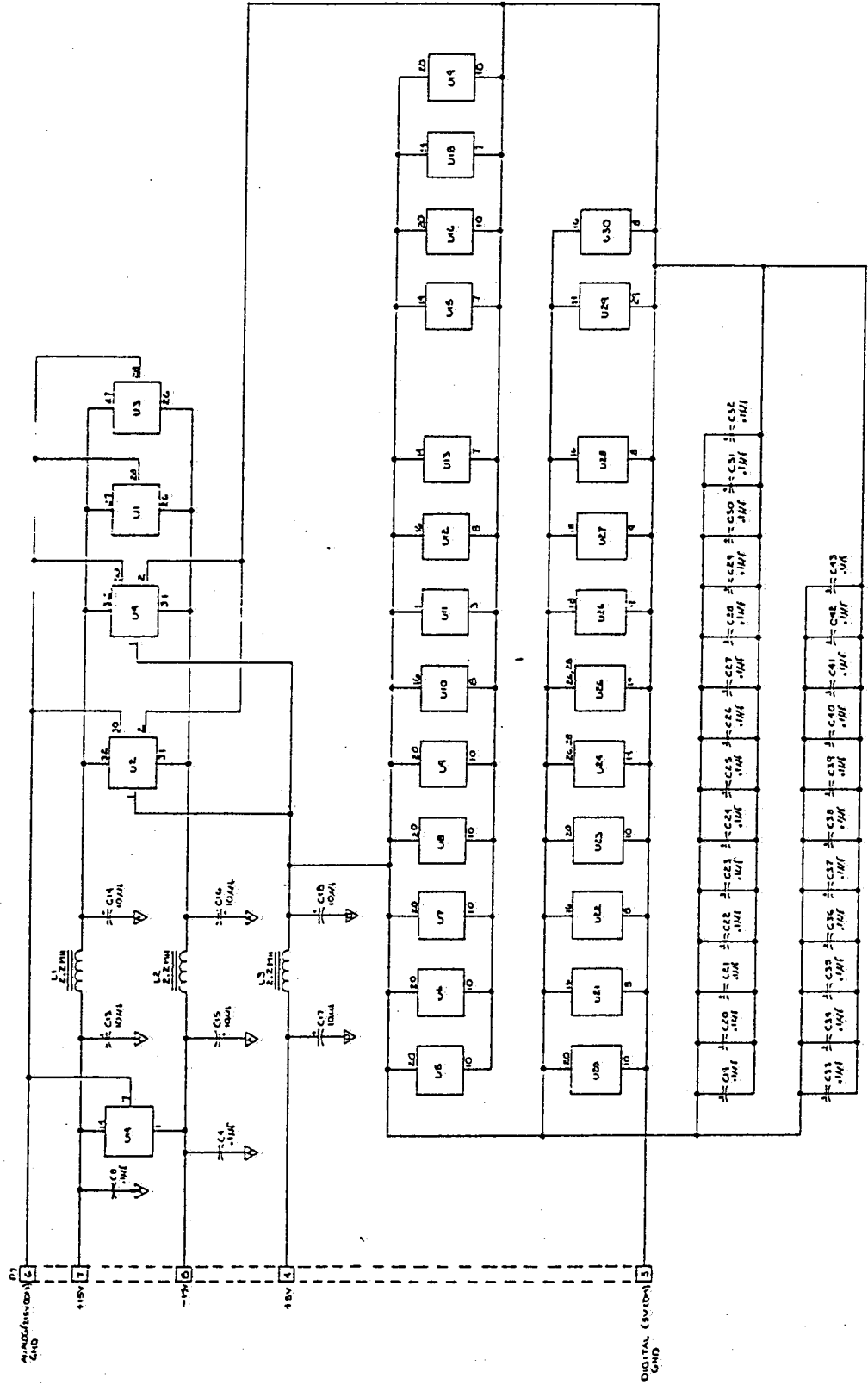

REVISIONS			
LTR	DESCRIPTION	DATE	APPROVED

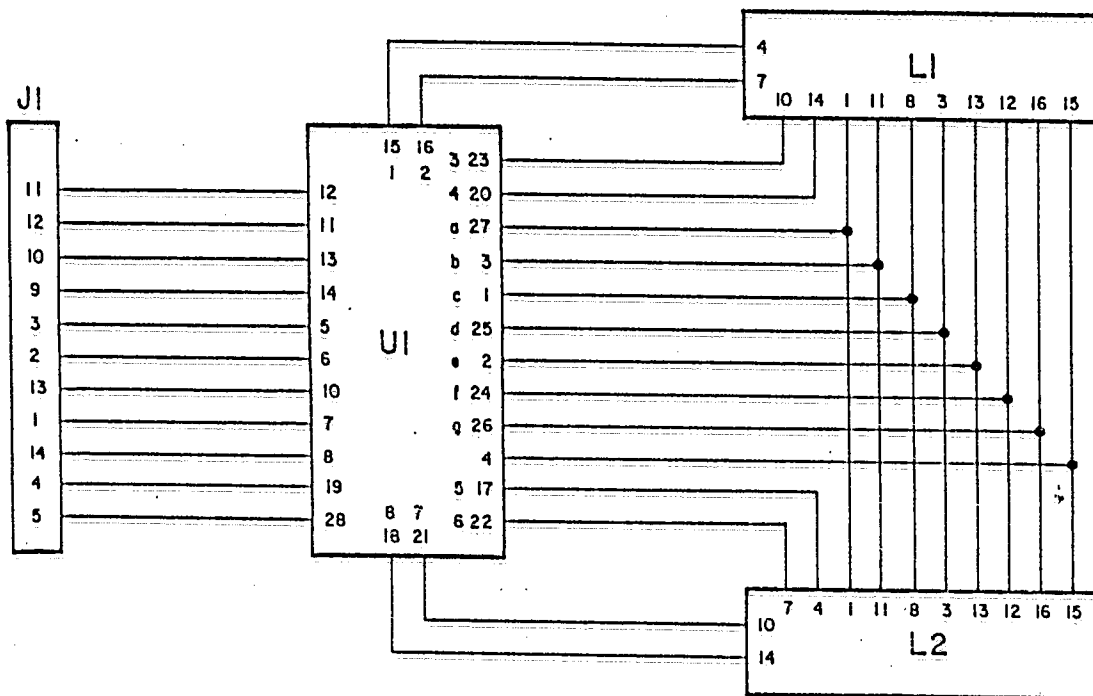

NOTES:

1. U1 IS AN LED DRIVER SYSTEM.
2. L1 AND L2 ARE LED DISPLAYS.
3. J1 IS A 14-PIN CONNECTOR, SHOULD CONNECT WITH J3 OF MOTHER BOARD BY CABLE.
4. ADD A .1 MF CAP. BETWEEN PIN 9 & 19 OF U1.

THUNDER SCIENTIFIC CORP			
823 WYOMING S.E.		ALBUQUERQUE, NEW MEXICO 87133	
TOLERANCES UNLESS OTHERWISE SPECIFIED		4A-1-MP	
FRACTIONS DEC ANGLES			
±	±	±	±
APPROVALS	DATE	NEW DISPLAY SCHEMATIC	
DRAWN <i>D.A.</i>	<i>12-15-83</i>		
CHECKED		SCALE	DRAWING NO.
		NA	B S83A130
DO NOT SCALE DRAWING			SHEET 1 OF 1

REVISIONS			
LTR	DESCRIPTION	DATE	APPROVED

PROBE 1/2

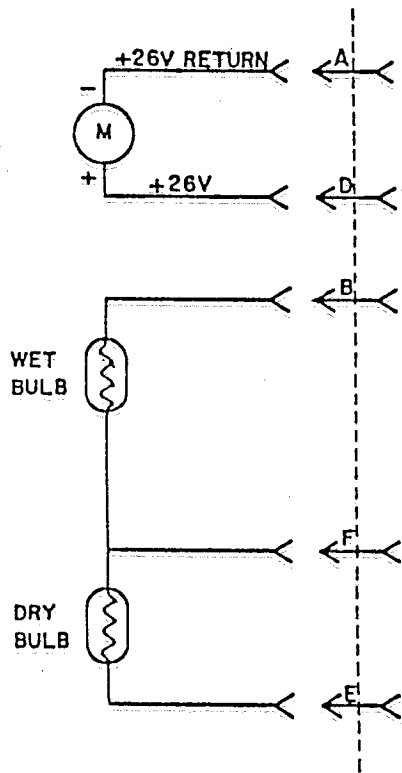

CABLE 1/2

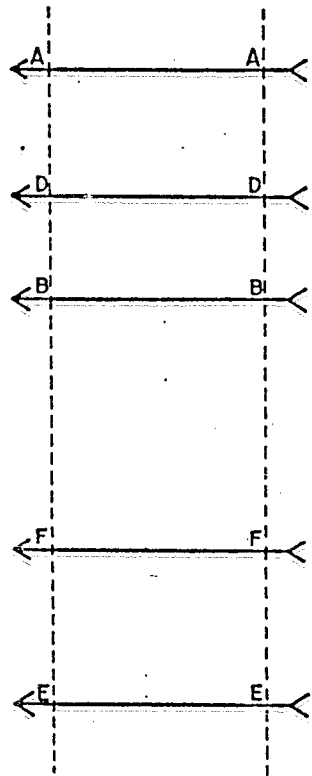

MAINFRAME

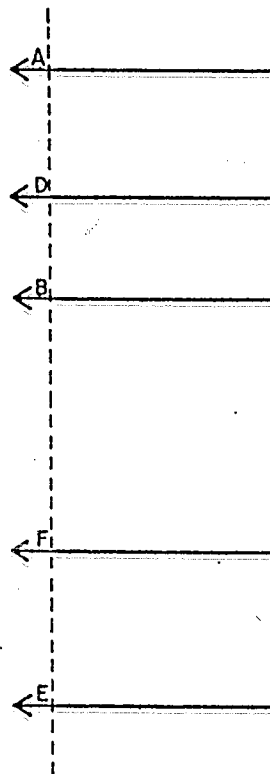

 <b>THUNDER SCIENTIFIC CORP</b> 623 WYOMING S.E. ALBUQUERQUE, NEW MEXICO 87123		<b>MODEL 4A-I-MP</b>		
				<b>SCHEMATIC PROBE CONNECTOR</b>
TOLERANCES UNLESS OTHERWISE SPECIFIED FRACTIONS DEC ANGLES * * *	APPROVALS DRAWN <b>DRA</b> CHECKED	DATE <b>1-3-81</b>	SCALE <b>B</b>	DRAWING NO. <b>S83B131</b>
DO NOT SCALE DRAWING			SHEET	





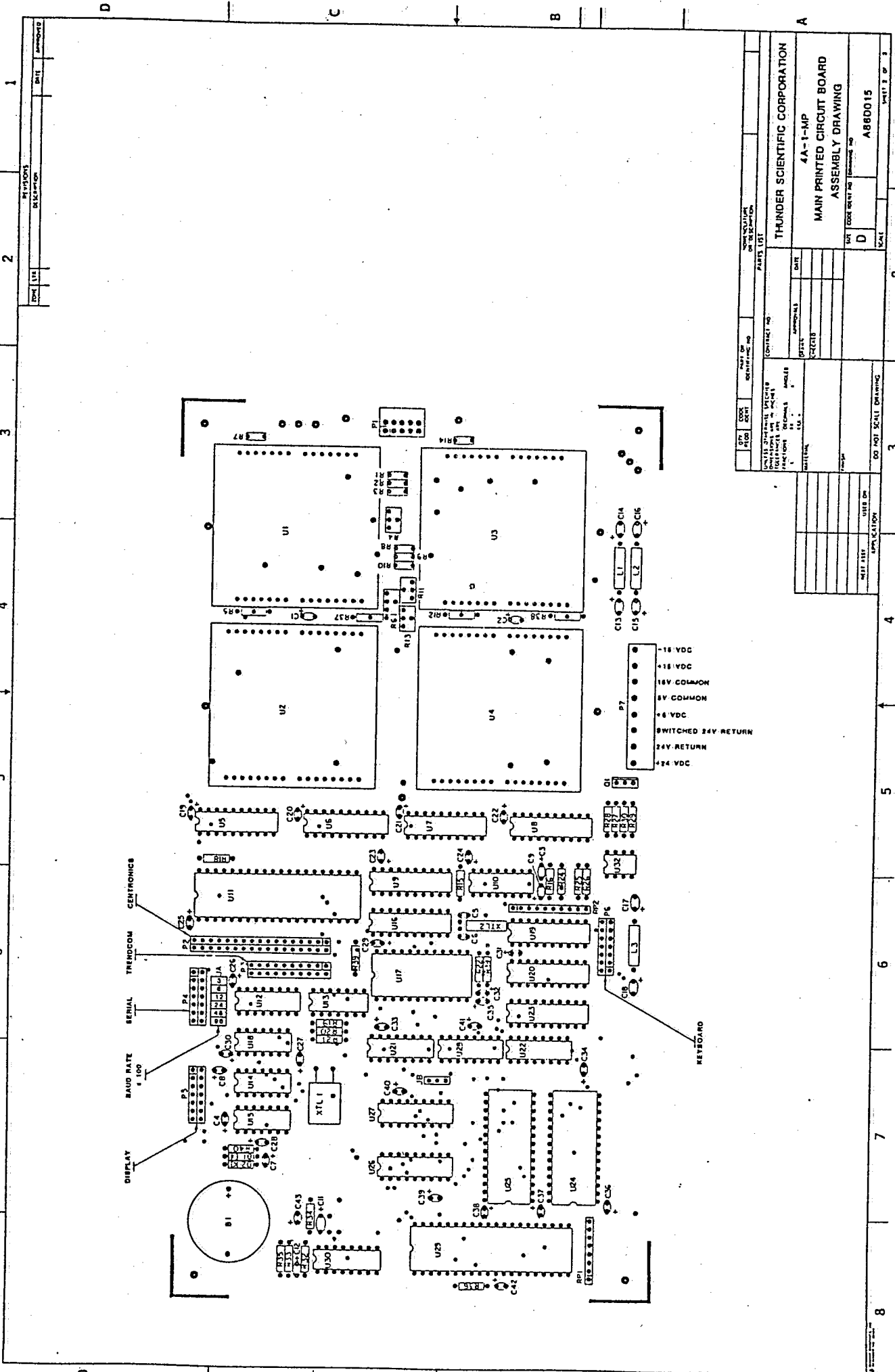

REV	DATE	DESCRIPTION
1		

THUNDER SCIENTIFIC CORPORATION	
4A-1-MP	
MAIN PRINTED CIRCUIT BOARD	
ASSEMBLY DRAWING	
DATE	SCALE
D	1
1	1

DATE	SCALE
D	1
1	1

DATE	SCALE
D	1
1	1

DATE	SCALE
D	1
1	1

DATE	SCALE
D	1
1	1

DATE	SCALE
D	1
1	1