

User's Guide

Agilent Technologies 8922M/S GSM Test Set

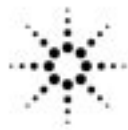

Agilent Technologies

Agilent Part No. 08922-90211

Printed in UK

January 1998

© Copyright 1998, Agilent Technologies. All rights reserved. No part of this manual may be reproduced in any form or by any means (including electronic storage and retrieval or translation into a foreign language) without prior agreement and written consent from Agilent Technologies Inc. as governed by United States and international copyright laws.

Contents

| | |
|---|------|
| Declaration of Conformity..... | v |
| Sales and Service Offices..... | viii |
| Agilent Technologies 8922M/S Documentation Description..... | x |
| Typeface Conventions..... | xi |
| 1 Installing Your Agilent 8922M/S | |
| Using this Chapter | 1-2 |
| Fuses and Power Cords | 1-3 |
| Installation Overview | 1-5 |
| General Information..... | 1-8 |
| 2 Making Measurements | |
| Using This Chapter | 2-2 |
| Agilent Technologies 8922M/S Operating Modes | 2-3 |
| ACTIVE CELL..... | 2-5 |
| TEST MODE..... | 2-9 |
| CW GENERATOR | 2-12 |
| Measurements | 2-13 |
| If You Have Problems with a Measurement | 2-30 |
| Advanced Features..... | 2-39 |
| 3 Verifying Performance | |
| About This Chapter..... | 3-2 |
| Setting up the Tests | 3-3 |
| Getting the Right Equipment | 3-4 |
| Installing and Operating the Software | 3-5 |
| Understanding the Tests..... | 3-7 |
| Understanding Test Failures | 3-13 |
| Agilent Technologies 8922M/S Specifications..... | 3-14 |

Contents

4 Screens

| | |
|--|------|
| Field Types | 4-2 |
| Audio | 4-4 |
| Bit Error | 4-8 |
| Bit Error 2 | 4-11 |
| Cell Configuration - GSM 900 | 4-16 |
| Cell Configuration - E-GSM, DCS 1800, PCS 1900 | 4-22 |
| Cell Control - Active Cell | 4-27 |
| Cell Control - Active Cell + | 4-31 |
| Cell Control - Test Mode | 4-33 |
| Cell Control - CW Generator | 4-35 |
| Cell Control 2 | 4-37 |
| Configure | 4-49 |
| CW Measurement | 4-54 |
| Fast Bit Error | 4-56 |
| I/O Configuration | 4-59 |
| Logging | 4-63 |
| Measurement Sync | 4-64 |
| Message | 4-69 |
| MS Information / Signaling | 4-70 |
| Oscilloscope, Main Controls | 4-75 |
| Oscilloscope, Trigger Controls | 4-77 |
| Oscilloscope, Marker Controls | 4-80 |
| Output RF Spectrum, Main View (Option 006 Only) | 4-82 |
| Output RF Spectrum, Trace View (Option 006 Only) | 4-84 |
| Phase and Frequency Error - Multiburst OFF | 4-86 |
| Phase and Frequency Error - Multi-burst ON | 4-88 |
| Phase/Freq, Phase Err | 4-91 |
| Phase/Freq, Data Bits | 4-93 |
| Pwr Ramp: Rise Edge | 4-95 |
| Pwr Ramp, Top 2 dB | 4-97 |

Contents

| | |
|--|-------|
| Pwr Ramp, Fall Edge | 4-99 |
| Pwr Ramp: Summary | 4-101 |
| Pwr Ramp: Pulse (Option 006 Only) | 4-104 |
| Pwr Ramp: Pulse Rise (Option 006 Only) | 4-107 |
| Pwr Ramp: Pulse Fall (Option 006 Only) | 4-109 |
| RF Generator / RF Analyzer (AF Gen) | 4-111 |
| RF Generator / RF Analyzer (RF Analyzer) | 4-112 |
| RF Generator / RF Analyzer (RF Gen) | 4-115 |
| Service | 4-118 |
| SMS Cell Broadcast | 4-119 |
| Spectrum Analyzer, Main Controls (Option 006 Only) | 4-122 |
| Spectrum Analyzer, RF Gen Controls (Option 006 Only) | 4-124 |
| Spectrum Analyzer, Marker Controls (Option 006 Only) | 4-125 |
| Spectrum Analyzer, Auxiliary Controls | 4-127 |
| Tests | 4-129 |

5 Keys

| | |
|---------------------|------|
| Key Map | 5-2 |
| Function Keys | 5-3 |
| Local Keys | 5-10 |
| Global Keys | 5-11 |
| Units Keys | 5-12 |

Contents

6 Connectors

| | |
|--|------|
| Front-Panel Connectors of the Agilent Technologies 8922M/S | 6-2 |
| Rear-Panel Connectors of the Agilent Technologies 8922M/S..... | 6-10 |
| Signal Descriptions for SYSTEM BUS | 6-18 |
| Timing Diagrams..... | 6-27 |

7 Messages

| | |
|--|------|
| Communication Failures | 7-2 |
| Firmware Error | 7-3 |
| Sync Status | 7-4 |
| Protocol Error Messages | 7-5 |
| Timers..... | 7-6 |
| Disconnects | 7-8 |
| Protocol Log Examples Of Typical Calls..... | 7-11 |
| Monitoring For Protocol Failure And Recovery During Test. | 7-12 |

8 Instrument BASIC

| | |
|--|------|
| Agilent Technologies 8922M/S Instrument BASIC Overview | 8-2 |
| Configuration and Instrument Control | 8-4 |
| Loading, Storing, and Running | 8-10 |
| Entering and Editing Programs | 8-16 |
| Memory Cards..... | 8-20 |
| Programming and Using the TESTS Subsystem..... | 8-26 |

Contents

A APPENDIX A

| | |
|---|------|
| Purpose | A-2 |
| Equipment Required | A-3 |
| Connecting the Agilent 8922M to the HP/Agilent 37900D | A-4 |
| Setting Up the Agilent Technologies 8922M | A-5 |
| Setting Up the HP/Agilent 37900D | A-6 |
| How to Obtain a Protocol Log | A-8 |
| Additional Information | A-11 |
| Protocol Log of a Typical Call..... | A-13 |

B Glossary

| | |
|-------|-----|
| | B-2 |
|-------|-----|

Index 1

Contents

Warranty

This Agilent Technologies instrument product is warranted against defects in material and workmanship for a period of one year from date of shipment. During the warranty period, Agilent Technologies will at its option, either repair or replace products which prove to be defective.

For warranty service or repair, this product must be returned to a service facility designated by Agilent Technologies. Buyer shall prepay shipping charges to Agilent Technologies and Agilent Technologies shall pay shipping charges, duties, and taxes for products returned to Agilent Technologies from another country.

Agilent Technologies warrants that its software and firmware designated by Agilent Technologies for use with an instrument will execute its programming instructions when properly installed on that instrument. Agilent Technologies does not warrant that the operation of the instrument, or software, or firmware will be uninterrupted or error free.

Limitation of Warranty

The foregoing warranty shall not apply to defects resulting from improper or inadequate maintenance by Buyer, Buyer-supplied software or interfacing, unauthorized modification or misuse, operation outside of the environmental specifications for the product, or improper site preparation or maintenance.

NO OTHER WARRANTY IS EXPRESSED OR IMPLIED. AGILENT TECHNOLOGIES SPECIFICALLY DISCLAIMS THE IMPLIED WARRANTIES OF MERCHANTABILITY AND FITNESS FOR A PARTICULAR PURPOSE.

Limitation of Remedies and Liability

THE REMEDIES PROVIDED HEREIN ARE BUYER'S SOLE AND EXCLUSIVE REMEDIES. AGILENT TECHNOLOGIES SHALL NOT BE LIABLE FOR ANY DIRECT, INDIRECT, SPECIAL, INCIDENTAL, OR CONSEQUENTIAL DAMAGES, WHETHER BASED ON CONTRACT, TORT, OR ANY OTHER LEGAL THEORY.

Responsibilities of the Customer

The customer shall provide;

- 1 Access to the products during the specified periods of coverage to perform maintenance.
- 2 Adequate working space around the products for servicing by Agilent Technologies personnel.
- 3 Access to and use of all information and facilities determined necessary by Agilent Technologies to service and/or maintain the products. (In so far as these items may contain proprietary or classified information, the customer shall assume full responsibility for safeguarding and protection from wrongful use.)
- 4 Routine operator maintenance and cleaning as specified in the Agilent Technologies Operating and Service Manuals.
- 5 Consumables such as paper, disks, magnetic tapes, ribbons, inks, pens, gases, solvents, lamps, filters, fuses, seals, etc.

Certification

Agilent Technologies certifies that this product met its published specifications at the time of shipment from the factory. Agilent Technologies further certifies that its calibration measurements are traceable to the United States National Bureau of Standards and Technology, to the extent allowed by the Bureau's calibration facility, and to the calibration facilities of other International Standards Organization members.

Assistance

Product maintenance agreements and other customer assistance agreements are available for Agilent Technologies products.

For any assistance, contact your local Agilent Sales and Service Office. For a list of contact information, see "Sales and Service Offices" on page ix.

Notices

The material contained in this document is subject to change without notice. AGILENT TECHNOLOGIES MAKES NO WARRANTY OF ANY KIND WITH REGARD TO THIS MATERIAL, INCLUDING, BUT NOT LIMITED TO, THE IMPLIED WARRANTIES OF MERCHANTABILITY AND FITNESS FOR A PARTICULAR PURPOSE. Agilent Technologies inc. shall not be liable for errors contained herein or for incidental or consequential damages in connection with the furnishing, performance or use of this material.

Agilent Technologies assumes no responsibility for the use or reliability of its software on equipment that is not furnished by Agilent Technologies.

Restricted Rights Legend

If Software is for use in the performance of a U.S. Government prime contract or subcontract, Software is delivered and licensed as "Commercial computer software" as defined in DFAR 252.227-7014 (June 1995), or as a "commercial item" as defined in FAR 2.101(a) or as "Restricted computer software" as defined in FAR 52.227-19 (June 1987) or any equivalent agency regulation or contract clause. Use, duplication or disclosure of Software is subject to Agilent Technologies' standard commercial licenseterms, and non-DOD Departments and Agencies of the U.S. Government will receive no greater than Restricted Rights as defined in FAR 52.227- 19(c)(1-2) (June 1987). U.S. Government users will receive no greater than Limited Rights as defined in FAR 52.227-14 (June 1987) or DFAR 252.227-7015 (b)(2) (November 1995), as applicable in any technical data. Copyright 200X Agilent Technologies Inc. All Rights Reserved.

Statement of Compliance

This product conforms to EN61010-1(1993) / IEC 1010-1(1990) +A1(1992) +A2(1994) / CSA C22.2 No. 1010.1(1993) Safety requirements for Electrical Equipment for Measurement, Control and Laboratory Use, and has been supplied in a safe condition. The instruction documentation contains information and warnings which must be followed by the user to ensure safe operation and to maintain the instrument in a safe condition.

Electromagnetic Compatibility (EMC) Information

This product has been designed to meet the protection requirements of the European Communities Electromagnetic Compatibility (EMC) directive:

EN55011:1991 (Group 1, Class A)

EN50082-1:1992

- IEC 1000-4-2 (1995) ESD

- IEC 1000-4-3 (1995) Radiated Susceptibility

- IEC 1000-4-4 (1995) EFT

In order to preserve the EMC performance of this product, any cable which becomes worn or damaged, must be replaced with the same type and specification.

Sound Emission

Manufacturer's Declaration

This statement is provided to comply with the requirements of the German Sound Emission Directive, from 18 January 1991.

This product has a sound pressure emission (at the operator position) < 70 dB(A).

- Sound Pressure $L_p < 70$ dB(A).
- At Operator Position.
- Normal Operation.
- According to ISO 7779:1988/EN 27779:1991 (Type Test).

Herstellerbescheinigung

Diese Information steht im Zusammenhang mit den Anforderungen der Maschinenlärminformationsverordnung vom 18 Januar 1991.

- Schalldruckpegel $L_p < 70$ dB(A).
- Am Arbeitsplatz.
- Normaler Betrieb.
- Nach ISO 7779:1988/EN 27779:1991 (Typprüfung).

Declaration of Conformity

according to ISO/IEC Guide 22 and EN45014

| | |
|---|---|
| Manufacturer's Name: | Agilent Technologies. |
| Manufacturer's Address: | Agilent Technologies South Queensferry West Lothian, EH30 9TG Scotland, United Kingdom |
| Declares that the product | |
| Product Name: | GSM MS Test Set |
| Model Numbers: | Agilent Technologies 8922M and 8922S |
| Product Options: | This declaration covers all options of the above products as detailed in TCF A-5951-9852-02 |
| Conforms with the protection requirements of European Council Directive 89/336/EEC on the approximation of the laws of the member states relating to electromagnetic compatibility. | |
| Against EMC test specifications EN 55011:1991 (Group 1, Class A) and EN 50082-1:1992 | |
| As Detailed in: | Electromagnetic Compatibility (EMC) Technical Construction File (TCF) No. A-5951-9852-02 |
| Assessed by: | Dti Appointed Competent Body EMC Test Centre, GEC-Marconi Avionics Ltd., Maxwell Building, Donibristle Industrial Park, KY11 5LB Scotland, United Kingdom |
| Technical Report Number:6893/2200/CBR, dated 23 September 1997 | |
| Supplementary Information: | |
| The product conforms to the following safety standards: | EN 61010-1(1993) / IEC 1010-1(1990) +A1(1992) +A2(1994) CSA-C22.2 No. 1010.1-93 EN 60825-1(1994) / IEC 825-1(1993) |
| The product herewith complies with the requirements of the Low Voltage Directive 73/23/EEC, and carries the CE-marking accordingly. | |
| South Queensferry, Scotland | 17 November 1997 |
| <i>Location</i> | <i>Date</i> |
| | <i>R.M. Evans</i> |
| | R.M. Evans / Quality Manager |

Safety Information

The following general safety precautions must be observed during all phases of operation of this instrument. Failure to comply with these precautions or with specific warnings elsewhere in this manual violates safety standards of design, manufacture, and intended use of the instrument. Agilent Technologies Inc. assumes no liability for the customer's failure to comply with these requirements.

GENERAL

This product is a Safety Class 1 instrument (provided with a protective earth terminal). The protective features of this product may be impaired if it is used in a manner not specified in the operation instructions. All Light Emitting Diodes (LEDs) used in this product are Class 1 LEDs as per IEC 60825-1.

ENVIRONMENTAL CONDITIONS

This instrument is intended for indoor use in an installation category II, pollution degree 2 environment. It is designed to operate at a maximum relative humidity of 95% and at altitudes of up to 2000 meters. Refer to the specifications tables for the ac mains voltage requirements and ambient operating temperature range.

BEFORE APPLYING POWER

Verify that the product is set to match the available line voltage, the correct fuse is installed, and all safety precautions are taken. Note the instrument's external markings described under "Safety Symbols".

GROUND THE INSTRUMENT

To minimize shock hazard, the instrument chassis and cover must be connected to an electrical protective earth ground. The instrument must be connected to the ac power mains through a grounded power cable, with the ground wire firmly connected to an electrical ground (safety ground) at the power outlet. Any interruption of the protective (grounding) conductor or disconnection of the protective earth terminal will cause a potential shock hazard that could result in personal injury.

FUSES

Only fuses with the required rated current, voltage, and specified type (normal blow, time delay, etc.) should be used. Do not use repaired fuses or short-circuited fuse holders. To do so could cause a shock or fire hazard.

DO NOT OPERATE IN AN EXPLOSIVE ATMOSPHERE

Do not operate the instrument in the presence of flammable gases or fumes.

DO NOT REMOVE THE INSTRUMENT COVER

Operating personnel must not remove instrument covers. Component replacement and internal adjustments must be made only by qualified service personnel.

Instruments that appear damaged or defective should be made inoperative and secured against unintended operation until they can be repaired by qualified service personnel.









WARNING The WARNING sign denotes a hazard. It calls attention to a procedure, practice, or the like, which, if not correctly performed or adhered to, could result in personal injury. Do not proceed beyond a WARNING sign until the indicated conditions are fully understood and met.

Caution The CAUTION sign denotes a hazard. It calls attention to an operating procedure, or the like, which, if not correctly performed or adhered to, could result in damage to or destruction of part or all of the product. Do not proceed beyond a CAUTION sign until the indicated conditions are fully understood and met.

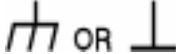
Safety Symbols

Safety Symbols

The following symbols on the instrument and in the manual indicate precautions which must be taken to maintain safe operation of the instrument

| Safety Symbols | |
|---|--|
|  | The Instruction Documentation Symbol. The product is marked with this symbol when it is necessary for the user to refer to the instructions in the supplied documentation. |
|  | Indicates the field wiring terminal that must be connected to earth ground before operating the equipment - protects against electrical shock in case of fault. |
|  | Frame or chassis ground terminal - typically connects to the equipment's metal frame. |
|  | Alternating current (AC) |
|  | Direct current (DC) |
|  | Warning , risk of electric shock. |
| N | Terminal for Neutral conductor on permanently installed equipment. |
| L | Terminal for Line conductor on permanently installed equipment.. |
|  | The CE mark shows that the product complies with all relevant European Legal Directives. |
| ISM 1-A | This is a symbol of an Industrial, Scientific, and Medical Group 1 Class A product. |
|  | The CSA mark is a registered trademark of the Canadian Standards Association, and indicates compliance to the standards defined by them. |
|  | Indicates that a laser is fitted. The user must refer to the manual for specific Warning or Caution information to avoid personal injury or damage to the product. |

Sales and Service Offices

Any adjustment, maintenance, or repair of this product must be performed by qualified personnel. Contact your customer engineer through your local Agilent Technologies Service Center. You can find a list of local service service representatives on the web at:

<http://www.agilent-tech.com/services/English/index.html>

You can also contact one of the following centers and ask for a test and measurement sales representative.

Asia Pacific:

Agilent Technologies
19/F, Cityplaza One, 1111 King's Road,
Taikoo Shing, Hong Kong, SAR
(tel) (852) 2599 7889
(fax) (852) 2506 9233

Japan:

Agilent Technologies Japan Ltd.
Measurement Assistance Center
9-1, Takakura-Cho, Hachioji-Shi
Yokyo, 192-8510
(tel) (81) 426 56 7832
(fax) (81) 426 56 7840

Australia/New Zealand:

Agilent Technologies Australia Pty Ltd
347 Burwood Highway
Forest Hill, Victoria 3131
(tel) 1-800 629 485 (Australia)
(fax) (61 3) 9272 0749
(tel) 0 800 738 378 (New Zealand)
(fax) (64 4) 802 6881

Sales and Service Offices

Canada

Agilent Technologies Canada Inc.
5150 Spectrum Way,
Mississauga, Ontario
L4W 5G1
(tel) 1 877 894 4414

Europe:

Agilent Technologies
Test & Measurement
European Marketing Organisation
P.O. Box 999
1180 AZ Amstelveen
The Netherlands
(tel) (31 20) 547 9999

Latin America:

Agilent Technologies
Latin American Region Headquarters
5200 Blue Lagoon Drive, Suite #950
Miami, Florida 33126
U.S.A.
(tel) (305) 267 4245
(fax) (305) 267 4286

United States:

Agilent Technologies
Test and Measurement Call Center
P.O. Box 4026
Englewood, CO 80155-4026
(tel) 1 800 452 488

In any correspondence or telephone conversations, refer to the power sensor by its model number and full serial number. With this information, the Agilent Technologies representative can quickly determine whether your unit is still within its warranty period.

Agilent Technologies 8922M/S Documentation Description

Documentation Shipped with Your GSM Test Set

Agilent 8922M/S GSM Test Set Quick Start Guide.

This guide gives a brief description on how to make each of the measurements required to test a GSM mobile phone. More detailed descriptions are given in the *Agilent 8922M/S GSM Test Set User's Guide*.

Agilent 8922M/S GSM Test Set User's Guide.

This guide contains information on how to set up the Agilent 8922M/S for making measurements and verifying performance. It also contains more detailed information on each of the screens, keys, and connectors, and how to use the IBASIC facilities available on the Agilent 8922M/S.

Agilent 8922M/S GSM Test Set Performance Test Software.

This 3.5 inch floppy disk allows you to verify the performance of the Agilent 8922. Instructions on how to use this are detailed in the *Agilent 8922M/S GSM Test Set User's Guide*.

Agilent 8922M/S GSM Test Set Programming Reference Guide.

This guide describes, in detail, each of the GPIB command sets for the Agilent 8922M/S.

*Agilent 8922 Multi-Band Test System User's Guide*¹.

This is a supplementary user's guide that describes the additional features found with the Multi-Band test system. The test system is used for testing and making measurements of dual band mobiles.

1. The user's guide is only available with the HP 8922M/S Option 010.

Typeface Conventions

| | |
|-----------------------|--|
| <i>Italics</i> | Italic type is used for emphasis. |
| Display | Display text is used to show examples, fields, and prompts that are displayed on the Agilent 8922M/S screen. |
| PRESET | Keycaps on the Agilent 8922M/S keyboard are enclosed in boxes. |
| Soft keys | Display text is used to show examples, fields, and prompts that are displayed on the Agilent 8922M/S screen. |
| Soft keys | All software listings in this manual can be identified with this font. |

Installing Your Agilent 8922M/S

Using this Chapter

Use the following procedure to get the Agilent Technologies 8922M/S powered-up correctly. After completing this procedure, refer to the Quick Start Guide for an introduction to operating the Agilent Technologies 8922M/S and Chapter 2, “Making Measurements” for more extensive information on using the Agilent Technologies 8922M/S.

- Equipment Supplied**
- Fuse Envelope and Fuse
 - REF OUT/REF IN cable (Option 001 only)
 - Power Cord

CAUTION

To avoid potential injury, ensure that two people are employed in lifting the Agilent 8922M/S out of the box and for any other instrument moves.

NOTE:

If you have the **Agilent 8922M/S Option 010 Multi-Band Test System**, refer to the appropriate *Agilent 8922 Multi-Band User's Guide* for more information on connection and operating differences.

Fuses and Power Cords

CAUTION

Before plugging this instrument into the Mains (line) voltage, be sure the correct voltage on the line voltage selection card has been selected.

Line Voltage and Fuse Selection

Verify that the line voltage selection card is matched to the power source (see Figure 1-1 on page 1-3). Order fuse Agilent part 2110-0083 (2.5 A 250 V, normal blow) for replacement.

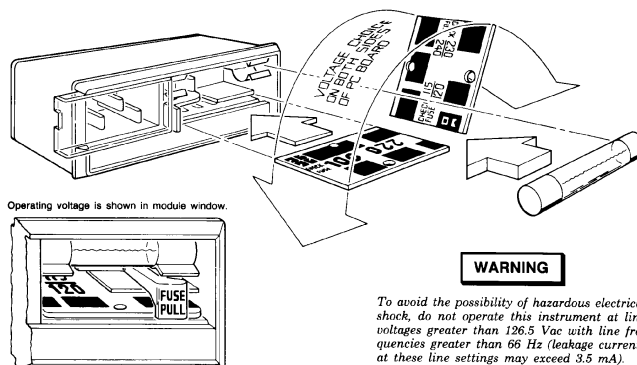

1. Open cover door, pull the FUSE PULL lever and rotate to left. Remove the fuse.
2. Remove the Line Voltage Selection Card. Position the card so the line voltage appears at top-left corner. Push the card firmly into the slot.
3. Rotate the Fuse Pull lever to its normal position. Insert a fuse of the correct value in the holder. Close the cover door.

Figure 1-1

Voltage Selection Card and Fuse Installation











Other Fusing

Non user replaceable fusing on the secondary of this instrument power supply are;

| Fuse | Current | Type | Volatge |
|------|---------|----------|---------|
| F1 | 5A | F 5.0A H | 250V |
| F2 | 3A | F 3.0A H | 250V |
| F3 | 10A | F 10A | 32V |
| F4 | 3A | F 3.0A H | 250V |
| F5 | 0.5A | F 0.5A H | 250V |
| F6 | 3A | F 3.0A H | 250V |

Installing Your Agilent 8922M/S
Fuses and Power Cords

Power Cords

| Plug Type | Cable Agilent Part Number | C D | Plug Description | Cable Length (inches) | Cable Color | Location |
|---|--|------------------|--|-----------------------|--|--|
| 250V  | 8120-1351 8120-1703 | 0 4 | 90°/STR BS1363A* 90°/90° | 90 90 | Mint Gray Mint Gray | United Kingdom, Cyprus, Nigeria, Rhodesia, Singapore |
| 250V  | 8120-1369 8120-0696 | 0 4 | STR/STR NZSS198/ASC112* STR/90° | 79 80 | Gray Gray | Australia, New Zealand |
| 250V  | 8120-1689 8120-1692 | 7 2 | STR/STR* STR/90° | 79 79 | Mint Gray Mint Gray | East and West Europe, Saudi Arabia, Egypt, (unpolarized in many nations) |
| 125V  | 8120-1378 8120-1521 | 1 6 | STR/STR NEMA5-15P* STR/90° | 80 80 | Jade Gray Jade Gray | United States, Canada, Mexico, Philippines, Taiwan, U.S./Canada |
| 100V (Same plug as above) | 8120-1751 | 1 | STR/STR | 90 | Jade Gray | |
| 250V  | 8120-4753 8120-4754 | 2 3 | STR/STR STR/90° | 90 90 | Dark Gray Dark Gray | Japan only Japan only |
| 250V  | 8120-2104 | 3 | STR/STR SEV1011 1959-24507 Type 12 | 79 | Gray | Switzerland |
| 250V  | 8120-2296 8120-3997 | 4 4 | STR/90° STR/90° | 79 177 | Gray Gray | |
| 250V  | 8120-0698 | 6 | STR/STR NEMA6-15P | 90 | Black | United States, Canada |
| 250V  | 8120-2956 8120-2957 8120-3997 | 3 4 4 | 90°/STR 90°/90° STR/STR | 79 | Gray | Denmark |
| 250V  | 8120-4211 8120-4600 | 7 8 | STR/STR*IEC83-B1 STR/90° | 79 79 | Black Gray | South Africa, India |
| 250V  | 8120-1860 8120-1575 8120-2191 8120-4379 | 6 0 8 8 | STR/STR*CEE22-V1 (Systems Cabinet Use) STR/STR STR/90° 90°/90° | 59 31 59 80 | Jade Gray Jade Gray Jade Gray Jade Gray | |

* Part number shown for plug is industry identifier for plug only. Number shown for cable is Agilent Number for complete cable including plug. E = Earth Ground; L = Line; N = Neutral; STR = Straight

Installation Overview

- 1 Connect a 1, 2, 5, 10, or 13 MHz signal to the REF IN. If you are using option 001, connect as shown, see Figure 1-2 on page 1-5, with the supplied cable (OPT 001 REF OUT to REF IN).
- 2 Connect the supplied power cord to the Agilent 8922M/S and power up the instrument.

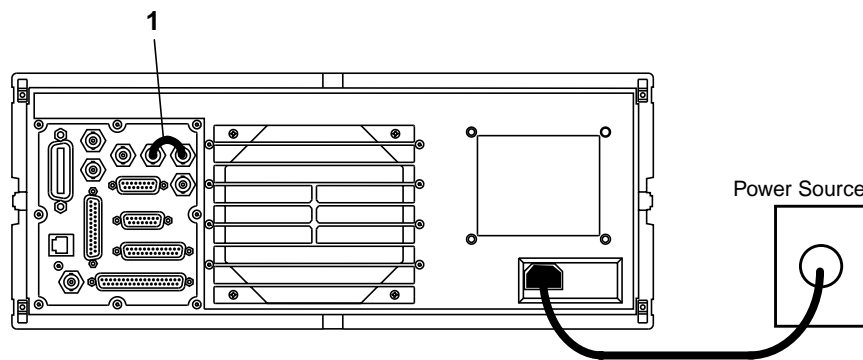

Figure 1-2

Rear View Connections

Installing Your Agilent 8922M/S Installation Overview

- 3 Access the CONFIG screen to customize the set-up of your Agilent 8922M/S. This is done by:
 - Moving to the **CONFIG** field in the bottom right-hand corner of the Cell Control screen, (the first screen that appears after power-up or after selecting **PRESET**). Rotate the cursor control knob (refer to “a”, see Figure 1-3 on page 1-6) until you are on the CONFIG field.
 - Selecting the **CONFIG** field by pushing the cursor control knob (diagram “b”, see Figure 1-3 on page 1-6).

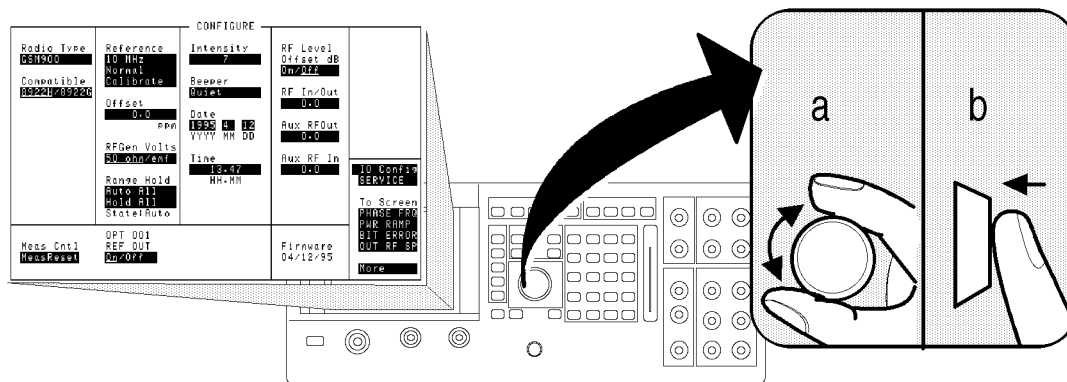

Figure 1-3 Access CONFIG Screen

- 4 To guarantee the correct operation of the Agilent 8922M/S with all mobile phones, you should use a high-stability timebase.

This step details how to configure the Agilent 8922M/S for use with either the option 001, high-stability timebase, or an external reference signal.

- A** If you have option 001 installed and wish to use this as your reference, ensure that the **OPT 001 REF OUT** field in the Configure screen is set to **On**. Access the **Reference** field in the Configure screen and select 10 MHz.
- B** If you wish to use an external reference signal, set the **Reference** field to 1, 2, 5, 10, or 13 MHz according to the frequency reference you intend to use.

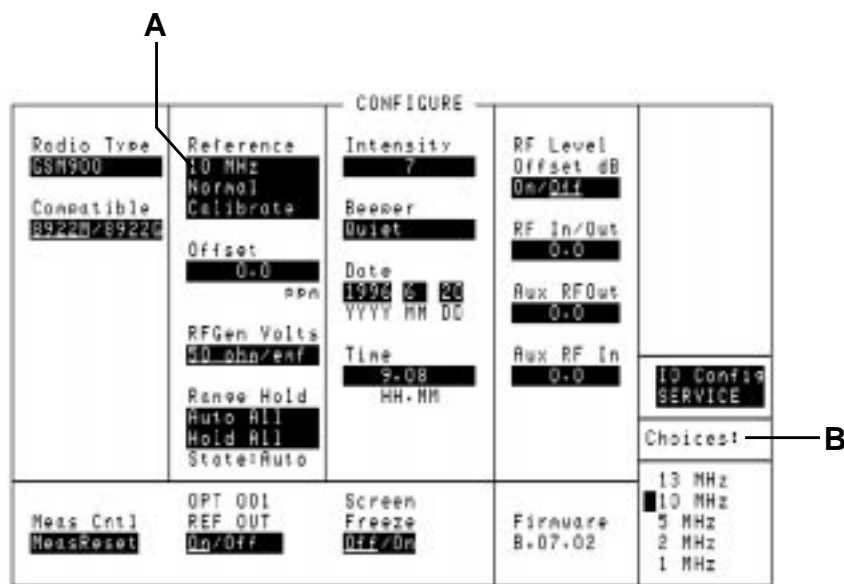

Figure 1-4 High-stability timebase set-up

To customize your Agilent 8922M/S further, refer to Chapter 4, Screens.

General Information

| | |
|--|---|
| Operation and Storage Environment | Refer to <i>General Specifications</i> in the Agilent 8922M/S Specifications section of Chapter 3, Performance Verification for information about the operation or storage environment. |
| Instrument Options | Refer to Agilent 8922M/S Specifications in Chapter 3, Performance Verification for information about instrument options. |
| Specifications | Refer to Agilent 8922M/S Specifications in Chapter 3, Performance Verification for instrument specifications. |

Making Measurements

Using This Chapter

Use this chapter to obtain an overview of how to operate the Agilent 8922M/S GSM Test Sets.

This chapter is divided into the following sections:

- Making Measurements
 - Agilent 8922M/S Operating Modes - explains how to configure the Agilent 8922M/S so that measurements can be made.
 - Measurements - details how to perform the many different measurements available on the Agilent 8922M/S.
- Advanced Features - advanced information for experienced users.

To help you understand this chapter, you may wish to consult the following sources of information:

- **Quick Start Guide** - This briefly explains the basic operating principles of the Agilent 8922M/S including making a call and simple measurements.
- **Typeface Conventions** - Found at the front matter of this manual. This explains how to interpret the different typefaces used in this manual.
- **Field Types** - Refer to Chapter 4, Screens. Explains in detail the different kinds of “fields” or areas which are displayed on the screens. Fields are mainly used for measurement results, data entry and access to other screens.
- **Screens** -Chapter 4, provides more detailed information on each of the fields contained within all of the screens available on the Agilent 8922M/S.

NOTE:

If you have the **Agilent 8922M/S Option 010 Multi-Band Test System**, refer to the appropriate *Agilent 8922 Multi-Band User’s Guide* for more information on making dual band measurements.

Agilent Technologies 8922M/S Operating Modes

This section details the procedures necessary to control the Agilent 8922M/S and GSM mobile phone in each of the main operating modes. It is recommended that you read this section before attempting the “Measurements” section.

The Agilent 8922M/S GSM Test Sets have three main modes of operation, these are:

- ACTIVE CELL
- TEST MODE
- CW GENERATOR

Active Cell

The first mode is the default mode and configures the Agilent 8922M/S as a GSM Base Station emulator. This allows calls to be made from the Agilent 8922M/S to the mobile phone and vice versa. Measurements can then be made to verify the mobile phone’s performance.

Test Mode

This mode is used when measurements need to be made on the mobile phone without a call being set up.

CW Generator

This mode configures the Agilent 8922M/S as a standard Continuous Wave (CW) Signal Generator. This is used for test applications that require an unmodulated RF carrier.

Making Measurements

Agilent Technologies 8922M/S Operating Modes

To configure the Agilent 8922M/S to the desired operating mode, carry out the following instructions, referring to Figure 2-1 on page 4 for the position of the fields.

- Ensure (1) is set to mobile phone type you require (GSM900, E-GSM, DCS1800, or PCS1900).

NOTE

For use with DCS1800 or PCS1900, refer to the HP/Agilent 83220A/E Users Guide which explains how to configure the Agilent 8922M/S to test other mobile phone formats.

- Use the knob to move the cursor to the lower field below the Operating Mode (2).
- Push the knob and select the desired Operating Mode (ACTIVE CELL, TEST MODE, or CW GENERATOR) from the menu which appears at the bottom right-hand side of the screen.

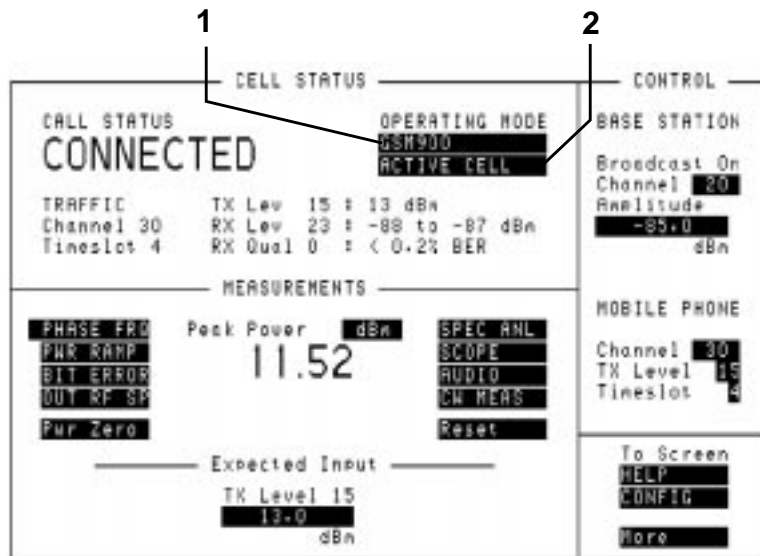

Figure 2-1

Agilent 8922M/S Operating Modes

In addition to the three main operating modes, there are three other modes available. These are:

- ACTIVE CELL+
- TEST MODE+
- CW GENERATOR+

These “+” modes have all the features of the other modes but include extra diagnostic information on the screen. This information is designed to help advanced users in fault-finding mobile phones.

ACTIVE CELL

This is the default mode after cycling the power or selecting **PRESET**. A functional mobile phone will lock on (camp on) to a signal which is produced by the Agilent 8922M/S. The characteristic of this signal appears in the **BASE STATION** fields, (1), see Figure 2-2 on page 2-6. These fields show the Channel number and the Amplitude of the signal. Once the mobile phone has camped on to the signal, it is possible to make a call between the mobile phone and the Agilent 8922M/S.

Making a Call From the Mobile Phone to the Agilent 8922M/S

- Cycle the power on the Agilent 8922M/S or select **PRESET**.
- Insert a Test SIM card into the mobile phone. [The Test SIM (Subscriber Identity Module) holds the user's customized information. Agilent supply both micro and standard Test SIMs.]
- Connect the mobile phone to the RF IN/OUT connector on the front panel of the Agilent 8922M/S.
- Switch on the mobile phone and wait for it to camp to the Agilent 8922M/S (most mobile phones display **001-01** when the mobile phone has camped).
- Dial any number on the mobile phone and press send.

The call set-up should now proceed. The **CALL STATUS** field on the screen should display **CONNECTED**, (2), see Figure 2-2 on page 2-6. Once the call has been established, the following information is displayed:

- Peak Power transmitted by the mobile phone is displayed in the center of the screen.
- In the **CELL STATUS** area, (3), see Figure 2-2 on page 2-6, the mobile phone reports its:
 - Transmit power level (TX Lev)
 - Received level (RX Lev)
 - Received signal quality (RX Qual)
- Confirmation of the Traffic Channel and Timeslot is displayed to the left of the mobile phone reports.

If the call does not proceed, there may be a problem with the mobile phone. Refer to "Test Mode" in this chapter which explains how to configure the Agilent 8922M/S to troubleshoot the mobile phone. When a call is connected, any speech received from the mobile phone is echoed back by the Agilent 8922M/S, into the mobile phone with a 0.5 second delay. This allows provisional checking of the mobile phone's audio sections by speaking into the mobile phone and listening for the echo of your voice.

Making Measurements
ACTIVE CELL

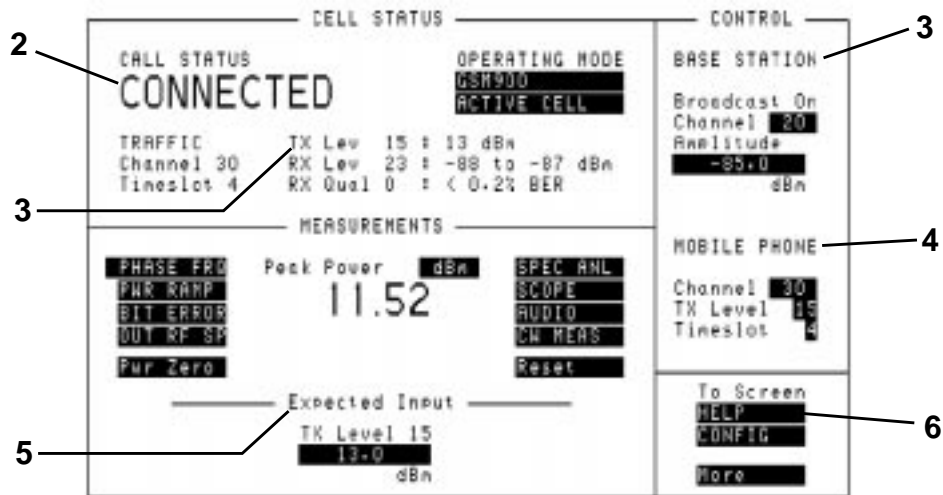

Figure 2-2 Active Cell Mode

Making a Call From the Agilent 8922M/S to the Mobile Phone

To call (or page) the mobile phone from the Agilent 8922M/S, it is necessary for the Agilent 8922M/S to know the number of the SIM in the mobile phone. [This number is the International Mobile Subscriber Identity (IMSI). This and other information is stored on the SIM card.]

NOTE

The Network number cannot be used to make a call. The Network Telephone number is allocated to the SIM and is used in a real network to page the IMSI.

There are two ways the Agilent 8922M/S can receive this information:

- Make a call from the mobile phone to the Agilent 8922M/S.

Once the call is originated from the mobile phone, the Agilent 8922M/S automatically reads the IMSI on the SIM card. If the previous call on the Agilent 8922M/S was made with the SIM card inserted in the mobile phone, and the mobile phone is camped to the Agilent 8922M/S, the mobile can be called by pressing **ORG CALL**.

- Enter the MS Information screen and enter the IMSI into the Agilent 8922M/S manually.

Press the following keys to do this:

- **SHIFT**, **CELL CONFIG** (MS INFO)
- Move the cursor to the **Paging IMSI** field and enter the IMSI using the numeric data entry keypad.
- **CELL CNTL**, **ORG CALL**

Performing a “location update” from the MS INFO screen allows the Agilent 8922M/S to update the IMSI. This can be done by either:

- changing the **Current** location parameters and waiting for the mobile phone to re-camp.
- setting **IMSI Attach/Detach** to **On** before powering on the phone. When the phone camps its IMSI is set on the MS INFO screen and a call can be made from the Agilent 8922M/S.

Changing Channel, Timeslot, and the Transmit Level

You can alter the parameters of the call before the call has been set up, or during a call. They are displayed on the right-hand side of the screen under **MOBILE PHONE**, (4), see Figure 2-2 on page 2-6. The parameters are:

- Channel
- Transmit Level (TX Level)
- Timeslot

Channel To change channel, highlight the field and enter a new channel number from the keypad. There is no interruption of communication between the Agilent 8922M/S and the mobile phone. For additional information on valid Absolute RF Channel Numbers (ARFCNs), consult the specifications in Chapter 3.

TX Level This is a coded number used by the Agilent 8922M/S to command the mobile phone to transmit at a particular power. When the TX Level is changed, two things happen:

- The mobile phone should change its transmitted power.
- The **Amplitude** field in the **Expected Input** area of the screen, (5), see Figure 2-2 on page 2-6, automatically adjusts to the nominal value defined by the **TX Level** field. This allows the RF analyzer in the Agilent 8922M/S to align itself with the mobile phone’s expected output amplitude. If the signal is not within 3 dB of the expected amplitude, it is necessary to modify the **Amplitude** field so that it is within 3 dB. Directly entering a value in the **Amplitude** field does not change the transmitted level code transmitted to the mobile phone.

Making Measurements

ACTIVE CELL

There may be many reasons for the measured level not being close to the expected level. The two most likely are that, either, the mobile phone is not operating correctly, or, there is some power loss between the Agilent 8922M/S RF IN/OUT connector and the mobile phone. If you suspect it is the second case, you can compensate the Agilent 8922M/S generator settings and measurement results for external losses or gains. The compensation is carried out in the CONFIGURE screen which is accessed using the **CONFIG** field on the bottom right-hand side of the screen, **(6)**, see Figure 2-2 on page 2-6. Refer to Chapter 4, Screens for further information.

Timeslot To change the timeslot, highlight the field and enter a new timeslot value from the keypad. The timeslots can vary from 2 to 6. (Timeslots 0, 1, and 7 are reserved for maintaining communication between the Agilent 8922M/S and the mobile phone.)

NOTE

While the Active Cell is selected, the three **MOBILE PHONE** parameters are also available on the bottom right-hand side of all measurement screens. This provides control of the mobile phone during measurements.

TEST MODE

To enter this mode, select **TEST MODE** as described in the section titled “Agilent 8922M/S Operating Modes”.

In TEST MODE, the Agilent 8922M/S no longer controls the mobile phone. The TEST MODE is used when it is not desired, or not possible, to set up a call between the Agilent 8922M/S and the mobile phone.

The **MOBILE PHONE** area available in Active Cell controls three functions simultaneously:

- The traffic channel transmitted by the Agilent 8922M/S.
- The traffic channel transmitted by the mobile phone.
- The corresponding channel used by the Agilent 8922M/S to measure the mobile phone.

In Test Mode, these functions are now separated. The traffic channel transmitted by the Agilent 8922M/S is now controlled by the **Traffic Chan** parameters, (1), see Figure 2-3 on page 2-10. The mobile phone’s transmission must be controlled manually using the mobile phone manufacturer’s service and test modes. The Agilent 8922M/S measurements are controlled by the fields below **Expected Input**, (2), see Figure 2-3 on page 2-10.

These fields are:

- Channel
- TX Level
- Burst Type

Making Measurements

TEST MODE

NOTE

While the Test Mode is selected, the three **MEASURE ON** parameters are also available on the bottom right-hand side of all measurement screens. This provides control of the Expected Input parameters during measurements.

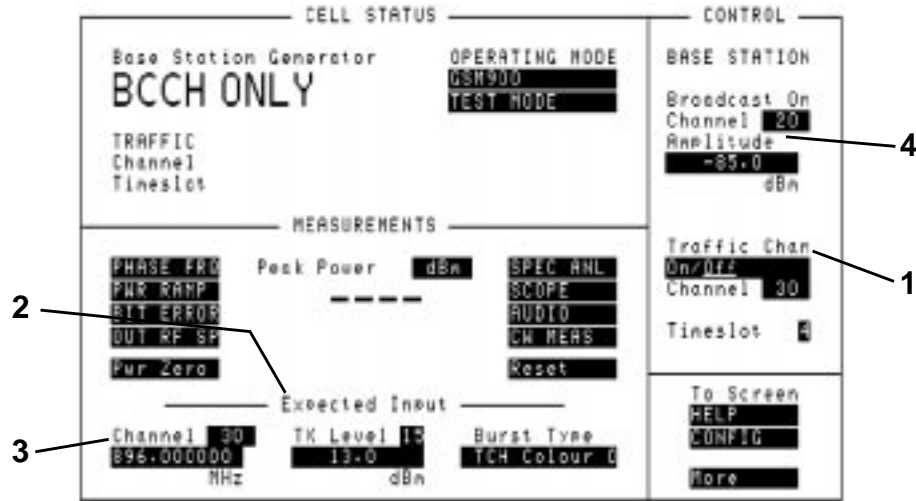

Figure 2-3 Test Mode

Mobile Phone Transmitter Testing Using Test Mode

To measure an incoming signal from the mobile phone's transmitter, perform the following steps:

- Select **TEST MODE**.
- In the **Expected Input** area, (2), see Figure 2-3 on page 2-10, enter the GSM channel number of the signal to be measured. This will automatically update the input **Frequency** field below it, (3), see Figure 2-3 on page 2-10. If a frequency needs to be measured which does not correspond to a standard GSM channel, enter the non-standard value into the **Frequency** field. This value can be anywhere from 10 MHz to 1000 MHz. A direct entry in the **Frequency** field over-rides the frequency defined by the **Channel** field above.
- Enter the expected transmit level of the mobile phone in the **TX Level** field. This will automatically update the **Amplitude** field below with the equivalent TX level represented in dBm. If a non-standard input level is expected, enter the value directly into the **Amplitude** field, this overrides the **TX Level** field above.
- Enter the expected Colour Code of the input signal. The Colour Code is a function of the central "midamble" of the transmitted burst and is needed so that measurements are correctly synchronized to the received burst. If the Colour

Code is not known, it can be determined and corrected from measurements described later. Refer to the “Advanced Features” section mentioned later in this chapter.

NOTE

In the Active Cell mode, the Colour Code is automatically set.

Once these have been selected, the Agilent 8922M/S is ready to measure incoming signals of the type specified. The mobile phone should be set up to generate a corresponding test signal to the one expected. This will require access to the mobile phone manufacturer’s servicing or test modes.

**Mobile Phone
Receiver Testing
Using Test Mode**

It is possible to analyze the mobile phone’s response to the Agilent 8922M/S Broadcast Channel (BCH), by varying the BCH number and amplitude, (4), see Figure 2-3 on page 2-10. TEST MODE provides the Agilent 8922M/S with a “forced” traffic channel (TCH) generator which can be turned on and off without the need for any signaling or the presence of a mobile phone. A forced TCH can be generated on any channel in the GSM Base Station range and is enabled by the **On/Off** toggle field (1) below the Traffic Chan or the **ORG CALL** and **END CALL** keys.

The presence of both the BCH and forced TCH signals from the Agilent 8922M/S allows the mobile phone’s receiver to be stimulated with signals identical to those used on a real call. These signals can be used in conjunction with the mobile phone manufacturer’s service and test modes to help measure and troubleshoot the mobile phone. With these features, it is possible to make bit error rate measurements and test the mobile phone’s receiver sensitivity when there is no call set up.

CW GENERATOR

To enter this mode, select **CW GENERATOR** as described in the section titled “Agilent 8922M/S Operating Modes”. The CW Generator mode has the same measurement capabilities as the Test Mode but replaces the GSM BCH and forced TCH signals with a single unmodulated RF carrier. The frequency and amplitude of the Continuous Wave (CW) signal is controlled by the **Channel**, **Amplitude**, and the **Frequency** fields (1). When a GSM channel number is entered in the Channel field, this automatically updates the generator **Frequency** field below it. If it is necessary to generate a non GSM channel frequency, enter a value directly into the frequency field. This range varies from 10 MHz through 1000 MHz. A direct frequency entry over-rides the **Channel** field above. The unmodulated RF signal can be used for any general purpose application and can be particularly useful for checking some aspects of the mobile phone’s receiver where a CW signal is needed.

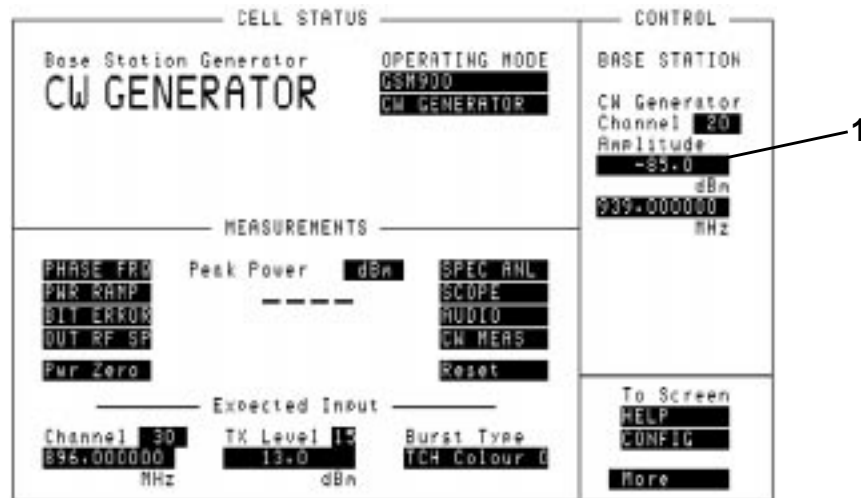

Figure 2-4

CW Generator

Measurements

The measurements available on the Agilent 8922M/S can all be accessed from the cell control screen by selecting a measurement field under **MEASUREMENTS**, (see Figure 2-5 on page 2-13) and pushing the knob.

GSM Specific Measurements

The measurements available are:

- Peak Carrier Power
- Phase and Frequency Error
- Power Ramp Mask
- Bit Error Rate
- Output RF Spectrum (modulation or ramping, Option 006 only)

Ancillary Measurements

You can also use the *toolkit* capabilities of the Agilent 8922M/S. These additional measurements are:

- Spectrum Analyzer (Option 006 only)
- Scope
- Audio Measurements
- CW Measurements

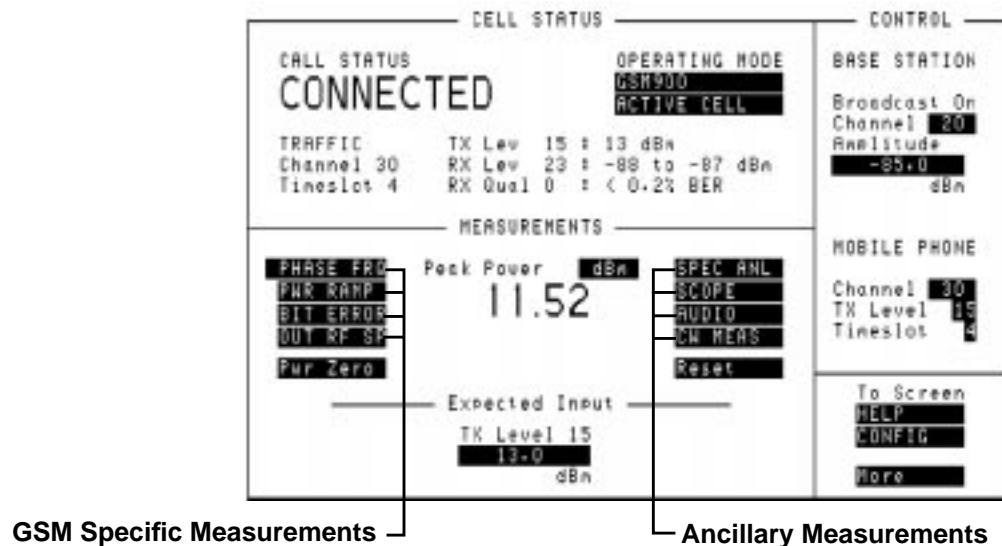

Figure 2-5

Agilent 8922M/S Measurements

Making Measurements Measurements

After making one type of measurement, another can be made by simply pressing **CELL CNTL** and, using the knob, selecting the next measurement of your choice.

Peak Carrier Power Measurement

The peak transmitter carrier power averages the transmitter carrier power for a single burst. This average is calculated over the time that the data information bits are transmitted.

NOTE

Select the **Pwr Zero** field, disconnect external source and lower BCH power, (3), see Figure 2-6 on page 2-14, to zero the power meter before any signal is applied.

Method

The peak transmitter carrier power value is displayed on the cell control screen. After you have set up a call (**Active Cell**) or manually aligned the Agilent 8922M/S to the mobile phone (**Test Mode/CW Generator**), the Peak Power reading is displayed in the center of the screen (1).

Below the CALL STATUS area of the cell control screen are reports from the mobile phone. These appear only when using Active Cell. They indicate the TX Level which the phone is transmitting and the RX Level and RX Quality of the received signal, (2), see Figure 2-6 on page 2-14.

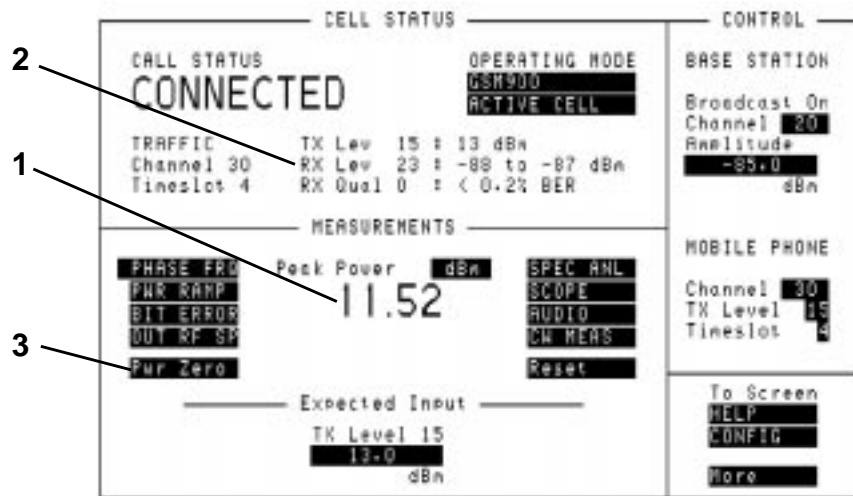

Figure 2-6

Peak Power Measurements

Phase and Frequency Error Measurement

Phase error and frequency error are measures of the modulation and noise performance of the radio's transmitter path.

Method

Select the **PHASE FRQ** field on the cell control screen to access the phase and frequency measurements.

NOTE

The test is run automatically when the screen is selected.

The measurement fields in this screen are RMS Phase Error, Peak Phase Error and Frequency Error (1), see Figure 2-7 on page 2-15.

The Agilent 8922M/S input sensitivity (2) can be varied, if necessary, to ensure that the input signal level matches the Agilent 8922M/S RF Analyzer. Valid measurements are only made when the signal is within 3 dB of the RF Analyzer setting.

The Agilent 8922M has the option of using multi-burst measurements (4). This gives the ability to make several phase and frequency measurements using more than one burst. For more information refer to Chapter 4, Screens, Phase and Frequency Error screen.

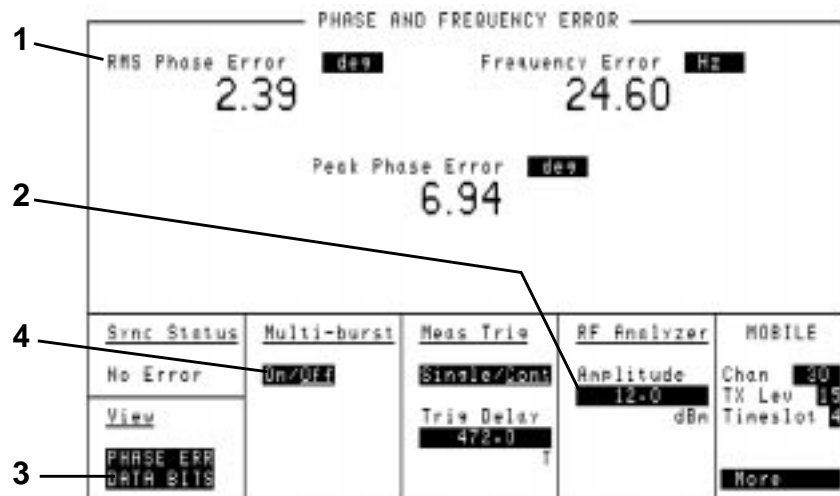

Figure 2-7

Phase and Frequency Error Measurements

Two additional screens in the phase and frequency measurement section can be revealed if you select (3).

Making Measurements Measurements

These are:

- **PHASE ERR** - this displays the phase error graphically. The phase error trace is displayed using an autoscaling phase error axis versus data bits (numbered 0 through 147).
- **DATA BITS** - this screen allows you display a screen which details the values of the 148 bits in the timeslot (including midamble). If a known test signal is being used, the reception of these bits can be verified.

Power Ramp Mask Measurements

To avoid unwanted interference and to ensure successful reception at the Base Station, the mobile phone's transmitted signal must conform to GSM standards. The purpose of the power ramp is to display the pulsed signal and verify that it conforms to these standards.

Method

Selecting **PWR RAMP** on the cell control screen gives you access to the power ramp measurement screens.

The marker (1), see Figure 2-8 on page 2-16 can be used to make a measurement at a discrete point in time along the signal trace. The amplitude at this point is displayed in the top left-hand corner of the screen.

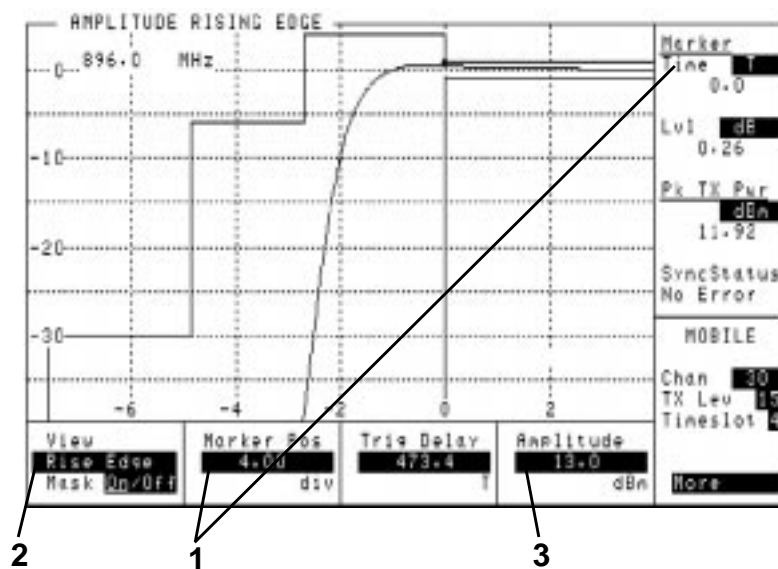

Figure 2-8

Power Ramp Measurements

The power ramp measurements are divided into three screens where you can view different parts of the signal and one screen which displays a series of amplitude values at various times during the burst. These screens can be revealed by highlighting and selecting from the **View** field (2):

- **Rise Edge** - displays the top 30 dB of the rising section of the waveform.
- **Top 2 dB** - displays the signal during the middle part of the burst allowing analysis of the ripple of the signal.
- **Fall Edge** - displays the signal during the falling edge of the burst allowing analysis of the fall time of the signal.
- **Summary** - details the amplitude measurements made at the times selected in the 12 time fields. You can choose your own time-positions, or use the default settings.

The sensitivity of the Agilent 8922M/S receiver can be varied (3) allowing you to verify whether the input signal level matches the Agilent 8922M/S RF Analyzer. Valid measurements are only made when the signal is within 3 dB of the RF Analyzer setting.

Measurement Summary

The Measurement Summary field on the DSP Analyzer Ampl Main screen displays whether HI/LO limits set for the measurement display fields, (Ampl1-12, pk+ flatness, or pk- flatness) were exceeded in the last measurement. The possible Measurement Summary displays are:

Failed

One or more measurement limit was exceeded.

Passed

No measurement limits were exceeded.

No measurement limits are set, or, all of the Ampl and Pk measurement displays are turned off.

A blank field

The blank field is displayed when the measurement is armed. It will remain blank until the measurement is complete.

Refer to "Pulse Measurements" within this section for a description of Pulse Measurements. These measurements are available with option 006 only.

Making Measurements Measurements

Pulse Measurements (Available if Option 006, Spectrum Analyzer, is Fitted)

If you have option 006 (spectrum analyzer) installed, you can make measurements on the lower portion of the pulse. These measurements can be accessed from the Power Ramp screens.

- The main measurements, Pulse On/Off Rise and Pulse On/Off Fall are displayed at the top of the screen (1), see Figure 2-9 on page 2-18
- The sensitivity of the Agilent 8922M/S receiver can be varied (2) allowing you to verify whether the signal still falls within the boundaries of the GSM power mask.

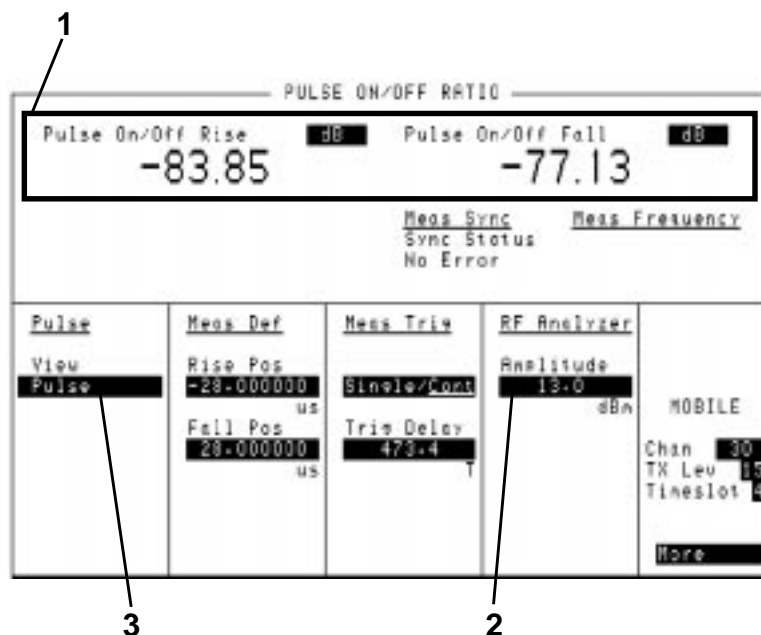

Figure 2-9

Pulse Measurements

The Agilent 8922M/S provides three pulse measurements which can be selected using **View** (3). These are:

- **Pulse** - pulse on/off ratio measures the ratio of the average transmitter- power (pulse on) to a specified time-position when power is reduced (pulse off). The default settings are 28 μ s before bit 0 and 28 μ S after bit 147.
- **Puls Rise** - this screen displays the signal during the initial rise of the pulse.
- **Puls Fall** - this screen displays the signal during the final fall of the pulse.

Bit Error Rate Measurement

The Bit Error Rate measurement allows you to test the sensitivity of the mobile phone's receiver. By reducing the signal transmitted by the Agilent 8922M/S, you can test the ability of the receiver to accurately decode its incoming signal. Data bits that are decoded are sent back to the Agilent 8922M/S. The Agilent 8922M/S compares them to original signal that was sent out and the differences are derived from this. The audio echo function that works in the Cell Control screen is turned off when making a BER measurement.

Method

To run a bit error rate test, select the **BIT ERROR** field in the cell control screen. This reveals the bit error measurement screen.

This test will run automatically if you set the **Single/Cont** field to CONT. To run a test set the **Run/Stop** field to RUN. This toggle field start/stops the BER test (1) ratio, see Figure 2-10 on page 2-19.

NOTE

There are two sets of results displayed.

- Intermediate Results - this is a running total of the bit errors as the bits are being tested (2), (this is useful where a large number of bits are being tested).
- Final Results - this shows the completed BER (3). This is displayed after all the bits have been tested.

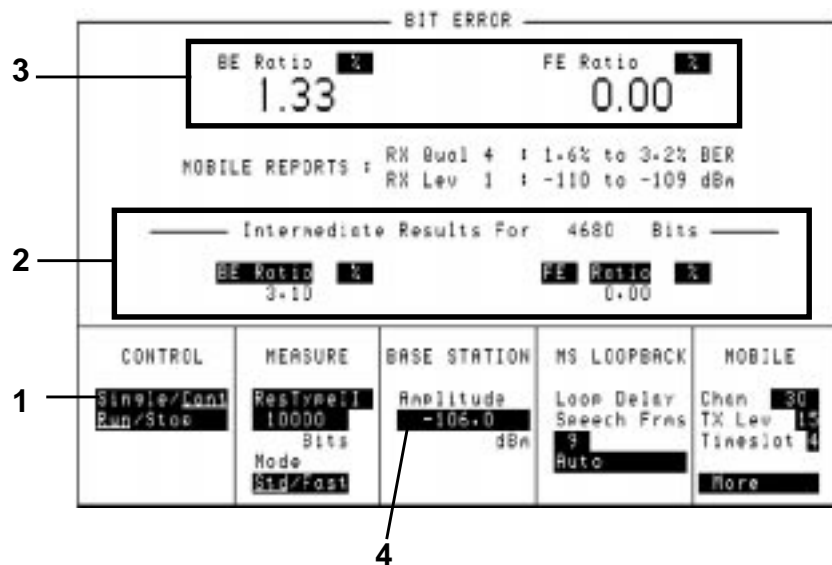

Figure 2-10

Bit Error Rate Measurement

Making Measurements

Measurements

By varying the Base station **Amplitude** field (4), you can test the mobile phone's receiver sensitivity. Actual results can be compared with the values reported by the radio.

NOTE

If the Base Station amplitude is lowered too much, the radio will lose the call. This will need to be re-established by increasing the base station amplitude, returning to the cell control screen, and originating the call before you can continue measurements.

NOTE

Not all phone types support burst-by-burst BER measurements.

Output RF Spectrum Measurements
(Available if Option 006, Spectrum Analyzer, is Fitted)

The Output RF spectrum measurement shows the spectral power (due to the effects of ramping or modulation) at a specified frequency offset. These are relative measurements that compare the result at the offset frequency with the value at the center frequency. You can also view the output RF spectrum trace from this screen.

Method

Select **OUT RF SP** in the cell control screen.

To make a measurement, do the following:

- Ensure the **Freq Offset** is set to zero (1), see Figure 2-11 on page 2-21.
- Select **Ramp Ref** or **Mod Ref** (2) (depending on whether you want to make a ramping measurement or a modulation measurement).

This sets the reference level to which the offset frequency values are compared.

- Select **Ramping** or **Modulation** (3).
- Set your **Freq Offset** value (4).

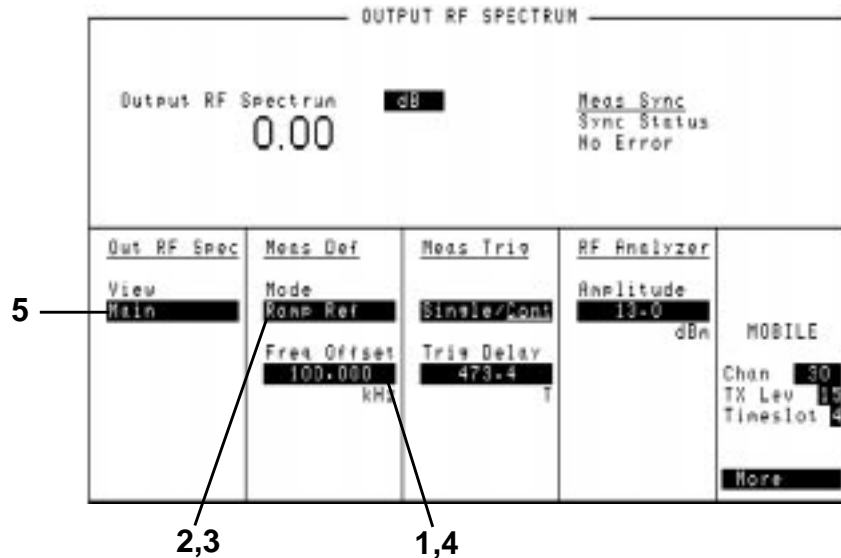

Figure 2-11 Output RF Spectrum Measurements

- The trace of the output RF spectrum can be viewed if you highlight **View** and select **Trace** (5).

Output RF Spectrum Measurements Using a 3-Pole Synchronously Tuned Measurement Filter

GSM Recommendation 11.10 and 11.20 set the requirements for the out-of-channel performance of base station and mobile station transmitters with the Output RF Spectrum specification. The specification calls for the measurement of transmitted energy at several offsets from the carrier frequency. Two types of measurements are required:

- Check the interference due to modulation.
- Check the interference due to ramping of the signal amplitude (switching transients).

Limits are specified for each type of measurement at specified frequency offsets. The GSM specified limits are based on a 5-pole synchronously tuned measurement filter.

Making Measurements
Measurements

In the Agilent 8922, Output RF Spectrum measurements are made using a 3-pole synchronously tuned measurement filter. The measurement results will differ from measurements using a 5-pole filter.

The difference between measurements of the “ideal” signals using a 3-pole filter and a 5-pole filter are shown in Table 1 and Table 2. These values are added to the GSM specifications to obtain equivalent limits for Output RF Spectrum measurements using 3-pole synchronously tuned measurement filter. The adjusted Output RF Spectrum limits are based on a 3-pole filter are shown in Table 3 and Table 4.

Table 1 **3-Pole Specification Difference Output RF Spectrum due to Modulation**

| | Offset from Carrier (kHz) | | | | |
|-----------------|---------------------------|-----|-----|-----|-------------|
| | 100 | 200 | 250 | 400 | 600 to 1800 |
| Difference (dB) | 0 | 2.5 | 1.0 | 9.0 | 0 |

Table 2 **3-Pole Specification Difference Output RF Spectrum due to Switching**

| | Offset from Carrier (kHz) | | | |
|-----------------|---------------------------|-----|------|------|
| | 400 | 600 | 1200 | 1800 |
| Difference (dB) | 6 | 4 | 2 | 0 |

NOTE It is important to note that these values are estimates based on simulation and measurements. They are intended to allow the user to estimate their transmitters conformance to GSM Output RF Spectrum requirements.

Table 3 Adjusted Limits Based on 3-Pole Filter Output RF Spectrum Due to Modulation

| Power Control Level | Offset from Carrier (kHz) | | | | | |
|---------------------|---------------------------|--------|----------|--------|--------|-------------|
| | 0 | 100 | 200 | 250 | 400 | 600 to 1800 |
| 0 (43 dBm) | 0 dB | 0.5 dB | -27.5 dB | -32 dB | -51 dB | -70 dB |
| 0 (39 dBm) | 0 | 0.5 | -27.5 | -32 | -51 | -66 |
| 0 (37 dBm) | 0 | 0.5 | -27.5 | -32 | -51 | -64 |
| ≥ 5 (≤ 33 dBm) | 0 | 0.5 | -27.5 | -32 | -51 | -60 |

Table 4 Adjusted Limits Based on 3-Pole Filter Output RF Spectrum Due to Switching

| Power Level (dBm) | Offset from Carrier (kHz) | | | |
|-------------------|---------------------------|--------|--------|--------|
| | 400 | 600 | 1200 | 1800 |
| 43 | -3 dB | -17 dB | -19 dB | -24 dB |
| 41 | -5 | -17 | -19 | -24 |
| 39 | -7 | -17 | -19 | -24 |
| 37 | -9 | -17 | -19 | -24 |
| 35 | -11 | -17 | -19 | -24 |
| 33 | -13 | -17 | -19 | -24 |
| 31 | -15 | -19 | -21 | -26 |
| 29 | -17 | -21 | -23 | -28 |
| 27 | -17 | -22 | -25 | -30 |
| 25 | -17 | -22 | -27 | -32 |
| 23 | -17 | -22 | -29 | -34 |
| ≤ 21 | -17 | -22 | -30 | -36 |

Making Measurements

Measurements

Spectrum Analyzer (Available if Option 006, Spectrum Analyzer, is Fitted)

The spectrum analyzer allows you to view the mobile phone's signal over a wide dynamic range. It also allows you to view any adjacent interference which may exist.

NOTE

The spectrum analyzer can detect very low power signals where **Active Cell** and even **Test Mode** cannot operate. Broken cable or connectors can be found using this function.

Method

Select **SPEC ANL** in the cell control screen.

Selecting **(1)** provides access to other functions of the spectrum analyzer. These are:

- **Main** - the default screen has basic spectrum analyzer functions, see Figure 2-12 on page 2-25.
- **RF Gen** - this controls the RF generator in the Agilent 8922M/S. The generator signal can be fed back into the spectrum analyzer for signal confirmation. The Aux RF OUT port should be connected to the RF In/Out, and the RF Output set to "Aux RF OUT".

NOTE

If both the input and output are set to **RF IN/OUT**, large errors in measured signal level will be seen.

- **Marker** - this screen allows you to control the marker for the input signal.
- **Auxiliary** - the auxiliary screen controls the inputs and the attenuator settings.

NOTE

The RF Generator and spectrum analyzer can be tuned to different frequencies allowing the inspection of the IF signals inside the mobile phone.

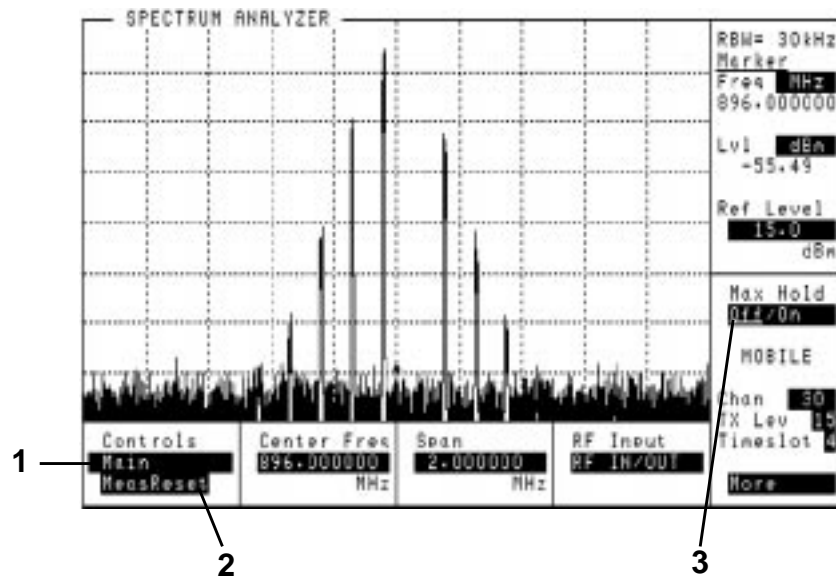

Figure 2-12 Spectrum Analyzer Measurement

Use the **MeasReset** (2) to reset the trace and measurements in the Agilent 8922M/S. This is useful if you are using the **Max Hold** field (3).

The resolution bandwidth of the spectrum analyzer is automatically coupled to the frequency span. Reducing the span to less than 200 kHz can be useful when checking the mobile phone's transmitter.

Making Measurements Measurements

Scope

The oscilloscope function of the Agilent 8922M/S allows you to view the demodulated signal from the mobile phone. This can be used for fault-finding in the audio path.

Select **SCOPE** in the cell control screen to gain access to the oscilloscope function of the Agilent 8922M/S.

Selecting **(1)**, see Figure 2-13 on page 2-26, gives access to other functions of the oscilloscope. These are:

- **Main** - gives you the basic oscilloscope functions for viewing and measuring the trace.
- **Trigger** - allows you to trigger the input signal from a variety of sources.
- **Marker** - offers you the capability to measure the voltage at discrete points in time along the trace. The result is shown in the top right-hand corner of the screen. You may find it helpful to use the **(SHIFT)**, **(PREV)**, **(HOLD)** feature when using the marker.

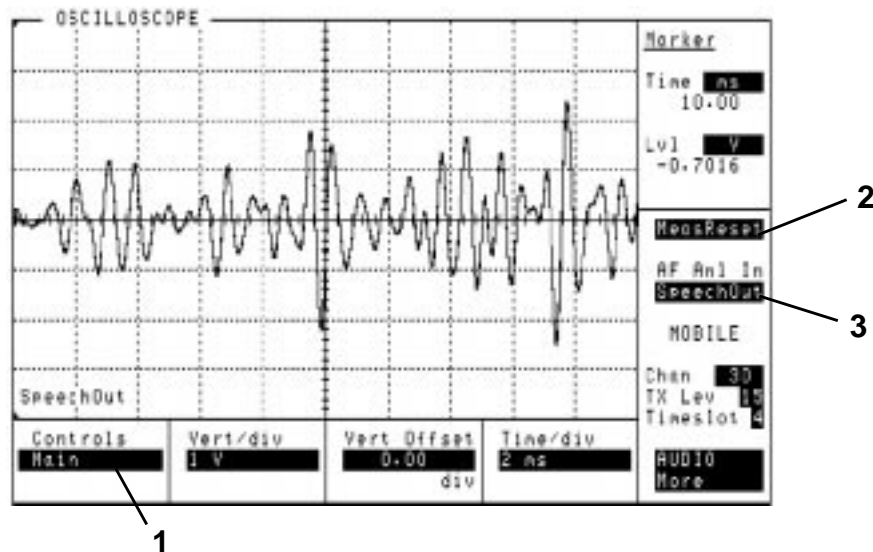

Figure 2-13

Oscilloscope Measurements

Use the **MeasReset** (2) to reset the trace and measurements in the Agilent 8922M/S. This is useful for single triggered measurements.

Set **AF An1 In** (3) to change the source of the signal being directed to the Audio Analyzer Input. Refer to Screens, Chapter 4 for further information.

Audio

The audio function measures the audio frequency and voltage of the demodulated signal from the mobile phone or from a number of other sources selectable using **AF An1 In (5)**, see Figure 2-14 on page 2-27.

Select **AUDIO** in the cell control screen to gain access to the audio function of the Agilent 8922M/S.

The measurements of the audio voltage and frequency commence within a short time of the screen being accessed.

The ac voltage (1) and the audio frequency (2) are the two main measurements made in this screen. Additional measurements, such as DC Level, can be made by selecting the **AF Freq** field. (2). The audio frequency generator (3) is used to generate an audio signal from dc up to 25 kHz. The AF analyzer fields sets the conditions for measuring the audio signal (4).

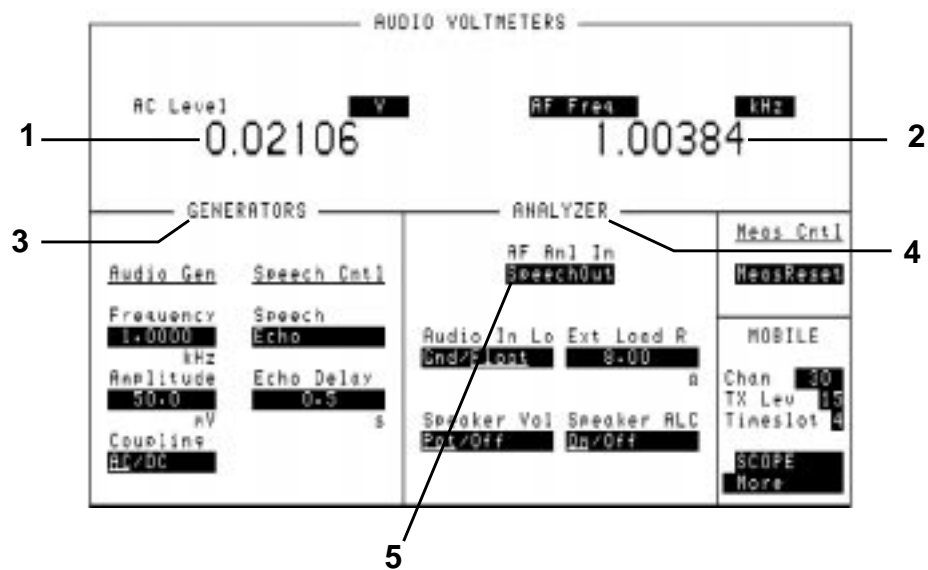

Figure 2-14

Audio Measurements

Making Measurements Measurements

CW Measurement

The CW Measurement screen displays the carrier frequency and power of a continuous (non-pulsed) signal. The CW Power measurement offers a greater dynamic range than is available when making pulsed measurements.

CW Power is a broadband measurement. The CW Frequency measurement is obtained using a tuned, selective input. The RF analyzer should be set to within 500 kHz of the expected signal frequency.

In the GSM band, the value that is entered should be set to the nearest 100 kHz. Select **CW MEAS** in the cell control screen to gain access to the power measurements of the Agilent 8922M/S.

The CW measurements are made automatically when you access the screen.

The CW Frequency field (1), see Figure 2-15 on page 2-28, displays the carrier frequency of the signal and CW Power (2) shows the power of the carrier signal. It is also possible to display the difference between the measured frequency and the value selected by choosing **CWFreqErr** from field 1.

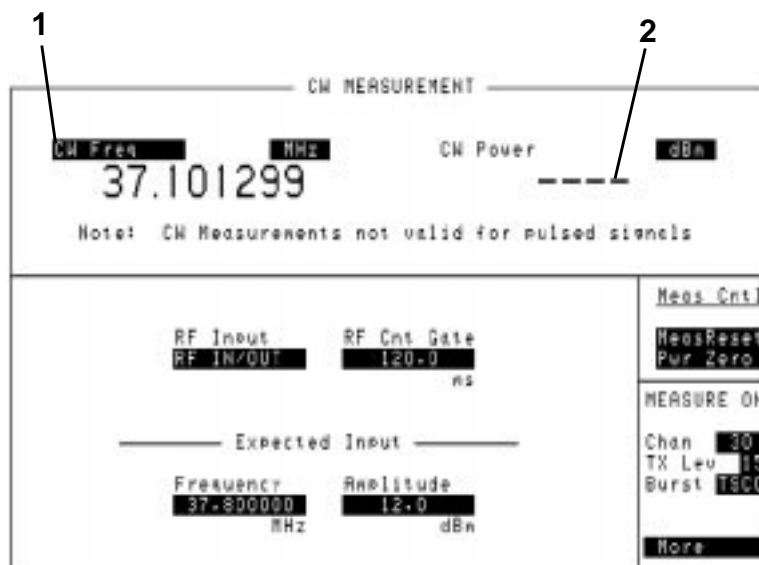

Figure 2-15

CW Measurements

These measurements can be reset using **MeasReset**. Select **Pwr Zero** before power is applied to zero the power meter in the Agilent 8922M/S.

NOTE

Although CW Measurements is a broadband measurement, it uses calibration data that relies on the expected input frequency being set correctly. The Power Detector is connected so that it will only make measurements on signals present at the RF In/Out port.

If You Have Problems with a Measurement

This section tells you what to do if either of the following screen display events occurs:

- Message Line Messages (on the top of the screen).
 - Is a Message Line displayed at the top of the screen.
 - Possible Solutions to Message Line Errors.
- Sync Status Messages
 - Is an Error Message Displayed in the Sync Status Field.

Refer to Chapter 7, “Messages”, for more information.

Is a Message Line displayed at the top of the screen?

At position 1, see Figure 2-16 on page 2-31, a message line appears if:

- Attempt To Arm or Query an Inactive Measurement - check that a measurement has been selected from the To Screen.
- Trigger too late, decrease trigger delay - See Trigger Timing B
- Trigger too early, increase trigger delay - See Trigger Timing B
- Measurement Armed, awaiting trigger - See Trigger Timing A

Making Measurements
If You Have Problems with a Measurement

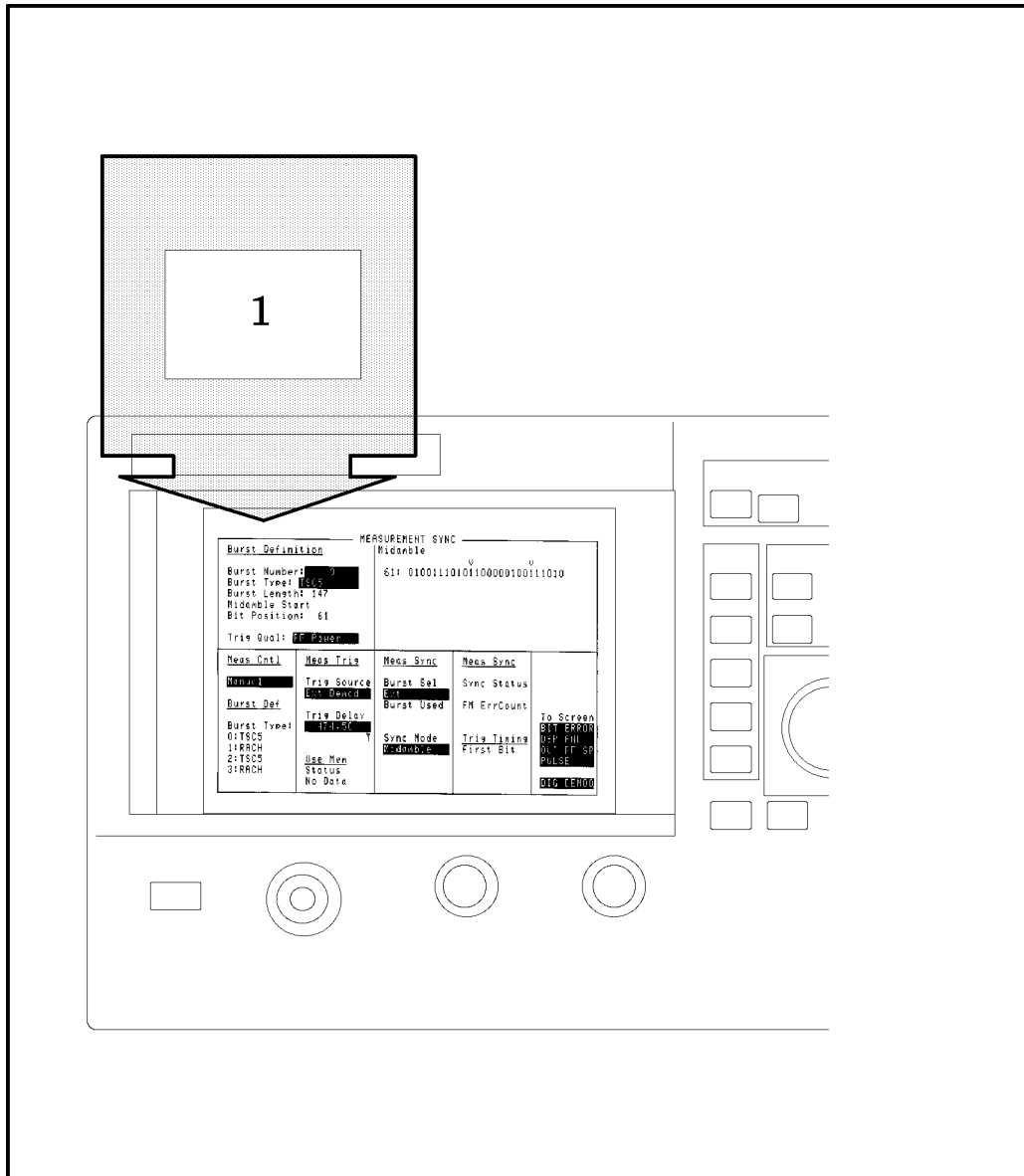

Figure 2-16

Making Measurements

If You Have Problems with a Measurement

Possible Solutions to Message Line Errors

The signal processing hardware that is used to generate measurement results has to be told when to take data samples. If the trigger to do this is misaligned with the signal, there may be errors in the results that are displayed.

Trigger Timing A

Check if the trigger is being received.

On the MEAS SYNC screen (press **MEAS SYNC** to gain access), check if the correct burst type has been defined.

Trigger Timing B

Check if the trigger is being received at the correct time.

The First Bit field (**A**), see Figure 2-17 on page 2-32, on the Phase Freq: Data Bits screen displays the time difference between when a trigger is being received and when the first bit of a burst occurred. The time difference is only valid if FMErrCount is 0. The timing difference can be corrected by altering the trigger delay (B).

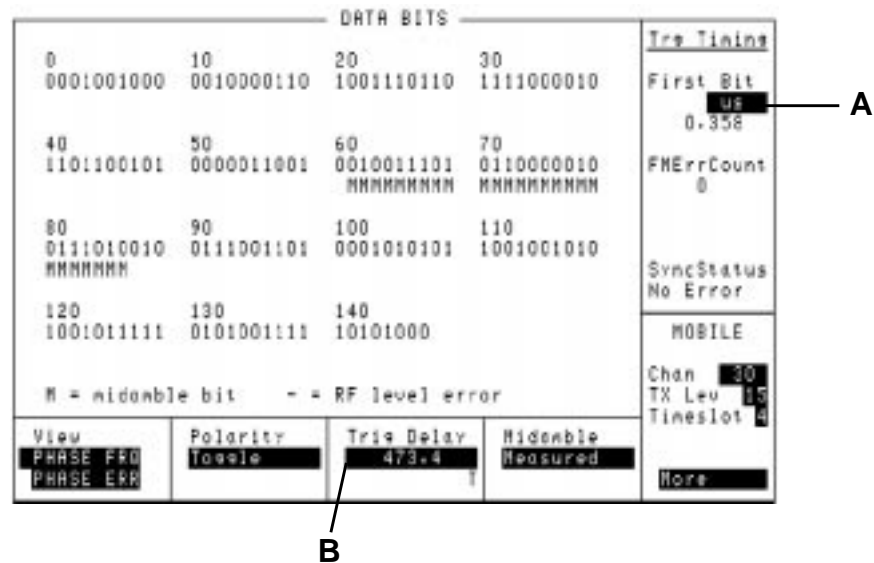
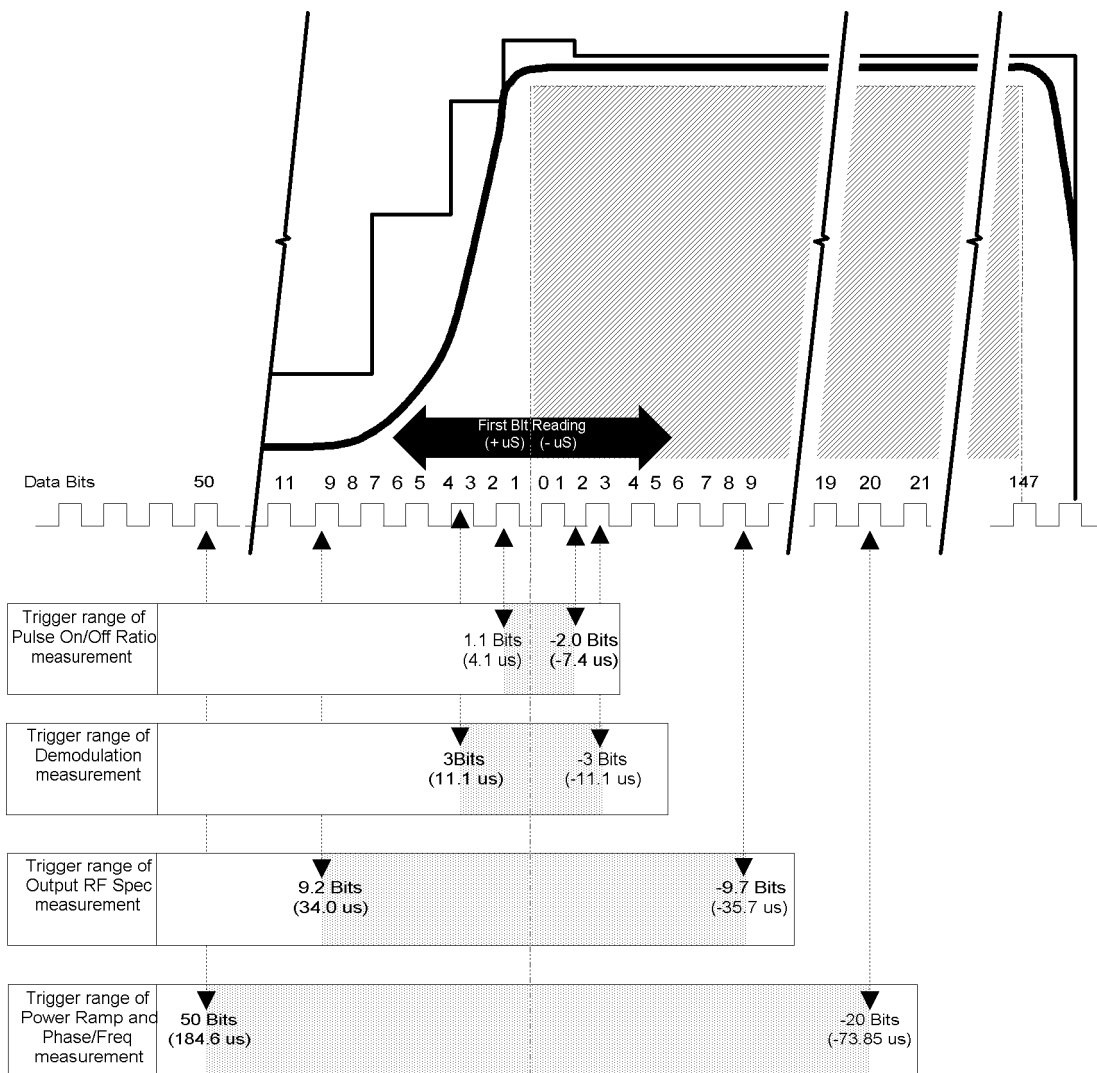

Figure 2-17

Trigger Range For Pulsed RF



Making Measurements

If You Have Problems with a Measurement

Is an Error Message Displayed in the Sync Status field?

The sync status field displays an error message for the following errors:

- Bad Sync - demodulation error, perform a Phase/Frequency error measurement to identify which of the Sync Status error listed below may be the possible problem.
- FM Errors - see solutions 1, 2, 3, 4
- Short Burst - see solutions 1, 4
- Level Late - see solutions 1, 2, 3, 4
- Level Short - see solutions 1, 2, 3, 4
- Low Level- see solution 3
- RF Ovrload - see solution 3

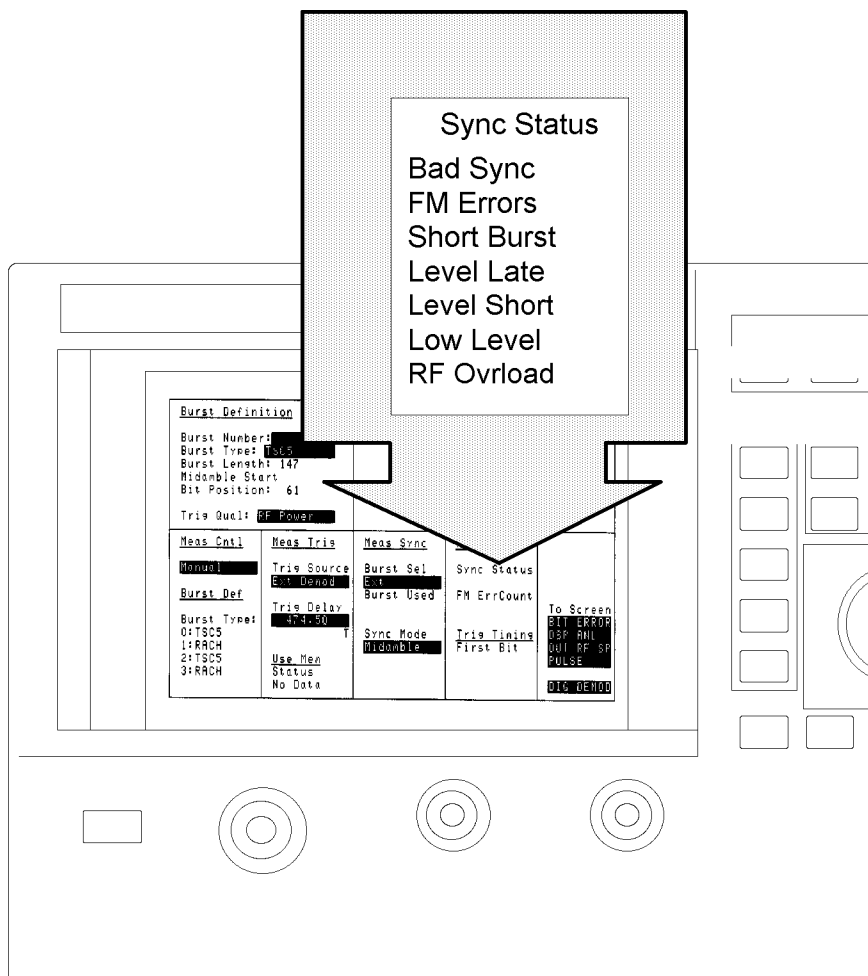

Possible Solutions to Sync Status Errors **Solution 1 - Trigger Timing**

Check if the trigger is being received.
On the MEAS SYNC screen (press **MEAS SYNC** to gain access), check if the correct burst type has been defined. On the Data Bits screen:

- A** The First Bit field on the Phase Freq:Data Bits screen displays the time difference between when a trigger is being received and when the first bit of a burst occurred (**A**). The time difference is only valid if FMErrCount is 0.
- B** Check the delay in the Trig Delay field (**B**).

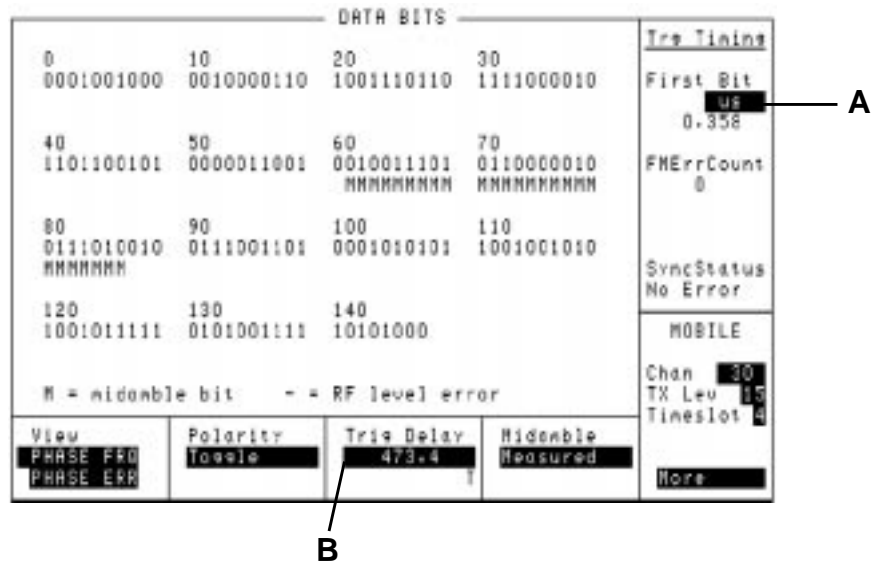

Figure 2-18

Making Measurements

If You Have Problems with a Measurement

Solution 2 - Midamble Sync

- On the MEAS SYNC screen (press **MEAS SYNC** to gain access),
- Check the definition of the signal's burst type (**A**).
 - Check the Burst Sel field (**B**).

| Burst Definition | | MEASUREMENT SYNC | | |
|---------------------|-------------|-------------------------------|-------------|-----------|
| Burst Numbers: 0 | | Midamble | | |
| Burst Type: TSC5 | | 61: 0100111010110000010011010 | | |
| Burst Length: 147 | | | | |
| Midamble Start | | | | |
| Bit Positions: 61 | | | | |
| Trix Qual: RF Power | | | | |
| Burst Def | Meas Trix | Meas Sync | Meas Sync | Use Men |
| Burst Type: | Single/Cont | Burst Sel | Sync Status | Trix Src |
| 0:TSC5 | | Ext | Status | Mid Sync |
| 1:RACH | Trix Source | Burst Used | FN ErrCount | Status |
| 2:TSC5 | Ext Denod | | | Old Data |
| 3:RACH | Trix Delay | | | |
| | 465.0 | | | |
| Denod Arn | Hopped TCH | Sync Mode | Trix Timing | To Screen |
| Bray/Dizora | ARFCN Cntl | Midamble | First Bit | PHASE FRQ |
| | Auto | | | PWR RAMP |
| | ARFCN | | | BIT ERROR |
| | | | | OUT RF SP |
| | | | | None |

Check the bit pattern of your measurement

Perform a Data Bits measurement (**D**). An “M” will display under the bits that are identified as the midamble bits.

| DATA BITS | | | | Trix Timing |
|-------------------------------------|------------|------------|------------|-------------|
| 0 | 10 | 20 | 30 | First Bit |
| 0001001000 | 0010000110 | 1001110110 | 1111000010 | us |
| | | | | 0.358 |
| 40 | 50 | 60 | 70 | FN ErrCount |
| 1101100101 | 0000011001 | 0010011101 | 0110000010 | 0 |
| | | MMMMMMMM | MMMMMMMM | |
| 80 | 90 | 100 | 110 | SyncStatus |
| 0111010010 | 0111001101 | 0001010101 | 1001001010 | No Error |
| MMMMMM | | | | |
| 120 | 130 | 140 | | MOBILE |
| 1001011111 | 0101001111 | 10101000 | | Chan 30 |
| | | | | TX Lev 15 |
| | | | | Timeslot 4 |
| M = midamble bit - = RF level error | | | | |
| View | Polarity | Trix Delay | Midamble | |
| PHASE FRQ | Toeole | 473.4 | Measured | None |
| PHASE ERR | | | | |

Solution 3 - Level

Check the following fields on the RF Generator/RF Analyzer screen (press **SHIFT**, **CELL CNTL**, (RFG/RFA) to gain access).

- 3 Pulse field **(a)**, (if signal is pulsed) Ext or Hop Trig should be selected.
- 4 Amplitude field **(b)**, for the expected amplitude
- 5 Frequency field **(c)**, for the correct frequency.
- 6 RF Input field **(d)**, for the correct connector choice.
- 7 AGC Mode field **(e)**. If either Open or Auto is the selected mode, check the value in the Open Loop DAC **(f)** Value field. If Closed is the selected mode, check that the burst is repetitive (at least one timeslot every two frames).

Check the actual amplitude of the input signal.
Perform a Peak Carrier Power measurement.

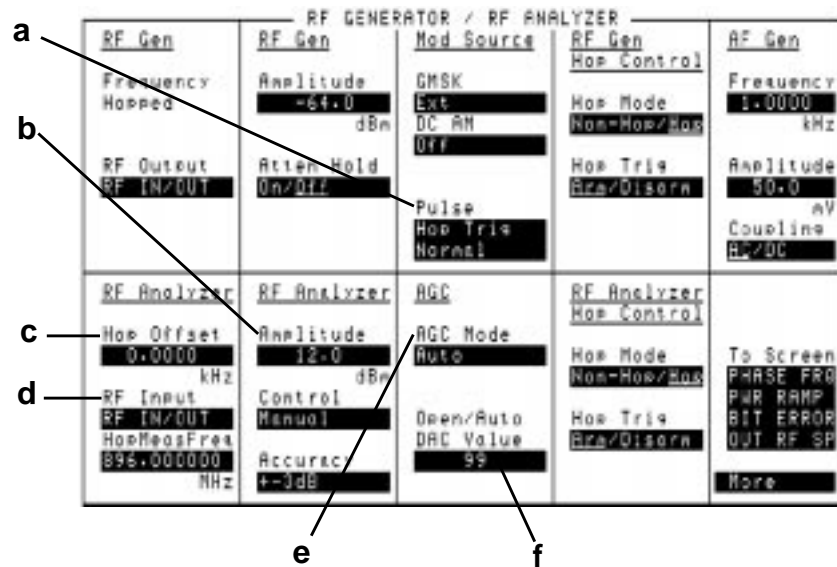

Making Measurements

If You Have Problems with a Measurement

Solution 4 - Amplitude Envelope

- Check if the Pulse Amplitude is ± 1 dB of the expected value during the useful part of the burst.

If FM Errors:

Perform a Phase Freq:Data Bits measurement. Dashes (a) will display under the bits where the power is too low.

If No FM Errors:

Perform pulse demodulation measurements. Connect PULSE (DEMODULATION OUT) connector to SCOPE IN (MEASURE) connector on the front panel.

| DATA BITS | | | | Trg Timing |
|--|------------|------------|------------|------------|
| 0 | 10 | 20 | 30 | First Bit |
| 0001001000 | 0010000110 | 1001110110 | 1111000010 | 0.358 |
| 40 | 50 | 60 | 70 | FMErrCount |
| 1101100101 | 0000011001 | 0010011101 | 0110000010 | 0 |
| | | MMMMMMMM | MMMMMMMM | |
| 80 | 90 | 100 | 110 | SyncStatus |
| 0111010010 | 0111001101 | 0001010101 | 1001001010 | No Error |
| MMMMMM | | | | |
| 120 | 130 | 140 | | MOBILE |
| 1001011111 | 0101001111 | 10101000 | | Chan 30 |
| | | | | TX Lev 15 |
| | | | | Timeslot 4 |
| M = midamble bit - = RF level error | | | | |
| View | Polarity | Trig Delay | Midamble | |
| PHASE FRD | Toggle | 473.4 | Measured | |
| PHASE ERR | | T | | None |

Advanced Features

Other Screens

The screens mentioned in this section are not necessary for simple measurement of mobile phones as the work is done by the functions mentioned previously. However, the advanced user may find it worthwhile to know what these screens are and what they are capable of doing.

- **RF Generator/RF Analyzer** - this screen controls the Agilent 8922M/S RF generator and RF analyzer. This screen can be accessed by pressing the following keys:
 - **SHIFT**, **CELL CNTL**, (RFG/RFA)
- **MS Information** - the MS INFO (Mobile Subscriber Information) screen gives you access to the information about the mobile phone itself. A Location Update can be verified from this screen. This screen can be accessed by pressing:
 - **SHIFT**, **CELL CONFIG**, (MS INFO)
- **Cell Configuration** - the CELL CONFIG screen gives you access to the control parameters for the configuration of the cell. This screen can be accessed by pressing:
 - **CELL CONFIG**
- **Cell Control 2** - gives you the capability to control the additional cell parameters. This screen is relevant in the set up of a call. This screen can be accessed by highlighting the **More** field in any main screen and selecting **CELL CNTL2**.
- **Hopping** - the hopping screen allows you manual control of the hopping frequencies. This feature is only available in the Agilent 8922G compatibility mode.
- **Logging** - the logging screen allows control over the Protocol Interface port on the rear panel (option 003). To access this screen, highlight **More** and select **LOGGING**.
- **Configuration** - the configuration screen is a full instrument control screen which allows you to set up the Agilent 8922M/S. Screen set up, compatibility mode, radio type as well as other miscellaneous pieces of information are contained on this screen. To access this screen, highlight **More** and select **CONFIG**.
- **I/O Configuration** - the I/O configuration screen allows you to set up the general interface of the instrument, such as printer options. This screen can be accessed by highlighting the **More** field in any main screen and selecting **I/O CONFIG**.

Making Measurements

Advanced Features

- **SMS Cell Broadcast** - the SMS CB screen allows you to test whether the mobile phone is capable of correctly receiving and displaying a message sent from a base station using the Short Message Service (SMS) Cell Broadcast protocol. This screen can be accessed by highlighting the **More** field in any main screen and selecting **SMS CB**.

Using RF Rise Triggering

When using RF Rise triggering of measurements, the Trigger Delay should be adjusted so that the wanted data is captured during the sampling process. The actual measurement is made at the Trigger Delay time after the RF Rise. When changing from RF Rise triggering to another trigger mode, the Trigger Delay should be adjusted to the appropriate value as the default Trigger Delay is not automatically restored.

Example: In the Agilent 8922M/S, when using the RF Rise, a Trigger Delay of 0 is recommended. When changing from RF Rise to Ext Demod trigger mode, the default value of 473.4T should be re-entered for Trigger Delay.

The value 473.4T is derived from the 468.75 bits of delay between downlink and uplink plus the 4.7 bits of modulation delay inside the Agilent 8922M/S. All timing is referenced to the beginning of bit zero on the downlink TCH timeslot, (DCH or BCCH timeslot if TCH is not active.)

Effect of the RF Generator on RF Analyzer Measurements

When the RF Generator is set to a high level relative to the analyzer RF input, some error may be introduced in the analyzer's power detector. This is due to the isolation limits between generator and analyzer on the RF IN/OUT port. This only occurs when the RF Generator and RF Analyzer share the RF IN/OUT port. If the RF Generator uses the AUX RF OUT port, no error occurs.

$$Error = 10 \log \left(10^{\left(\frac{RF_{in} - 20}{10}\right)} + 10^{\left(\frac{RF_{gen} + 14}{10}\right)} \right) - (RF_{in} - 20) \text{ dBm}$$

RF_{in} is the amplitude in dBm of the signal into the RF IN/OUT port. Normally the setting in dBm of the RF Analyzer Amplitude. RF_{gen} is the setting in dBm of the RF Generator.

Because the two components are not always in phase, the actual error will often be slightly less.

Power Ramp Setting Time The mobile transmitter output ramp should settle so that it complies with the power mask (GSM Rec 11.10) by the time output level calibration is done in the manufacturing process. The power mask is displayed in the Power Ramp screens.

Peak Carrier Power measurement method is not made to GSM Rec. 11.10. If you need to make a measurement to this specification, go to the Power Ramp Summary screen. The field in the top right-hand corner displays the Peak Carrier Power to GSM Rec. 11.10. Refer to PWR RAMP: SUMMARY screen (**item 5**) for a description.

Peak Carrier Power Measurement, Assumptions And Algorithm The algorithm for the Peak Carrier Power measurement is based on the use of a fast sampler taking continuous asynchronous measurements of the power detected at the RF IN/OUT port.

The sampler accumulates 75 μ S sample bins containing the maximum power observed during the period and the minimum power observed during the period. Sampling rate is 10 MHz. The maximum and minimum values observed are based on 750 individual samples within the period.

A trigger is provided at the middle of bit 0 of the burst. (When using RF Rise triggering, the actual trigger may occur several bits earlier due to the ramp up of the burst.) In response to this trigger, the following 6 sample bins (0 - 5) from the sampler are saved and reported to the measurement processor.

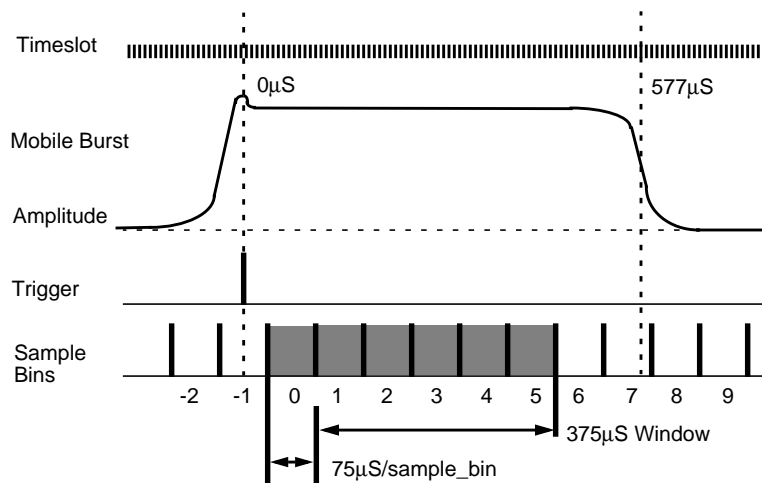

Making Measurements

Advanced Features

The beginning of the 0 sample bin will be between 0 and 75 μ S (bit 0 - 20) after the trigger as the sampler runs asynchronously to the trigger. The last sample bin will complete sampling between 450 μ S and 525 μ S (bit 121 - 142) into the burst.

The measurement processor discards the 0 sample bin. This effectively removes the ramp-up overshoot. Each measurement is also RF Power Qualified to ensure only valid bursts are measured. Measurements with a result below the qualification level are discarded.

The remaining sample bins 1-5 are averaged for the displayed measurement result. Each measurement is therefore based on a 375 μ S (102 bit) sampling of the burst.

A mobile which does not meet the amplitude mask and has erratic amplitude across the burst could give erroneous results with this measurement algorithm. It is therefore essential that mobiles first comply with the amplitude mask in GSM Rec. 11.10.

Making Synchronized External Measurements Using Triggers From The Agilent 8922M/S

There are two ways of making a synchronized external measurement using triggers from the Agilent 8922M/S:

- 1 Use the G_EXT_TRIG on the rear panel SYSTEM_BUS connector. See Chapter 6, Connectors for a pin out diagram.

This is a separate trigger directly from the Protocol Processor. It is only selectable from the SERVICE screen. Once set it will provide continuous triggers on each frame. Caution must be used as this trigger can have up to a 0.75 bit error due to the 156/157 bit variance in timeslots.

(GSM Recommendations allow use of 156/157 bit timeslots instead of the 156.25 bit length.)

To use the G_EXT_TRIG signal:

Go to the CONFIG screen.

Select the SERVICE field on the right hand side of the screen.

Select the LATCH field and find the selection labeled:

'g_ext_trig_enable' (SERV:LATCH:SEL 'g_ext_trig_enable')

Enter a '1' in the VALUE field. (SERV:LATCH:VAL 1)

Select the LATCH field and find the selection labeled:

'g_ext_trig' (SERV:LATCH:SEL 'g_ext_trig')

Enter the TIMESLOT and BITPOSITION on which you want the trigger to occur.

Example: 432 hex is TIMESLOT=4 BITPOSITION=32 hex. The maximum TIMESLOT=7 and the maximum BITPOSITION=9C hex (Bit 0 - 157).

NOTE

The GPIB requires the use of base 10 values, 432h = 1074d, for example:
SERV:LATCH:VAL 1074.

The value entered is relative to the beginning of the zero bit of the zero slot on the downlink baseband.

A 4.7 bit modulator delay occurs between the baseband and the RF domain which must also be taken into account. Since the value may only be integer, round to the nearest whole value.

The following timing error is introduced due to 156/157 bit timing.

Timeslot=0,4 No Error

Timeslot=1,5 +.75 bit error (early trigger)

Timeslot=2,6 +.50 bit error

Timeslot=3,7 +.25 bit error

- 2 Use MEAS_TRIG_OUT on the rear panel SYSTEM_BUS connector.

This is the delayed trigger from the Measurement System. In the normal ACTIVATED operation, the Protocol Processor sends triggers to the Measurement System on the zero bit of each downlink TCH burst. The Measurement System applies the 'Meas Trig' 'Trigger Delay' to this input and then, after the elapsed time, begins making its measurement. After this elapsed time, the Measurement System also sends a trigger transition to the MEAS_TRIG_OUT signal on the rear panel SYSTEM_BUS connector.

The trigger is only generated when a measurement is being made. This signal may be used to trigger an externally connected measurement device such as the HP/Agilent 71150/250 GSM high performance spectrum analyzers.

Making Measurements

Advanced Features

Unexpected Operations

These are descriptions of operations which may be unclear to the user as to how they occurred. These are NOT defects.

- 1 The Agilent 8922M/S occasionally sends ABORTS to the attached protocol monitor. These ABORTS are normal and logging data is not lost.
- 2 In the FA and SD/4+FA control channel configurations, the Agilent 8922M/S sends speech frames rather than fill frames on the FACCH when there is nothing else to send.
- 3 The DRX ON mode corresponds to the NORMAL paging mode. The Agilent 8922M/S sends continuous paging mode NORMAL on the idle PCH blocks. The DRX OFF mode corresponds to the REORGANIZE paging mode. The Agilent 8922M/S sends continuous paging mode REORGANIZE on the idle PCH blocks. When in the REORGANIZE paging mode, the Agilent 8922M/S is guaranteed to page on a random PCH block which is *not* the block expected in the NORMAL paging mode. The active PCH block will page the MS with the paging mode set to SAME. The SAME mode means “the same paging mode as last indicated.”
- 4 TMSI reallocation in the Agilent 8922M/S uses the two (2) octet TMSI size.
- 5 The Agilent 8922M/S does not turn off the transmitter during DTX when the voice activity detector (VAD) determines that there is no speech input present. Instead, the Agilent 8922M/S sends a silence descriptor (SID) on every speech frame.
- 6 USE MEM is not intended to be used with Pulse (Pulse ON/OFF Ratio) measurements - do not select USE MEM after making a pulse measurement.
- 7 During a Pulse (Pulse ON/OFF Ratio) measurement the following message can occur if the device under test is generating a larger signal than is expected: ‘RF Overpower occurred during Pulse On/Off Ratio measurement’. This message cannot be queried via GPIB. Use the Hardware 1 Status Register Bit 5 to detect this condition when doing pulse measurements.

NOTE

Option 006 (spectrum analyzer) must be installed to make pulse measurements.

- 8 The Output RF Spectrum measurement and Pulse On/Off Rise and Fall measurement results shown on the **Main** view screens are not accessible via GPIB or IBASIC. These measurement results are available on the **Trace** view screens. All GPIB and IBASIC actions with these fields refer to those fields shown on the **Trace** view screens.

- 9 The RF Generator may become uncalibrated in a hopping situation when the last CW frequency setting was outside the GSM or DCS band. If you are using the RF Generator outside the normal GSM or DCS bands, make sure you set a valid GSM or DCS frequency in the CW frequency before entering a hopping mode. This includes the ACTIVE CELL (ACTIVATED state on the CELL CONFIG 2 screen) on the Agilent 8922M/S.
- 10 When using RF Rise triggering it is recommended to set MS_Parms:Timing Advance to MANUAL with the Timing Advance set to zero. If AUTO timing advance is used with RF Rise triggering, the Agilent 8922M/S, operating as a base station, will progressively command the mobile to advance timing until it is at the maximum value of 64. It is difficult to recover from this state without ending the call with the mobile. Changing back to EXT_DEMOD triggering will cause the call to drop. This is because the Agilent 8922M/S is listening for the mobile 64 bits later than the RF Rise triggering left it.
- 11 When making measurements over the GPIB, it is often necessary to place time-out constraints in software to account for mobile failure. When a time-out is encountered while a measurement is armed but not complete, it is necessary to perform a "CLEAR" operation on the GPIB. A "RESET" operation is insufficient.

Example

```
ASSIGN @gpiB TO 714
OUTPUT @gpiB;"TRIGger:AState 'ARM'"
ON TIMEOUT 7,5 GOTO Flag1
OUTPUT @gpiB;"MEASure:DSP:PHASe:FREQuency?"
ENTER @gpiB;The_answer
PRINT 'FREQUENCY: '; The_answer
OFF TIMEOUT 7
GOTO Flag2
Flag1:OFF TIMEOUT 7
CLEAR @gpiB
PRINT "Timeout Occurred"
OUTPUT @gpiB;"TRIGger:AState 'DISARM'"
Flag2:END
```

Making Measurements

Advanced Features

12 Some measurement results may be displayed as ---- due, for example, to mobile failure. The measurement has been armed but has not completed. In these circumstances a GPIB query of the measurement will not return a result. This event should be catered for by adding a time-out to the query and a “CLEAR” operation as described in paragraph 11, above.

13 When changing between screens, the DSP results may briefly show a very large number. This is expected behavior.

When controlling the instrument via GPIB, some phase and frequency results may consistently return a very large number. This is most likely caused by attempting to read result from another DSP screen when measurement triggering is set to **Continuous**. The alternative solutions are either to change to the appropriate DSP screen before reading the result, or to use single-shot measurement triggering.

Verifying Performance

About This Chapter

The tests in this chapter verify the electrical performance of the Agilent 8922M/S GSM Test Set using the Agilent 8922 Performance Test Software provided with the product. If the instrument passes this verification, its operation and specifications are assured within the measurement uncertainties provided in the performance test print out. Because of the specialized nature of the Agilent 8922M/S and the equipment required to support it, it is recommended that calibration and repair be performed only by specially equipped Agilent Technologies service centers.

A list of specifications is found at the end of this chapter.

Setting up the Tests

This chapter contains the following information:

Getting the Right Test Equipment

Required Test Equipment lists the test equipment needed for the performance tests. This is the only equipment supported by the Agilent 8922 Performance Test Software and is required to verify instrument operation. Equipment substitutions or manual performance tests are not recommended or supported by Agilent Technologies.

Installing and Operating the Software

Performance Test Software describes how to install and operate the Agilent 8922 Performance Tests software.

Getting the Right Equipment

The following equipment is required to do all of the performance tests. The test descriptions have an equipment list that specifies the equipment used for each particular test.

| Equipment | HP/Agilent Model Number |
|--|--------------------------------|
| Measuring Receiver | 8902A |
| Sensor Module | 11722A |
| Audio Analyzer | 8903B |
| Voltmeter | 3456A |
| Signal Generator | 8657A/B Opt. 022 |
| Multifunction Synthesizer | 8904A Opt. 001/002 |
| Pulse Generator | 8116A |
| Spectrum Analyzer | 8566B |
| Technical Computer with Rocky Mountain BASIC and DS Disk Drive | HP9000 Series 200/300 |
| GPIB/RS-232 printer | HP 2225A |

Installing and Operating the Software

Performance Test Software is supplied on a 3.5-inch, double-sided floppy disk and is written to run with BASIC 5.0 and later. Modifications to the program should be limited to changing the default addresses and storing copies for back-up purposes.

Understanding the Tests

Test Descriptions contains a description of each test that is performed by the Performance Test software. This description is intended to help locate problems if the software fails to execute properly or to help users understand the test methodology that is used in each performance test. The descriptions are not step by step procedures for manual performance tests.

To Load the Program.

To verify the performance of the Agilent 8922M, you need to convert the instrument back from an Agilent 8922G, or convert the Agilent 8922S to an Agilent 8922E. To do this refer to the following section titled "Using the Compatibility Switch - Back Conversion".

You are now ready to run the Performance Test Software.

- 1 Put the disk in the disk drive.
- 2 Type **LOAD "PT_8922"**, press **ENTER**.

After you have completed the Performance Tests, return the instrument back to the Agilent 8922M or Agilent 8922S by following the instructions in the following section titled "Using the Compatibility Switch - Forward Conversion".

Using the Compatibility Switch

Back Conversion

To turn the instrument from the Agilent 8922M/S back to an Agilent 8922G or an Agilent 8922E, select the following keys:

- **CONFIG** (this is accessible from the Cell Control screen in the bottom right-hand corner).
- **Compatible**, select 8922G or 8922E
- **HP-IB Adrs** (22)
- **PRESET**

The instrument is now set up as an Agilent 8922G or Agilent 8922E and ready for Performance Verification testing.

Forward Conversion

To return the instrument from an Agilent 8922G back to an Agilent 8922M or an Agilent 8922E to an Agilent 8922S, select the following keys:

- **More** (this is accessible from the Cell Control screen in the bottom right-hand corner). Scroll down the list and select **CONFIG**.
- **Compatible**, select 8922M or 8922S
- **HP-IB Adrs** (14)
- **PRESET**

The instrument is returned to an Agilent 8922M or Agilent 8922S.

To Configure the GPIB Addresses

- 1 With the program loaded, type **EDIT DEFAULT_ADDRESS**, press **ENTER**.
- 2 Modify each line to indicate the proper instrument address (700-730).

It is now possible to re-store the program as "PT_8922" or store it under a different name.

To Run the Program

- 1 Type **RUN**, press **ENTER**.
- 2 Follow the directions as they appear on the screen.

Notes on Running the Program.

The first screen which appears is the GPIB status of each piece of test equipment that is supported. It is only necessary to have the instruments responding that will be used in each particular test. Make certain that each instrument you will be using is responding at the proper address. Duplicate addresses may make an instrument appear to be responding but this is not allowed. Press "I" (for Ignore) to continue past this screen.

The second screen prompts you for the instrument model. If you have disk 08922-10006, select HP 8922G (for Agilent 8922M performance testing) or HP 8922E (for Agilent 8922S performance testing). The third screen which will appear is the main Performance Tests selection menu. Three options are available on this screen:

- Select the performance test to run, remember the test instruments and UUT must be responding over GPIB.
- Turn the printer function ON or OFF. If the printer function is turned on it must be responding over GPIB or the program will lock up.
- Exit from the program.

Press the key corresponding to the option that you would like to perform. The other screens that appear are connection instructions, error messages and output results.

Understanding the Tests

This section describes the theory of each performance test, lists the equipment needed for the test, and provides some problem solving information.

Test 01: Signal Generator Level

Equipment Required

Measuring Receiver HP/Agilent 8902A

Sensor Module HP/Agilent 11722A

Theory of the Test

The UUT is set to generate CW signals at various levels and frequencies. The HP/Agilent 8902A/11722A is used as a power meter to measure high level signals and the HP/Agilent 8902A tuned RF level function is used to measure low level signals.

Things To Check In Case Of Problems

- The HP/Agilent 8902A/11722A must be calibrated and zeroed for accurate measurement results. The HP/Agilent 11722A calibration factors must be entered into the HP/Agilent 8902A.
- Low level signals from the Agilent 8922M/S must be very stable to be measured by the tuned RF level function of the HP/Agilent 8902A. The instrument timebases should be locked together. Also, if the Agilent 8922 source has unusually high residual FM it may cause the low level measurements to fail because the HP/Agilent 8902A cannot lock onto the signal.
- Mismatch uncertainty causes a high level of uncertainty in this measurement.

Verifying Performance
Understanding the Tests

**Test 02: Signal
Generator Spectral
Purity**

Equipment Required

HP/Agilent 8566B Spectrum Analyzer

Theory of the Test

The UUT is set to generate a CW signal at various levels and frequencies. The HP/Agilent 8566B is used to measure the signal level and then the level of the harmonics or spurious signals.

Things To Check In Case Of Problems

- The instruments should have their timebases locked together to assure that the frequency offsets for the spurious measurements are accurate.

**Test 03: Signal Pulse
Modulation**

Equipment Required (excluding Agilent 8922M/S)

HP/Agilent 8116A Pulse Generator

Theory of the Test

The HP/Agilent 8116A pulse generator drives the pulse input of the UUT and causes it to generate pulsed RF signals. These signals are detected with the negative diode detector and analyzed with the oscilloscope. The UUT is set to generate two different on/off ratios: 30 dB and 80 to 90 dB. Rise time and fall time for each of these is measured.

When the Agilent 8922S is the UUT, the RF Generator is set to generate a pulsed GMSK signal. This signal is then analyzed with the UUT detector and oscilloscope.

Things To Check In Case Of Problems

- The oscilloscope is used to automatically measure rise and fall times. If the RF signal has high video feedthrough, it may cause the oscilloscope to make a faulty reading by triggering on the video feedthrough instead of the actual pulse.
- A diode detector with a greatly different sensitivity may cause the demodulated waveform to overrange on the oscilloscope or have reduced accuracy because of the resolution of the oscilloscope.

**Test 04: Signal
Generator 0.3
GMSK Modulation**

Equipment Required (excluding Agilent 8922S)

HP/Agilent 8904A Option 001/002 Multifunction Synthesizer

Theory of the Test

The HP/Agilent 8904A is used to generate a 270.833 kHz clock and random data. This drives the UUT RF generator to generate the 0.3 GMSK modulated signals with random data. This signal is then analyzed by the UUT to assure that the frequency and phase errors are correct.

If the UUT is an Agilent 8922S, clock and data signals are generated internally, and the HP/Agilent 8904A is not used.

Things To Check In Case Of Problems

- This test should only be performed if the UUT analyzer is known to be accurate. Run test #9 first if there is any question about the accuracy of the UUT analyzer.
- Even when the accuracy of the UUT analyzer is known, its specification is such that this test still has a high degree of measurement uncertainty.
- A possibility to verify an instrument that fails this test may be to use a second Agilent 8922M/S to analyze the signal or use the HP/Agilent 11836A 0.3 GMSK measurement software. This software (and its associated hardware) has a lower measurement uncertainty but is not currently supported with the Agilent 8922 Performance Tests software.

**Test 05: Audio
Frequency
Generator**

Equipment Required

HP/Agilent 3456A Voltmeter

HP/Agilent 8903BAudio Analyzer

HP/Agilent 8902A Measuring Receiver

Theory of the Test

The UUT is set to generate audio signals at various levels and frequencies. The voltmeter measures AC and DC level accuracy, the audio analyzer measures residual distortion, and the measuring receiver measures frequency accuracy.

Things To Check In Case Of Problems

- The measuring receiver and the UUT should have their timebases locked to make accurate frequency measurements.

Verifying Performance
Understanding the Tests

**Test 06: Audio
Frequency Analyzer**

Equipment Required

HP/Agilent 8904A Option 001/002 Multifunction Synthesizer
HP/Agilent 3456A Voltmeter

Theory of the Test

The HP/Agilent 8904A is used to generate accurate test signals which are analyzed by the UUT. The voltmeter is used to reduce measurement uncertainty by accurately characterizing the test signal level to predict the correct response of the UUT. The voltmeter is used in the AC level, DC level, SINAD and distortion measurements. Distortion test signals are generated by summing two sinewaves in the HP/Agilent 8904A, one as the desired signal, the other as a distortion product.

Things To Check In Case Of Problems

- For frequency accuracy measurements the HP/Agilent 8904A timebase should be locked to the UUT.
- The voltmeter reading is used as a reference to normalize the reading from the UUT. The output “measured” result is the actual reading from the UUT normalized by the actual reading from the voltmeter. If the voltmeter makes a faulty reading, it will normalize the actual UUT response and cause it to appear faulty also. If the front panel reading from the UUT is significantly different from the printed “measured” response, the normalization may be the cause.

Test 07: Oscilloscope **Equipment Required**

HP/Agilent 8903B Audio Analyzer
HP/Agilent 3456A Voltmeter

Theory of the Test

The audio analyzer is used to generate CW reference signals which are characterized by the voltmeter and fed into the UUT. The voltmeter reading is used to normalize the reading from the UUT oscilloscope. The oscilloscope measurements are taken using the UUT marker function which is set to the peak of the input sinewave.

Things To Check In Case Of Problems

- The voltmeter reading is used as a reference to normalize the reading from the UUT. The output “measured” result is the actual reading from the UUT normalized by the actual reading from the voltmeter. If the voltmeter makes a faulty reading, it will normalize the actual UUT response and cause it to appear

faulty also. If the front panel reading from the UUT is significantly different from the printed “measured” response, the normalization may be the cause. If the oscilloscope triggers incorrectly, the peak search may not find the actual peak response on the display.

Test 08: RF Analyzer Level **Equipment Required**

HP/Agilent 8657A/B Signal Generator

HP/Agilent 8902A Measuring Receiver

HP/Agilent 11722A Sensor Module

Theory of the Test

The signal generator is used to generate CW signals at various frequencies and power levels. These are accurately characterized by the HP/Agilent 8902A/11722A and used as a reference. The CW signals are then used to test the UUT which is compared to the reference reading taken by the HP/Agilent 8902A/11722A.

Things To Check In Case Of Problems

- Mismatch uncertainties cause a high level of measurement uncertainty in this measurement. If the HP/Agilent 11722A or HP/Agilent 8657A/B has a high SWR, the accuracy of the results may be reduced.

Test 09: RF Analyzer GMSK Modulation **Equipment Required**

HP/Agilent 8116A Pulse Generator

HP/Agilent 8904A Opt. 001/002 Multifunction Synthesizer

HP/Agilent 8657A/B Option 022. Signal Generator

Theory of the Test

The HP/Agilent 8904A frequency modulates the GMSK signal generator with a known amount of phase error. This test signal is used to verify the UUT’s ability to measure this known signal. The actual measurements are compared to the predicted to determine the accuracy of the UUT. The HP/Agilent 8904A is also used to create the 270.833 kHz clock signal and the pulse generator is used to create a random data pattern. Polarity of the data signal from the HP/Agilent 8657A/B Option 022 is not important in this measurement.

Things To Check In Case Of Problems

- Make certain the option 022 part of the 8657A/B is locked up to the 270.833 kHz

Verifying Performance
Understanding the Tests

clock signal. The option does not have GPIB control so the program cannot verify that the option is operational.

**Test A: RF Analyzer
Pulse Demodulation**

Equipment Required

HP/Agilent 8657A/B Signal Generator

HP/Agilent 8116A Pulse Generator

Theory of the Test

The Pulse generator drives the signal generator to generate Pulsed RF signals at various frequencies. The UUT demodulates these signals and the internal oscilloscope measures the rise and fall time of the demodulated waveform. This test verifies the demodulator rise and fall time specifications.

Things To Check In Case Of Problems

- The oscilloscope measurement functions are used to measure the 10% to 90% rise and fall time. If the demodulated waveform has significant video feedthrough or the oscilloscope cannot trigger the measurements properly, an incorrect measurement may result.

**Test B: Spectrum
Analyzer (Option
006 only)**

Equipment Required

HP/Agilent 8657A/B Signal Generator

Theory of the Test

The signal generator is used to stimulate the UUT spectrum analyzer at various frequencies. At each frequency, the spectrum analyzer is tuned to measure its own image and spurious responses. The level of the signal generator is set to various levels to determine the spectrum analyzer's log-linearity.

Things To Check In Case Of Problems

- The absolute accuracy of the signal generator causes a significant measurement uncertainty in the log linearity measurements. A more accurate measurement is to reduce the signal level using a precision attenuator. This is an acceptable secondary manual test if the UUT fails the automated test.

Understanding Test Failures

This section is intended to be used in conjunction with the *Agilent 8922 Series Assembly Level Repair Guide* for assembly level repair and troubleshooting. If a performance test fails and hardware is suspected, the following table is a guideline to help identify the hardware assemblies most likely to cause each failure. Before replacing an assembly, the memory card diagnostics (supplied with the Assembly Level Repair Guide) should also be run to help verify which assembly is defective.

| ASSEMBLIES TESTED (P=Primary S=Secondary) | | | | | | | | | | | | | | | | | | | | | |
|---|----|----|----|----|----|----|-----|-----|-----|-----|-----|-----|-----|-----|-----|-----|-----|-----|-----|-----|--|
| Performance Test | A2 | A3 | A4 | A5 | A6 | A9 | A11 | A12 | A13 | A14 | A15 | A16 | A17 | A18 | A19 | A23 | A24 | A25 | A26 | A27 | |
| Sig Gen Level | | | | S | | | | S | P | | S | | | | | P | S | S | S | S | |
| Sig Gen Spectral Purity | | | | S | | | | S | S | | S | | | | | S | S | S | S | S | |
| Sig Gen Pulse Mod | | | | S | | | | P | S | P | S | | | | | S | S | S | S | S | |
| Sig Gen .3 GMSK | | | | P | | | | S | S | S | S | | | | | S | S | S | S | P | |
| AF Generator | | | S | | S | | | | | | | | | | | | | | | | |
| AF Analyzer | P | P | | | | | | | | | | | | | S | | | | | | |
| Oscilloscope | | | S | | | | | | | | | | | | S | | | | | | |
| RF Analyzer Power | | | | | | | | | | | | | | | S | P | | | | | |
| RF Analyzer GMSK Mod | | | | | | P | S | | | | | P | S | | | S | | | | | |
| RF Analyzer Pulse Demod | | | | | | | S | | | | | P | S | | | S | | | | | |
| Spectrum Analyzer | | | | | | | S | | | | | S | S | P | | S | | | | | |

Agilent Technologies 8922M/S Specifications

NOTE: If you have the **Agilent 8922M/S Option 010 Multi-Band Test System**, refer to the appropriate *Agilent 8922 Multi-Band User's Guide* for more information on specifications relevant to dual band testing.

GSM900 and E-GSM900 Functionality

| | |
|---|--|
| Bit/Frame Error Rate Measurements: | Class 1a, 1b, and Class II bits in both raw and residual form. Also Burst-by-Burst Bit Error Measurement |
| MS Power Output Level Control: | 0 to 19 with RF analyzer auto adjust |
| Broadcast Channel Capability: | BCCH + CCCH or BCCH + CCCH + SDCCH/4 |
| Control Channels (SDCCH, FACCH, SACCH) | BCCH + CCCH, BCCH + CCCH + SDCCH/4, SDCCH/8 (non-hopped), SACCH/FACCH |
| Call Control Capabilities | BS originated call (FS/EFS), MS originated call (FS/EFS), MS camp on, BS call disconnect, MS call disconnect |
| Traffic Channels | TCH (FS/EFS) |
| HSCSD | 2x1 and 2x2, 9.6 kbs and 14.4 kbs |
| Timing | Auto, manual, uplink-downlink, offset measurement |
| Hopping | Two independent, user definable MA tables with offsets |
| Speech Encoding/Decoding | Full rate speech |
| Speech Echo Mode | User selectable delay 0 to 5 sec on Agilent 8922M, fixed delay on Agilent 8922S |
| Measurement Coordination | Flexible control of burst type, ARFCN, and timeslot. |
| SACCH MEAS Result | RXLEV, RXQUAL, and timing advance. |
| SMS Cell Broadcast | Two predefined messages with user definable attributes (code, update number, language and identifier). |

RF Generator Specifications

| | Frequency |
|-------------------|---------------------------------|
| Range | 10 MHz to 1 GHz |
| Resolution | 1 Hz |
| Accuracy | Reference accuracy ± 0.5 Hz |
| Stability | Same as reference |

| | |
|--------------------------------------|--|
| Supplemental Characteristics: | |
| Frequency Overrange | <i>To 1015 MHz with uncalibrated output and modulation</i> |
| Switching Speed | <i>577 μs over the GSM frequency bands in hop mode (refer to 0.3 GMSK modulation specs)</i> |

Output

| | |
|-----------------------------------|---|
| RF In/Out Connector | |
| Level Range | -14 to -127 dBm |
| Level Resolution | 0.1 dB |
| Level Accuracy² | |
| GSM Bands¹ | ± 1.0 dB, levels ≥ -127 dBm, maximum over range > -12 dB ± 1.0 dB, typically for levels ≥ -127 dBm while hopping. |
| 50 MHz to 1 GHz | ± 1.5 dB, levels ≥ -107 dBm ± 2.0 dB, levels ≥ -127 dBm |
| 10 MHz to 50 MHz | ± 2.0 dB, levels ≥ -107 dBm ± 2.5 dB, levels ≥ -127 dBm |
| Reverse Power | 15 Watts continuous 100 Watts for 10 seconds/minute |
| SWR | 1.5:1 |
| Aux RF Out Connector | |
| Level Range | +4 to -127 dBm |
| Level Resolution | 0.1 dB |
| Level Accuracy² | |
| GSM Bands¹ | ± 1.0 dB, levels ≥ -107 dBm ± 1.0 dB, typically for levels ≥ -107 dBm while hopping. |
| 50 MHz to 1 GHz | ± 1.5 dB, levels ≥ -107 dBm ± 2.0 dB, levels ≥ -127 dBm |
| 10 MHz to 50 MHz | ± 2.0 dB, levels ≥ -107 dBm ± 2.5 dB, levels ≥ -127 dBm |
| Reverse Power | 200 milliwatts |
| SWR | 2.0:1, level < -4 dBm |

1. GSM frequency bands are 880 to 915 MHz and 925 to 960 Mhz.

2. Level accuracy degrades 0.2 dB when using the RF in/out connector for both RF generator and RF analyzer. In 30dB pulse mode, level accuracy specifications are typical.

Spectral Purity

| | |
|---|--|
| Spurious Signals (for $\leq +1$ dBm output level at Aux RF Out or ≤ -19 dBm output level at RF In/Out. | |
| Harmonics: | < -25 dBc |
| Non-harmonics: | < -50 dBc, > 5 kHz offset from carrier |

0.3 GMSK Modulation

After one timeslot, 577 μ s, from an isolated RF Generator Trigger in the GSM Frequency bands.

| | |
|--|--|
| Phase Error | $\leq 1^\circ$ rms |
| Peak Phase Error | $\leq 4^\circ$ peak |
| Frequency Error | $\pm [0.02 \text{ ppm (18 Hz) + reference accuracy}]$, for normal bursts <i>Typically $\pm [0.03 \text{ ppm (27 Hz) + reference accuracy}]$, for RACHs.</i> |
| Amplitude Flatness | ± 0.25 dB peak. |
| Clock Input (Agilent 8922M only) | |
| Frequency | 270.833 kHz \pm 2 Hz (relative to reference). |
| Level | TTL |
| Data Input (Agilent 8922M only) | |
| Format | Non differentially encoded input. |
| Level | TTL |
| Supplemental Characteristics: | |
| After three timeslots, 1.73 ms, from an isolated RF Generator Trigger in the GSM frequency bands | |
| Phase Error | $\leq 0.5^\circ$ rms |
| Peak Phase Error | $\leq 2.0^\circ$ peak |
| Frequency Error | $\pm [0.01 \text{ ppm (9 Hz) + reference accuracy}]$ for normal bursts. $\pm [0.02 \text{ ppm (18 Hz) + reference accuracy}]$ for RACH bursts. |

Pulse Modulation

| | |
|--|------------------|
| Input Levels (Agilent 8922M only) | TTL |
| Rise/Fall Time (10% to 90%) | ≤ 5 μ s |
| Supplemental Characteristics: | |
| On/Off Ratio | > 80 dB |

30 dB Pulse Modulation (Agilent 8922M only)

All timeslots 30 dB higher than desired/active timeslot, to test adjacent timeslot rejection.

| | |
|--------------------------------------|----------------------|
| Supplemental Characteristics: | |
| Input Levels | TTL |
| Rise/Fall Time (10 to 90%) | $\leq 5 \mu\text{s}$ |

AM for Level Control (Agilent 8922M Only)

For output levels $\leq +1$ dBm at Aux RF Out or ≤ -19 dBm at RF In/Out

| | |
|--------------------------------------|--|
| Supplemental Characteristics: | |
| Input | |
| Range | -1.0V to +0.6V |
| Impedance | 600 Ω nominal, DC Coupled |
| Sensitivity | 100% AM per volt, nominal |
| Calibration | 0 VDC input produces calibrated output from the RF Generator |
| Rise/Fall Time (10 to 90%) | $\leq 10 \mu\text{s}$ |

Verifying Performance
 Agilent Technologies 8922M/S Specifications

RF Analyzer Specifications

Frequency

| | |
|--------------------------------------|--------------------------------|
| Range | 10 MHz to 1 GHz |
| Resolution | 1 Hz |
| Hop Mode | |
| Resolution | 100 kHz |
| Offset Frequency | ≤50 kHz |
| Offset Resolution | 1 Hz |
| RF In/Out SWR | <1.5:1 |
| Supplemental Characteristics: | |
| Frequency Overrange | To 1015 MHz |
| Offset Resolution | 500 Hz for FM demodulation out |

CW RF Frequency Measurement

| | |
|--------------------------------------|------------------------------|
| Range | 10 MHz to 1 GHz |
| Level Range | |
| RF In/Out | -6 to +41 dBm |
| Aux RF In | -36 to +20 dBm |
| Input Frequency Setting Error | ±500 kHz |
| Accuracy | ±(1 Hz + reference accuracy) |
| Supplemental Characteristics: | |
| Minimum Resolution | 1 Hz |

CW RF Power Measurements (RF In/Out Only)

| | |
|--------------------------------------|--|
| Range | -5 to +41 dBm |
| Input Frequency Setting Error | ±500 kHz |
| Accuracy | ±0.5 dB ± noise effects (+4 to +41 dBm) (0.2 mW) |
| Supplemental Characteristics: | |
| Accuracy | ±0.5 dB ± noise effects (-5 to +4 dBm) (0.2 mW) |
| Minimum Resolution | 0.01 dB |

Peak/Transmitter Carrier Power Measurement

RF In/Out only. After one timeslot, 577 μ s, from an isolated Receiver Hop Trigger in the GSM bands.

| | |
|--------------------------------------|---|
| Range | -5 to +41 dBm |
| Input Frequency Setting Error | ± 10 kHz |
| Input Level Setting Error | ± 3 dB |
| Accuracy | ± 0.6 dB \pm noise effects (+4 to +41 dBm) (0.2 mW) |
| Supplemental Characteristics: | |
| Accuracy | ± 0.6 dB \pm noise effects (-5 to +4 dBm) (0.2 mW) |
| Minimum Resolution | 0.2 dB |

Power Measurement Accuracy

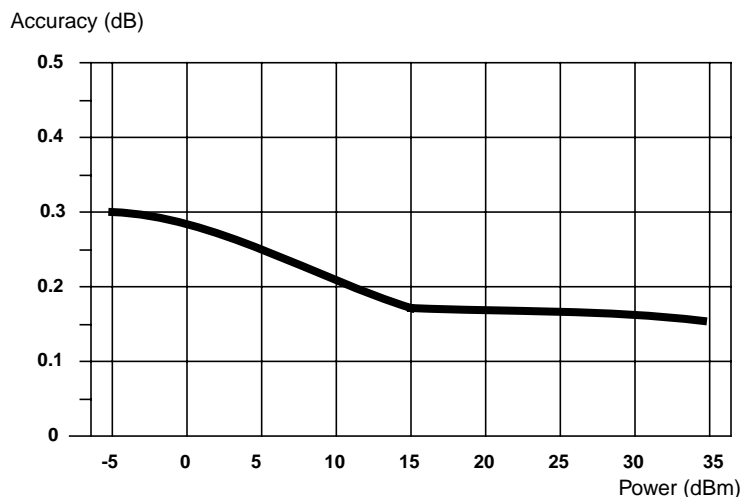

Pulse ON/OFF Ratio Measurement (Requires Option 006)

ON power is averaged over the useful part of the burst. OFF is averaged over a one bit interval centered at a user specified time. Non-hopped mode only.

| | |
|--------------------------------------|--|
| Input Frequency Setting Error | ± 10 kHz |
| Input Level Setting Error | ± 3 dB |
| Timing Accuracy | ± 1.7 μ s (± 1.1 μ s typical) |

Verifying Performance
 Agilent Technologies 8922M/S Specifications

Accuracy (ON/OFF 40 dB, RF In/Out only)

| OFF Power (dBm) | ON/OFF Ratio Accuracy | |
|-----------------|-----------------------|----------------|
| -30 to -1 | ±2.4 dB | ±1.1 typically |
| -37 to -30 | ±2.9 dB | ±1.3 typically |
| -42 to -37 | ±3.7 dB | ±1.7 typically |
| -47 to -42 | ±4.2 dB | ±2.1 typically |

Amplitude Envelope Measurement

After one timeslot, 577µs, from an isolated Receiver Hop Trigger in the GSM Frequency bands

| | |
|--------------------------------------|---------------|
| Measurement Range | |
| RF In/Out | -6 to +41 dBm |
| Aux RF In | -36 to 20 dBm |
| Input Frequency Setting Error | ±10 kHz |

Inaccuracy due to Noise (for overshoots ≤ 1 dB):

| Relative Level | Input Level Setting Error | | |
|----------------|---------------------------|-------------|--------------------|
| | ±1 dB | ±3 dB | ±3 dB w/5 averages |
| 0 dB | <±0.15 dB pk | <±0.2 dB pk | <±0.2 dB pk |
| -6 dB | <±0.2 dB | <±0.3 dB | <±0.3 dB |
| -30 dB | <+3.0 dB | <+4.2 dB | <+2.2 dB |
| | -3.8 dB | -7.5 dB | -2.6 dB |

Phase and Frequency Measurements

After one timeslot, 577 μ s, from an isolated Receiver Hop Trigger in the GSM Frequency bands.

| | |
|--|--|
| Range | |
| RF In/Out | −6 to +41 dBm |
| Aux RF In | −36 to +20 dBm |
| Input Frequency Setting Error | ± 10 kHz |
| Input Level Setting Error | ± 3 dB |
| RMS phase error accuracy | $\leq 1^\circ$ rms |
| Peak phase error accuracy | $\leq 4^\circ$ peak |
| Frequency error accuracy | $\pm [0.02 \text{ ppm (18 Hz) + reference accuracy}]$, for normal bursts. <i>Typically $\pm [0.03 \text{ ppm (27 Hz) + reference accuracy}]$ for RACH bursts.</i> |
| Supplemental Characteristics | |
| After three timeslots, 1.73 ms, from an isolated Receiver Hop Triggering the GSM frequency band. | |
| RMS phase error accuracy | $\leq 0.5^\circ$ rms |
| Peak phase error accuracy | $\leq 2^\circ$ peak |
| Frequency error accuracy | $\pm [0.01 \text{ ppm (9 Hz) + reference accuracy}]$, for normal bursts. $\pm [0.02 \text{ ppm (18 Hz) + reference accuracy}]$ for RACH bursts. |

0.3 GMSK Data Recovery (Agilent 8922M only)

After one timeslot, 577 μ s, from an isolated Receiver Hop Trigger in the GSM Frequency bands

| | |
|--------------------------------------|--|
| Range | |
| RF In/Out | −6 to +41 dBm |
| Aux RF In | −36 to +20 dBm |
| Input Frequency Setting Error | ± 100 Hz |
| Required Input Phase Accuracy | $\leq 5^\circ$ rms, $\leq 20^\circ$ peak |
| Demodulation Duty Cycle | 1 timeslot per frame |
| Outputs | Data, Clock and Data Valid |
| Data Output Clock | Clocked at 1 MHz rate |
| Delay, data | ≤ 1 frame (4.62 ms). |
| Output Level | TTL |

Verifying Performance
 Agilent Technologies 8922M/S Specifications

FM Demodulation Output (Agilent 8922M only)

| | |
|--------------------------------------|-------------------------------------|
| Range | |
| RF In/Out | −6 to +41 dBm |
| Aux RF In | −36 to +20 dBm |
| Sensitivity | 20μV/Hz ±5% (into an open circuit) |
| Input Frequency Setting Error | ±50 kHz, with ≤100 kHz pk deviation |
| Input Level Setting Error | ±3 dB |
| Supplemental Characteristics | |
| 3 dB Bandwidth | DC to 270 kHz |
| Output Impedance | 600 Ω |
| DC Offset | ≤5 mV |

Pulse Demodulation Output (Agilent 8922M only)

| | |
|--------------------------------------|----------------------------|
| Range | |
| RF In/Out | −6 to +41 dBm |
| Aux RF In | −36 to +20 dBm |
| Input Frequency Setting Error | ±50 kHz |
| Input Level Setting Error | ±3 dB |
| Rise Time (10 to 90%) | ≤2.5 μs |
| Fall Time (90 to 10%) | ≤2.5 μs |
| Supplemental Characteristics: | |
| Output Impedance | 600 Ω, DC Coupled |
| Output Level | 2 Vpk into an open circuit |

Output RF Spectrum Measurement (Requires Option 006)

After one timeslot, 577μs, from an isolated Receiver Hop Trigger in the GSM Frequency bands.

| | |
|---|-----------------------|
| Range | |
| RF In/Out | −6 to +41 dBm |
| Aux RF In | −36 to +20 dBm |
| Input Levels for Optimum Dynamic Range | |
| RF In/Out | +7, +17, +27, +37 dBm |
| Aux RF In | −23, −13, −3, +7 dBm |
| Input Frequency Setting Error | ±10 kHz, |
| Input Level Setting Error | ±3 dB |
| Supplemental Characteristics: | |
| Log Linearity | ±0.4 dB |
| Amplitude Flatness | ±1.0 dB |
| Amplitude Resolution | 0.4 dB |

Dynamic Range (dB)

| | Offset (kHz) | | | | | |
|------------|---------------------|------------|------------|------------|------------|--------------------|
| | 100 | 200 | 300 | 400 | 600 | 800 to 1800 |
| Range (dB) | 24 | 42 | 53 | 60 | 63 | 64 |

NOTE: When using Output RF Spectrum due to the Ramping measurement, the dynamic range is decreased by 12 dB (due to Peak Hold).

**Spectrum Analyzer
 Specifications
 (Option 006)**

| | | |
|--------------------------------------|--|------------------|
| Frequency Range | 10 MHz to 1 GHz | |
| Frequency Span/Resolution | | |
| Bandwidth (coupled) | Span | Bandwidth |
| | <50 kHz | 300 Hz |
| | <200 kHz | 1 kHz |
| | <1.5 MHz | 3 kHz |
| | ≤4 MHz | 30 kHz |
| Display | Log, 10 dB/div | |
| Display Range | 80 dB | |
| Log Linearity | ±1.1 dB | |
| Reference Level | | |
| RF In/Out | +44 to -24 dBm | |
| Aux RF In | +23 to -55 dBm | |
| Non-harmonic Spurious | | |
| Responses | -50 dBc max, for inputs ≤30 dBm | |
| Residual Responses | <-70 dBm (no input signal, 0 dB attenuation) | |
| Image Rejection | >50 dB | |
| Supplemental Characteristics: | | |
| Level Accuracy | ±2.5 dB | |
| Frequency Overrange | To 1015 MHz | |
| Displayed Average Noise Level | <-116 dBm (0 dB attenuation, <50 kHz spans). | |

Audio Source Specifications

Frequency

| | |
|-------------------------------------|-------------------|
| Range | DC to 25 kHz |
| Accuracy | 0.025% of setting |
| Supplemental Characteristics | |
| Minimum Resolution | 0.1 Hz |

Output Level

| | |
|--|--|
| Range | 0.1 mV to 4 V _{rms} |
| Maximum Output Current | 20 mA peak |
| Output Impedance | <1 Ω |
| Accuracy | ±(2% of setting + resolution) |
| Residual Distortion (THD + noise, amplitude >200 mV_{rms}) | 0.1%, 20 Hz to 25 kHz in 80 kHz BW. |
| Supplemental Characteristics | |
| Minimum Resolution | Level ≤0.01V: 50μV Level ≤0.1V: 0.5 mV Level ≤1V: 5 mV Level >1V: 50 mV |
| DC Coupled Offset | <50 mV |

Audio Analyzer Specifications

Frequency Measurement

| | |
|-------------------------------------|--|
| Range | 20 Hz to 400 kHz |
| Accuracy | ±(0.02% + 1 count + reference accuracy) |
| External Input | 20 mV _{rms} to 30 V _{rms} |
| Supplemental Characteristics | |
| Minimum Resolution | f < 10kHz: 0.01 Hz f < 100kHz: 0.1 Hz f ≥ 100kHz: 1 Hz |

Verifying Performance
 Agilent Technologies 8922M/S Specifications

AC Voltage Measurement

| | |
|---|---|
| Voltage Range | 0 V to 30 V _{rms} |
| Accuracy (20 Hz to 15 kHz), Input >1 mV_{rms} | ±3% of reading |
| Residual Noise + THD (15 kHz BW) | 175 µV |
| Supplemental Characteristics | |
| 3 dB Bandwidth | 2 Hz to 100 kHz |
| Input Impedance | 1 MΩ 145 pF at AUDIO IN |
| Minimum Resolution | 4 digits for inputs ≥100mV 3 digits for inputs <100 mV |

DC Voltage Measurement

| | |
|-------------------------------------|--------------------------------|
| Voltage Range | 100 mV to 42 V |
| Accuracy | ±(1.0% of reading + DC Offset) |
| DC Offset: | ±45 mV |
| Supplemental Characteristics | |
| Minimum Resolution | 1.0 mV |

Distortion Measurement

| | |
|---|---|
| Fundamental Frequency | 1 kHz ±5 Hz |
| Input Level Range | 30 mV _{rms} to 30 V _{rms} |
| Display Range | 0.1% to 100% |
| Accuracy | ±1 dB (0.5 to 100% distortion) |
| Residual THD + noise (15 kHz BW) | The greater of -60 dB or +175 µV |
| Supplemental Characteristics | |
| Minimum Resolution | 0.01% distortion |

Audio Filters

There are seven filters used in the Agilent 8922M/S.

- 50 Hz HPF
- 300 Hz HPF
- 300 Hz LPF
- 3 kHz LPF
- 15 kHz LPF
- 750 μ s de-emphasis
- 1 kHz notch

Audio Detectors

The audio detectors available in the Agilent 8922M/S are:

- Pk+
- Pk-
- Pk + hold
- Pk – hold
- Pk \pm /2
- Pk \pm /2 hold
- Pk \pm max
- Pk \pm max hold
- RMS

Oscilloscope Specifications

| | |
|---|---|
| Frequency Range (3 dB) | 2 Hz to 50 kHz |
| Scale/Division | 10 mV to 10 V in 1, 2, 5, and 10 steps |
| Amplitude Accuracy (20 Hz to 10 kHz) | \pm 1.5% of reading \pm 0.1 division |
| Time/Division | 10 μ s to 100 ms in 1, 2, 5, and 10 steps |
| External Trigger Level | TTL |
| Maximum voltage | |
| Scope In | 5 V peak |
| Audio In | 30 V _{rms} |
| Supplemental Characteristics: | |
| 3 dB Bandwidth | Typically >100 kHz |
| Internal DC Offset: | \leq 0.1 division for \geq 50 μ V/div sensitivity |

Verifying Performance
 Agilent Technologies 8922M/S Specifications

Remote Programming

| | |
|------------------------------|--|
| GPIB | IEEE Standard 488.2 |
| Functions Implemented | SH1, AH1, T6, L4, SR1, RL1, LE0, TE0, PP0, DC1, DT1, C4, C11, E2 |
| RS-232 | 3 wire RJ-11 connector used for serial data in and out. |
| Baud Rates | 300, 1200, 2400, 4800, 9600, and 19200 selectable. |

General Specifications

| | |
|---|---|
| Size | 177H × 426W × 574D mm (7 × 16.75 × 23 in). (nominal) |
| Weight | 32 kg, 70 lbs |
| Operating Temperature | 0° to +55°C |
| Storage Temperature | -40° to +70°C |
| Humidity | Up to 95% Relative Humidity to 40°C |
| Altitude | up to 4600 m (15,000 feet) |
| The following power requirements are for mains connected equipment, unless otherwise stated. | |
| Power  | 100, 120, 220, 240 Vac, 48 to 440 Hz, ±10% of line voltage, maximum 450 VA |
| EMC | Refer to the front section of this User's Guide for more information |
| Supplemental Characteristics Leakage | At RF Generator output levels <-40 dBm, typical leakage is <1 μV induced in a resonant dipole antenna 1 inch away from any surface except the rear panel. |

WARNING: For continued protection against fire hazard, replace the line fuse only with the same type and line rating (F 2.5A H, 250V for 220/240V operation or F 5.0A H, 250V for 100/120V operation). The use of other fuses or materials is prohibited.

WARNING: Shock hazard. No operator serviceable parts inside. Service by qualified personal only.

Cleaning To clean the instrument, use a soft, clean damp cloth to clean the front panel and covers.

Operating Environment

This instrument is designed for indoor use only.

If the instrument is subjected to Agilent Class B condensation, it is recommended that the instrument be powered up for at least 30 minutes before normal operation.

CAUTION

This instrument is designed for use in Installation Category II and Pollution Degree 2 per IEC 1010 and 644 respectively.

CAUTION

Before switching on this instrument, make sure that the line voltage selector switch is set to the voltage of the power supply and the correct fuse is installed. Assure the power supply voltage is in the specified range.

WARNING:

If this instrument is to be energized via an external auto transformer for voltage reduction, make sure that it's common terminal is connected to a neutral (earth pole) of the power supply.

WARNING:

If this instrument is not used as specified, the protection provided by the equipment could be impaired. This instrument must be used in a normal condition (in which all means of protection are intact) only.

Lifting or Carrying the instrument

To avoid potential injury, ensure that two people are employed in lifting the instrument from it's packaging and at all other times. Before attempting to lift or carry the instrument, consider the following basic lifting techniques to help avoid personal injury.

Using both arms to lift instrument

- Reach for the instrument - bend your knees and waist, and keep your back straight.
- GRASP the instrument firmly.
- LIFT with your legs.
- KEEP your shoulders level.

Verifying Performance
Agilent Technologies 8922M/S Specifications

Reference Specifications The accuracy needs for testing GSM radios require the unit to be operated with the High Stability Reference (Option 001) or an external high stability reference.

| | |
|-------------------------------------|---|
| Accuracy (after warm up) | $\pm[(\text{Time since calibration} \times \text{Aging rate}) + \text{Temperature Effects} + \text{Accuracy of calibration}]$ |
| External Reference Input | |
| Frequency | 13, 10, 5, 2, or 1 MHz, ± 30 ppm |
| Level | 0 to +10 dBm |
| Supplemental Characteristics | |
| Nominal Impedance | 50 Ω |
| 10 MHz OUT (rear panel BNC) | |
| Level | >+8.0 dBm nominal |
| Impedance | 50 Ω nominal |
| 13 MHz OUT (rear panel BNC) | |
| Level | >+8.0 dBm nominal |
| Impedance | 50 Ω nominal |

Fixed Reference Mode

| | |
|------------------------------|---|
| Aging | <2 ppm/year |
| Temperature Stability | ± 1 ppm (0° to 55°C) |
| Warm-up Time | <30 minutes, ± 2 ppm of final frequency |

Tunable Reference Mode

Allows offsetting the internal reference by a selected amount relative to the High Stability Reference (Option 001) or an External Reference.

| | |
|---|--|
| Required External Reference Accuracy | ± 0.5 ppm |
| Tune Range | ± 30 ppm |
| Reference Accuracy | ± 1 ppm + accuracy of External Reference or High Stability (Option 001). |
| Temperature Stability | ≤ 4 ppm, for selected offsets of up to ± 30 ppm. |

The Video Out connector on the rear panel outputs a 15 kHz PAL CVBS underscanning compatible signal.

Screens

NOTE

If you have the **Agilent 8922M/S Option 010 Multi-Band Test System**, refer to the appropriate *Agilent 8922 Multi-Band User's Guide* for more information on additional screens and screen differences.

Field Types

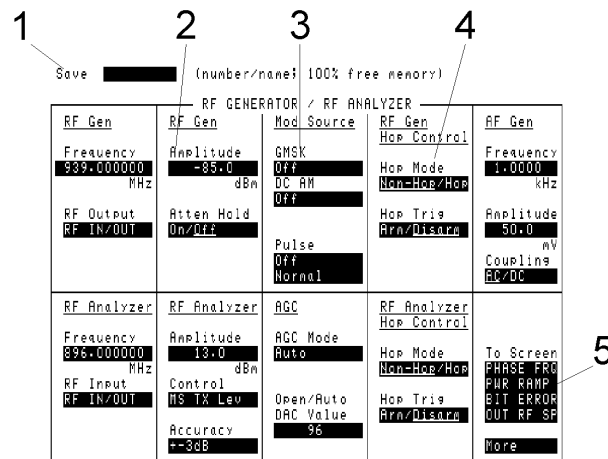

1. Alphanumeric

This field is where you enter names or titles.

To enter, position the cursor next to a character or edit function, then push the knob to select it. (A list of character and function choices appears in the bottom-right corner of the screen.)

2. Data Entry

This field is where you enter numeric values.

To enter a numeric value, position the cursor next to the field and change the value in one of two ways:

- Key in the value using the DATA keys.
- Push the knob and turn to increment or decrement the value. Push the knob again to set the displayed value.

3. List of Choices

This field type allows selection from a list of choices.

To make a selection, position the cursor next to the field and push the knob. A list of choices will appear in the bottom-right corner of the screen. Position the cursor and then push the knob to choose.

- 4. Underlined Entry** This type of field allows selection between the two labels in the field separated by a slash (/).
To toggle between the choices, position the cursor next to the field and push the knob. The underlined choice is activated.
- 5. To Screen List** This field allows selection of alternate screens. To change to another screen, position the cursor next to the required screen and push the knob.

Audio

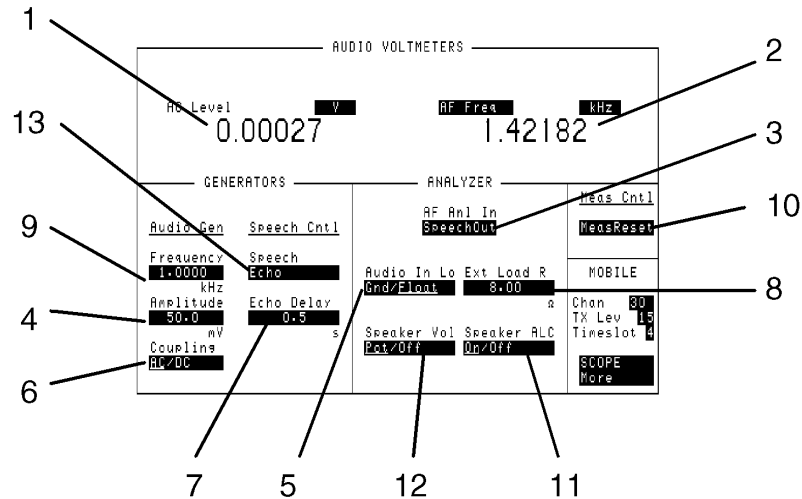

1. AC Level

This field displays the measured ac level of the AF analyzer input (AF Anl In) when Audio Out, Pls Demod, Audio In, Speech In, Speech Out, or Scope In is selected as the input.

See Also Keys: ON/OFF, HI LIMIT, LO LIMIT, REF SET, AVG, METER, Units

2. AF Freq

This field selects the type of measurement to be made on the input signal. The input signal to be measured is selected in the **AF Anl In** field.

Choices

- AF Freq** measures the audio frequency.
- DC Level** measures the dc level.
- Distn** measures the distortion.
- SINAD** measures SINAD.

See Also Keys: ON/OFF, HI LIMIT, LO LIMIT, REF SET, AVG, METER, Units

3. AF Anl In

This field selects the AF analyzer input.

Choices

Scope In selects the SCOPE IN (MEASURE) front-panel connector.

Speech Out selects the signal going to the MON/SPEECH (DEMODULATION OUT) front-panel connector.

AM Mod In selects the IN AM/SPEECH (MODULATION) front-panel connector.

Speech In selects the IN AM/SPEECH (MODULATION) front-panel connector.

FM Demod selects the FM demodulation discriminator.

Pls Demod selects the pulse demodulation detector.

Audio In selects the (AUDIO IN HI) front-panel connector.

Audio Out selects the signal going to the AUDIO OUT front-panel connector.

NOTE The **AM Mod In** and the **Speech In** are not featured in the Agilent 8922S.

- 4. Amplitude** This field is the AF Generator Audio Out amplitude setting.
Range 0.0mV rms to 8.84 V rms.
- 5. Audio In Lo** This field sets the reference for the Audio In Lo BNC connector. The choices are Float or Gnd.
- 6. Coupling** This field selects ac or dc coupling of the AF Generator Audio Out signal.
- 7. Echo Delay** This field sets the echo delay when the Speech field is set to Echo mode.
- 8. Ext Load R** This field sets the AF analyzer external load resistance for displaying AF analyzer measurement results in Watts.
Range 0.1 Ω to 1 M Ω
- 9. Frequency** This field is the AF Generator Audio Out Frequency setting.
Range dc to 30 kHz.

Screens

Audio

**10. Meas Reset
(Meas Cntl)**

Selecting Meas Reset will erase any accumulated measurements used for calculating a final result, and re-start the measurement process for the following functions:

- HI LIMIT
- LO LIMIT
- AVG

This field resets the AF Analyzer measurements.

See Also Keys: HIGH LIMIT, LO LIMIT, AVG

11. Speaker ALC

This field selects the Speaker ALC mode. ON maintains the speaker output at a constant amplitude for audio signals of different levels. OFF allows the audio signal/tone level to determine the speaker output.

NOTE

Speaker ALC is not featured in the Agilent 8922S.

12. Speaker Vol

This field turns the Speaker Volume off or directs control to the front-panel volume control. POT selects front-panel volume control knob. OFF turns the speaker off.

NOTE

Speaker Vol is not featured in the Agilent 8922S.

13. Speech

This field selects the speech mode.

Choices

None

Uncond (unconditioned) activates the MODULATION IN AM/SPEECH connector on the front panel, but the speech signal is not conditioned by filters, and no gain control is provided.

Cond (conditioned) activates the MODULATION IN AM/SPEECH connector on the front panel and conditions speech through filters. Gain control is available in the Speech Gain field.

NOTE

DCAM must be off when Cond is selected. See Screens, RF Generator/RF Analyzer.

To hear the demodulated audio from the mobile station, go to the Audio screen. Under AF Anal In, select SpeechOut. The audio signal will also be available at the Demodulation Out Mon/Speech Out connector.

Echo causes the Agilent 8922M/S to send back the received speech signal to the mobile station. The echo delay is the additional delay the Agilent 8922M/S inserts before sending back speech to a mobile station.

PRBS generates a pseudo random bit sequence which is used for making bit error tests. When selected, a field called PRBS Pattern is displayed (refer to PRBS Pattern field description).

PRBS is selected automatically when Run is selected on the Bit Error Test screen.

NOTE

None, **Uncond**, and **Cond** are not featured in the Agilent 8922S.

Bit Error

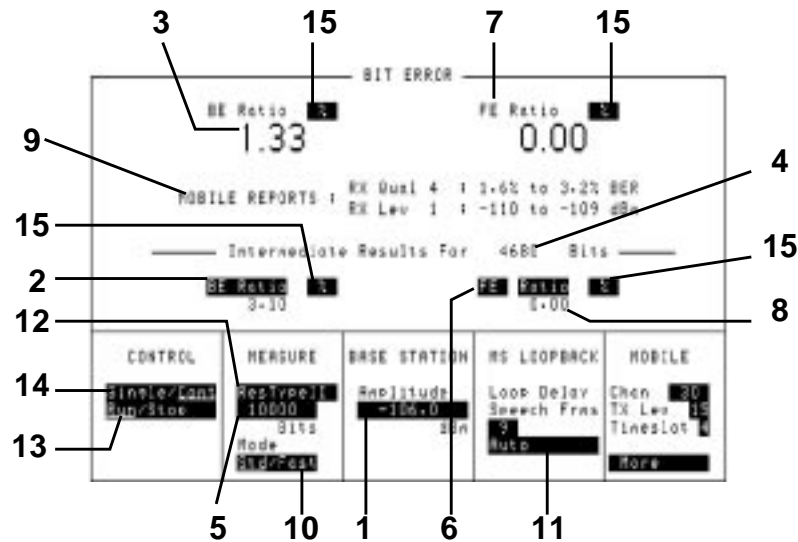

- 1. Amplitude (Base Station)** This field changes the RF generator amplitude. It is a duplicate of the RF generator's Amplitude field on the RF Generator/RF Analyzer screen.
- See Also** Screens: RF Generator/RF Analyzer (RF Generator).
- 2. BE Ratio** This field selects how bit errors will be displayed.
- Choices** **BE Count** displays the total number of bit errors.
BE Ratio calculates and displays the ratio of bit errors counted to the total number of bits measured (depends on measurement type).
- 3. BE Ratio/Count** This field displays the result of the bit error ratio after all the bits have been tested.
- 4. Intermediate Results** This field displays the number of bits that have been tested during a measurement that is currently running. This number includes only bits that are tested by the selected measurement type.

- 5. Bits (Measure)** This field selects the number of bits which will be tested.
This number includes only bits that are tested by the selected measurement type.
- 6. CRC or FE** These fields determine what data will be displayed.
Choices **CRC** displays cyclic-redundancy-check (CRC) errors.
 FE displays frame erasures.
- 7. CRC/FE Ratio** This field displays the result of the CRC or FE ratio after all the bits have been tested.
- 8. Count or Ratio** This field determines how the frame erasures or cyclic-redundancy-check (CRC) errors will be displayed.
Choices **Count** displays the number of frame erasures or cyclic-redundancy-check (CRC) errors.
 Ratio displays the ratio of frame erasures or cyclic-redundancy-check (CRC) errors to total frames.
- 9. Mobile Reports** The mobile reports reflect the status of the signal the mobile is receiving. These are:
 - RX Qual
 - RX Lev
- 10. Mode** This field selects the mode of Bit Error measurement.
Choices **STD** this leaves the display as standard, shown above.
 FAST from the cell control screen, this sends the display to the Fast Bit Error screen when selecting Bit Error.
- 11. MS Loopback** In normal BER mode, the loop delay is the total Round Trip Delay (RTD) of the Agilent 8922M/S and mobile phone, expressed in speech frames. The correct number of TDMA frames can be determined automatically by making a Bit Error Test using Auto Mode when the bit error ratio is approximately <20%. Then, if faster measurements are desired or if the bit error ratio exceeds 20%, change the mode to manual.
Choices **Burst Delay** - range 0 through 15.
 Manual
 Auto
See Also Screens: Bit Error Test (Manual, Auto)

Screens
Bit Error

**12. Res Type
(Measure)**

Residual Type field selects the type of bit error test results to display. (Res means residual).

Choices

- TypeIa**
- ResTypeIa**
- TypeIB**
- ResTypeIB**
- TypeII**
- ResTypeII**
- TypeI**
- ResTypeI**
- AllFS**
- ResAllFS**
- Off**

**13. Run/Stop
(Control)**

Run starts a bit error test. Stop discontinues the bit error test in progress.

**14. Single/Cont
(Control)**

Single allows one test to be performed. Cont allows testing to automatically repeat.

**15. % (BE Ratio and
CRC/FE Ratio)**

This field allows you to select between a display showing the percentage of errors (select **MHz**) and ppm (select **W**) which gives you the errors in parts-per-million.

See Also Keys: ON/OFF, LO LIMIT, HI LIMIT, REF SET, AVG, Units

Bit Error 2

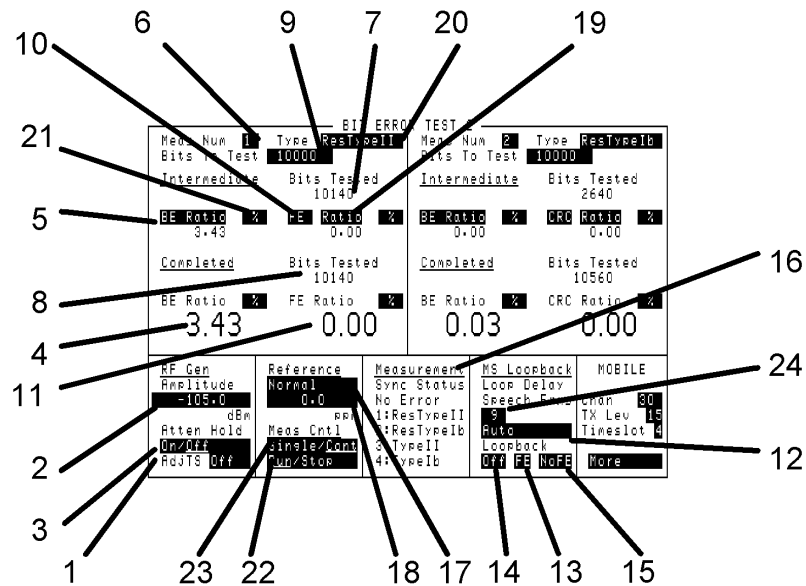

Each time the Bit Error Test is run, four measurements are made (see Meas Num). Because of limited screen space, only two measurements are displayed at one time. The upper left side of the screen will display measurement 1 or 3, and the upper right side will display measurement 2 or 4. For further information, read the field description for Meas Num.

The test results display area is separated into Intermediate results, which are results obtained during a test, and Completed results, which are results from the last completed test.

1. AdjTS

This field selects automatic pulse modulation for the adjacent timeslots.

Choices

+30 dB automatically pulses the adjacent timeslots 30 dB higher than the RF generator amplitude setting.

The entire preceding timeslot is 30 dB higher. The first few bits for the following timeslot are 30 dB higher. The remainder of the following timeslot is pulsed off.

Off makes all timeslots the same amplitude.

Screens
Bit Error 2

NOTE This field is not featured in the Agilent 8922S.

2. Amplitude This field changes the RF generator amplitude. It is a duplicate of the RF generator's Amplitude field on the RF Generator/RF Analyzer screen.

See Also Screens: RF Generator/RF Analyzer (RF Generator).

3. Atten Hold This field turns the attenuator hold on or off.

4/5. BE Ratio/BE Count These fields select how bit errors will be displayed for both the Intermediate and Completed results.

Choices **Bit Error** displays the bit errors/count per measurement.
Bit Count calculates and displays the ratio of bit errors counted to the total number of bits measured (depends on measurement type).

Field (4) displays the final result of the measurement, field (5) displays a running total of the bit errors.

6. Meas Num Use this field to define and display measurements 1 or 3. The right side of the screen allows access to measurements 2 or 4. Refer to 16 for further information.

7. Bits Tested (Intermediate) This field displays the number of bits that have been tested during a measurement that is currently running. This number includes only bits that are tested by the selected measurement type.

8. Bits Tested (Completed) This field displays the number of bits that were tested during the last fully completed test.

Bit error tests may extend beyond the number entered in the "Bits To Test" field so that the last speech frame may be completed.

9. Bits To Test This field selects the number of bits which will be tested. This number includes only bits that are tested by the selected measurement type.

10. CRC or FE These fields determine what data will be displayed.

Choices **CRC** displays cyclic-redundancy-check (CRC) errors.
FE displays frame erasures.

See Also Keys: ON/OFF, LO LIMIT, HI LIMIT, REF SET, AVG, Units

- 11/19. Ratio/Count** These fields select how frame errors/CRC errors will be displayed for both the Intermediate and Completed results.
- Choices** **Error** displays the frame errors/CRC as a percentage per measurement.
 Count calculates and displays the total number of bit errors counted to the total number of bits measured (depends on measurement type).
- Field (11) displays the final result of the measurement, field (19) displays a running total of the bit errors.
- 12. Auto** This field sets the loop delay automatically whenever a bit error test is started.
- 13/14/15. Loopback** These fields select the loopback mode for the mobile station. When one of these fields is selected, the Agilent 8922M/S will attempt to put the mobile station in the described loopback mode. The mobile station must be on a traffic channel to receive the loopback message.
- Choices** **Off** turns loopback mode off.
 No FE sets loopback mode and turns off frame erasure.
 FE selects loopback mode and turns on frame erasure.
- See Also** Screens: Cell Control
- 16. Measurement 1-4** These fields display a summary of the measurement Type definitions for all measurements 1 through 4. To change these fields, use the Meas Num (6) and Type fields. The Sync Status field displays any errors that occurred while trying to synchronize to the midamble of demodulated data.
- **Bad Sync** appears when the expected midamble bit pattern cannot be found in the demodulated burst.
Possible causes of Bad Syncs are:
 - Power was too low.
 - Demodulation trigger too early or too late.
 - FM (bit) errors found while synchronizing to desired midamble.
 - RF overload (increase RF Analyzer Amplitude setting).
 - **No Error** appears when no synchronization error occurred.
- 17. Normal (Reference)** This field allows you to set a normal or a tunable reference.
- See Also** Screens: Configure

Screens
Bit Error 2

18. 0.0 (Reference) This field is used to adjust the reference offset when using the tunable reference.

19. Count or Ratio This field determines how the frame erasures or cyclic-redundancy-check (CRC) errors will be displayed.

Choices **Count** displays the number of frame erasures or cyclic-redundancy-check (CRC) errors.
Ratio displays the ratio of frame erasures or cyclic-redundancy-check (CRC) errors to total frames.

Type This field selects the type of bit error test results to display. (Res means residual).

Choices **TypeIa**
ResTypeIa
TypeIB
ResTypeIB
TypeII
ResTypeII
TypeI
ResTypeI
AllFS
ResAllFS
Off

NOTE Intermediate results for measurement type “Off” will return zeros.

21. %, ppm (BE ratios) These fields select the units (ppm or %) for BE Ratios, FE, or CRC ratios. When Count is selected, these fields are blank.

See also Keys: ON/OFF, HI LIMIT, LO LIMIT, REF SET

22. Run/Stop (Meas Cntl) Run starts a bit error test. The Speech field in the Cell Control screen will automatically be set to PRBS. Digital Demod will automatically be armed if it was disarmed.

Stop discontinues the bit error test in progress.

23. Single/Cont (Meas Cntl) Single allows one test to be performed. Cont allows testing to automatically repeat.

24. MS Loopback This field is used to enter or display amount of delay (expressed in number of speech frames), before bits are compared. The Agilent 8922 uses this value to synchronize to the correct received PRBS speech frame. The correct number of speech frames can be determined automatically by making a Bit Error Test using Auto Mode when the bit error ratio is approximately <20%. Then, if faster measurements are desired or if the bit error ratio exceeds 20%, change the mode to manual.

See Also Screens: Bit Error Test (Manual, Auto)

23. Bits Tested (Completed) This field displays the number of bits that were tested during the last fully completed test.

Bit error tests may extend beyond the number entered in the “Bits To Test” field so that the last speech frame may be completed.

Cell Configuration - GSM 900

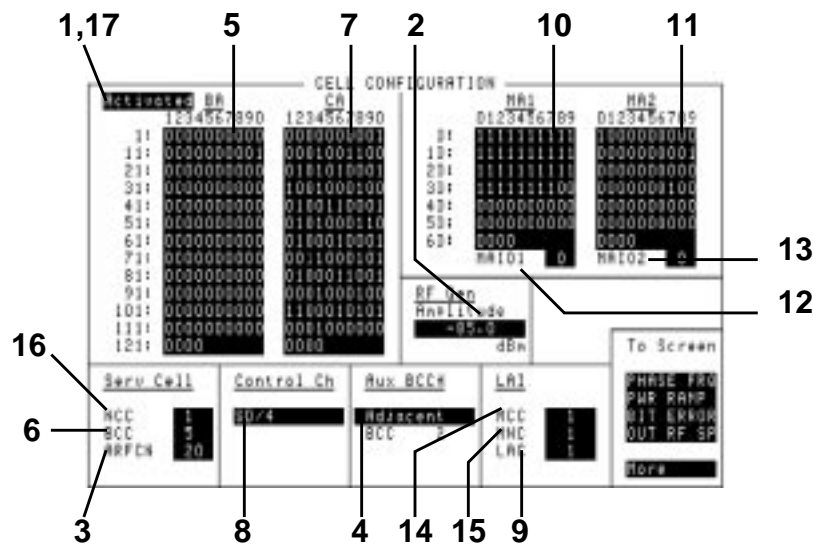

Activated

When Activated is displayed, the Agilent 8922M/S is operating as a base station simulator, and calls can be attempted.

Most settings affecting cell configuration are not settable (cannot be changed) while Activated.

Choices

Activated means that most of the Cell Configuration screen's settings are in use (activated) and cannot be changed. RF Generator, Serv Cell, Aux BCCH, and LAI screen settings can be changed.

Settable means that most of the settings on this screen can be set.

When the Agilent 8922M/S operating state is changed from Settable to Activated, some fields are automatically changed or overwritten. Use the following table to locate the fields that might affect your setup.

| Field | State |
|---------------------------------------|--------------------------|
| RF Gen, Hop Trig | Arm |
| RF Anl, Hop Trig | check setting |
| Hop Address, Address Source | Seq |
| RF Gen, Settling | Normal |
| RF Analyzer, Settling | Normal |
| RF Gen, Hop Mode | Hop |
| RF Analyzer, Hop Mode | check setting |
| RF Analyzer, Hop Frequencies Address | 0 |
| RF Generator, Hop Frequencies Address | 0 |
| Hop Address | 0 |
| Hop Address Next | check setting |
| Burst Num 0 Burst Type | Depends on Serv Cell BCC |
| Burst Num 1 Burst Type | RACH |
| Burst Num 2 Burst Type | Depends on Serv Cell BCC |
| Burst Num 3 Burst Type | RACH |
| Burst Num 0 Trig Qual | RF Power |
| Burst Num 1 Trig Qual | RF Power |
| Burst Num 2 Trig Qual | Normal |
| Burst Num 3 Trig Qual | Normal |
| Demod Sync, Burst Sel | Ext |
| Demod Trig, Trig Source | Ext Demod |
| Demod Arm, State | Arm |
| Meas Sync, Sync Mode | Midamble |
| Meas Sync, Burst Sel | Ext |

See Also Screens: Cell Configuration (**Settable**)

2. Amplitude

This field changes the RF generator amplitude. It is a duplicate of the RF Gen Amplitude field on the RF Generator/RF Analyzer screen.

See Also Screens: RF Generator/RF Analyzer (RF Generator).

3. ARFCN

This field sets the absolute RF channel number for the serving cell Broadcast Channel.

Screens
Cell Configuration - GSM 900

4. Aux BCCH This field allows selection of data and clock outputs.

NOTE This is not featured in the Agilent 8922S.

Choices **Off** causes the front-panel MODULATION IN/OUT DATA and CLOCK connectors to be inputs.
Adjacent causes data and clock signals to be output on the front-panel MODULATION IN/OUT DATA and CLOCK connectors. These signals can be connected to a 0.3 GMSK generator (HP/Agilent 8657A/B Option 022.) A mobile station should be able to camp on to the Aux BCCH.

The BCC (Base Station Colour Code) is displayed in this field and has a number plus 1 modulo 4 relationship with Serv Cell BCC.

NOTE The data output includes a midamble, which will result in discrete sidebands. If random data is desired, use an HP/Agilent 8904A Option 001 or 002 to generate random data and clock signals to the 0.3 GMSK generator.

See Also Connectors and Timing Diagrams: CLOCK (MODULATION)
Connectors and Timing Diagrams: IN/OUT DATA (MODULATION)

5. BA This field is a 124-element Boolean array defining which ARFCNs are in the base station allocation. The serving cell ARFCN does not have to be set to a 1 in this table.

Choices **Done** exits the choices menu.
Position moves the cursor to the desired position in the array.
0 means the ARFCN is not selected.
1 means the ARFCN is selected.

6. BCC This field sets the base-station color-code portion of the BSIC (base station identity code) for the serving cell.

Range 0 through 7

7. CA This field is a 124-element Boolean array defining which ARFCNs are in the cell allocation table. It is used to define the ARFCNs used in the TCH hop sequence.

Choices **Done** exits the choices menu.
Position moves the cursor to the desired position in the array.
0 means the ARFCN is not selected.
1 means the ARFCN is selected.

- 8. Control Ch** This field selects the control channel organization.
- Choices**
- SD/4** selects a broadcast channel with a BCCH + CCCH + SDCCH/4 channel organization. The broadcast channel will be on the physical channel defined under the Serv Cell ARFCN field, timeslot 0.
 - SD/8** selects a broadcast channel with a BCCH + CCCH organization. The SDCCH/8 control channel is defined by the following 2 fields.
 - SDCCH/8 ARFCN
 - SDCCH/8 Timeslot
 - FA** (fast associated) sets the control channel to use stolen FACCH frames on the TCH selected on the Cell Control screen. When this choice is made, the BCH will have a BCCH + CCCH channel organization. All call signaling is done on FACCH channels on the TCH.
 - SD/4FA** selects a BCCH + CCCH + 4 SDCCH/4 broadcast channel. All call signaling is done on FACCH channels on the TCH.
- 9. LAC** This field is the location-area-code (LAC) portion of the location area identity (LAI).
- Range** 0 through 65535
- 10. MA1** This field is a 64-element Boolean array that defines which cell- allocation absolute radio frequency channel numbers (CA ARFCNs) will be in mobile allocation number 1 (MA1). MA1 defines which of the first 64 entries of 1s in the CA will be part of the sequential hop sequence for MA1.
- Choices**
- Done** exits the choices menu.
 - Position** moves the cursor to the desired position in the array.
 - 0** does not select an ARFCN from the CA table.
 - 1** selects an ARFCN from the CA table.

- 11. MA2** This field is a 64-element Boolean array that defines which cell- allocation absolute radio frequency channel numbers (CA ARFCNs) will be in mobile allocation number 2 (MA2). MA2 defines which of the first 64 entries of 1s in the CA will be part of the sequential hop sequence for MA2.
- Choices** **Done** exits the choices menu.
 Position moves the cursor to the desired position in the array.
 0 does not select an ARFCN from the CA table.
 1 selects an ARFCN from the CA table.
- 12. MAIO1** This field is the integer mobile-allocation index offset 1 (MAIO1). It offsets the cyclic hop-sequence by the specified number of TDMA frames.
- Range** 0 through 63
- 13. MAIO2** This field is the integer mobile-allocation index offset 2 (MAIO2). It offsets the cyclic hop-sequence by the specified number of TDMA frames.
- Range** 0 through 63
- 14. MCC** This field is the mobile country-code (MCC) portion of the location area identity (LAI).
- Range** 0 through 999
- 15. MNC** This field is the mobile network-code (MNC) portion of the location area identity (LAI).
- Range** 0 through 99
- 16. NCC** This field sets the NCC: PLMN Color Code portion of the base station identity code (BSIC) for the serving cell.
- Range** 0 through 7

17. Settable

This field, when Settable is displayed, indicates that all Cell Configuration settings can be set or modified.

When the Agilent 8922M/S Cell Configuration is changed from Activated to Settable, some fields are automatically changed or overwritten. Use the following table to locate the fields that might affect your setup.

| Field | State |
|----------------------|--------------|
| Demod Arm State | Disarm |
| RF Gen Hop Trig | Disarm |
| RF Anl Hop Trig | Disarm |
| RF Gen Hop Mode | Non-Hop |
| RF Analyzer Hop Mode | Non-Hop |

Cell Configuration - E-GSM, DCS 1800, PCS 1900

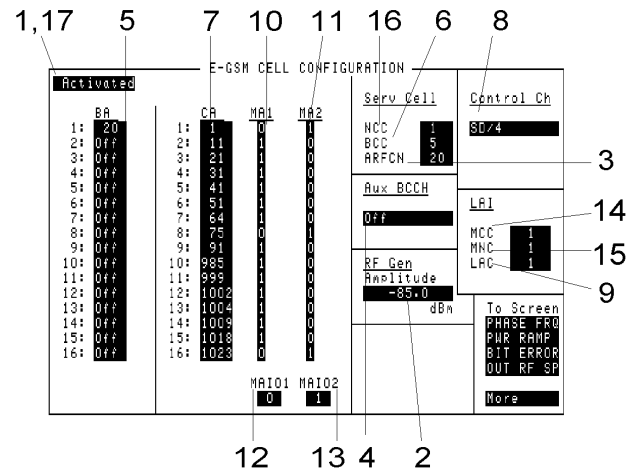

1. Activated

When Activated is displayed, the Agilent 8922M/S is operating as a base station simulator, and calls can be attempted.

Most settings affecting cell configuration are not settable (cannot be changed) while Activated.

Choices

Activated means that most of the Cell Configuration screen's settings are in use (activated) and cannot be changed. RF Generator, Serv Cell, Aux BCCH, and LAI screen settings can be changed.

Settable means that most of the settings on this screen can be set.

When the Agilent 8922M/S operating state is changed from Settable to Activated, some fields are automatically changed or overwritten. Use the following table to locate the fields that might affect your setup.

| Field | State |
|---------------------------------------|--------------------------|
| RF Gen, Hop Trig | Arm |
| RF Anl, Hop Trig | check setting |
| Hop Address, Address Source | Seq |
| RF Gen, Settling | Normal |
| RF Analyzer, Settling | Normal |
| RF Gen, Hop Mode | Hop |
| RF Analyzer, Hop Mode | check setting |
| RF Analyzer, Hop Frequencies Address | 0 |
| RF Generator, Hop Frequencies Address | 0 |
| Hop Address | 0 |
| Hop Address Next | check setting |
| Burst Num 0 Burst Type | Depends on Serv Cell BCC |
| Burst Num 1 Burst Type | RACH |
| Burst Num 2 Burst Type | Depends on Serv Cell BCC |
| Burst Num 3 Burst Type | RACH |
| Burst Num 0 Trig Qual | RF Power |
| Burst Num 1 Trig Qual | RF Power |
| Burst Num 2 Trig Qual | Normal |
| Burst Num 3 Trig Qual | Normal |
| Demod Sync, Burst Sel | Ext |
| Demod Trig, Trig Source | Ext Demod |
| Demod Arm, State | Arm |
| Meas Sync, Sync Mode | Midamble |
| Meas Sync, Burst Sel | Ext |

See Also Screens: Cell Configuration (**Settable**)

2. Amplitude

This field changes the RF generator amplitude. It is a duplicate of the RF Gen Amplitude field on the RF Generator/RF Analyzer screen.

See Also Screens: RF Generator/RF Analyzer (RF Generator).

3. ARFCN

This field sets the absolute RF channel number for the serving cell Broadcast Channel.

4. Aux BCCH This field allows selection of data and clock outputs.

NOTE This is not featured in the Agilent 8922S.

Choices **Off** causes the front-panel MODULATION IN/OUT DATA and CLOCK connectors to be inputs.
Adjacent causes data and clock signals to be output on the front-panel MODULATION IN/OUT DATA and CLOCK connectors. These signals can be connected to a 0.3 GMSK generator (HP/Agilent 8657A/B Option 022.) A mobile station should be able to camp on to the Aux BCCH.

The BCC (Base Station Colour Code) is displayed in this field and has a number plus 1 modulo 4 relationship with Serv Cell BCC.

NOTE The data output includes a midamble, which will result in discrete sidebands. If random data is desired, use an HP/Agilent 8904A Option 001 or 002 to generate random data and clock signals to the 0.3 GMSK generator.

See Also Connectors and Timing Diagrams: CLOCK (MODULATION)
Connectors and Timing Diagrams: IN/OUT DATA (MODULATION)

5. BA This field is list defining which ARFCNs are in the base station allocation. The serving cell ARFCN does not have to be included in this list.

6. BCC This field sets the base-station color-code portion of the BSIC (base station identity code for the serving cell).

Range 0 through 7

7. CA This field is a list defining which ARFCNs are in the cell allocation table. It is used to define the ARFCNs used in the TCH hop sequence.

- 8. Control Ch** This field selects the control channel organization.
- Choices**
- SD/4** selects a broadcast channel with a BCCH + CCCH + SDCCH/4 channel organization. The broadcast channel will be on the physical channel defined under the Serv Cell ARFCN field, timeslot 0.
 - SD/8** selects a broadcast channel with a BCCH + CCCH organization. The SDCCH/8 control channel is defined by the following 2 fields.
 - SDCCH/8 ARFCN
 - SDCCH/8 Timeslot
 - FA** (fast associated) sets the control channel to use stolen FACCH frames on the TCH selected on the Cell Control screen. When this choice is made, the BCH will have a BCCH + CCCH channel organization. All call signaling is done on FACCH channels on the TCH.
 - SD/4FA** selects a BCCH + CCCH + 4 SDCCH/4 broadcast channel. All call signaling is done on FACCH channels on the TCH.
- 9. LAC** This field is the location-area-code (LAC) portion of the location area identity (LAI).
- Range** 0 through 65535
- 10. MA1** This field is a 16-element Boolean array that defines which cell- allocation absolute radio frequency channel numbers (CA ARFCNs) will be in mobile allocation number 1 (MA1).
- Choices**
- Done** exits the choices menu.
 - Position** moves the cursor to the desired position in the array.
 - 0** does not select an ARFCN from the CA table.
 - 1** selects an ARFCN from the CA table.
- 11. MA2** This field is a 16-element Boolean array that defines which cell- allocation absolute radio frequency channel numbers (CA ARFCNs) will be in mobile allocation number 2 (MA2).
- Choices**
- Done** exits the choices menu.
 - Position** moves the cursor to the desired position in the array.
 - 0** does not select an ARFCN from the CA table.
 - 1** selects an ARFCN from the CA table.

Screens

Cell Configuration - E-GSM, DCS 1800, PCS 1900

- 12. MAIO1** This field is the integer mobile-allocation index offset 1 (MAIO1). It offsets the cyclic hop-sequence by the specified number of TDMA frames.
Range 0 through 15
- 13. MAIO2** This field is the integer mobile-allocation index offset 2 (MAIO2). It offsets the cyclic hop-sequence by the specified number of TDMA frames.
Range 0 through 15
- 14. MCC** This field is the mobile country-code (MCC) portion of the location area identity (LAI).
Range 0 through 999
- 15. MNC** This field is the mobile network-code (MNC) portion of the location area identity (LAI).
Range 0 through 99
- 16. NCC** This field sets the NCC: PLMN Color Code portion of the base station identity code (BSIC) for the serving cell.
Range 0 through 7
- 17. Settable** This field, when Settable is displayed, indicates that all Cell Configuration settings can be set or modified.
When the Agilent 8922M/S Cell Configuration is changed from Activated to Settable, some fields are automatically changed or overwritten. Use the following table to locate the fields that might affect your setup.

| Field | State |
|----------------------|--------------|
| Demod Arm State | Disarm |
| RF Gen Hop Trig | Disarm |
| RF Anl Hop Trig | Disarm |
| RF Gen Hop Mode | Non-Hop |
| RF Analyzer Hop Mode | Non-Hop |

Cell Control - Active Cell

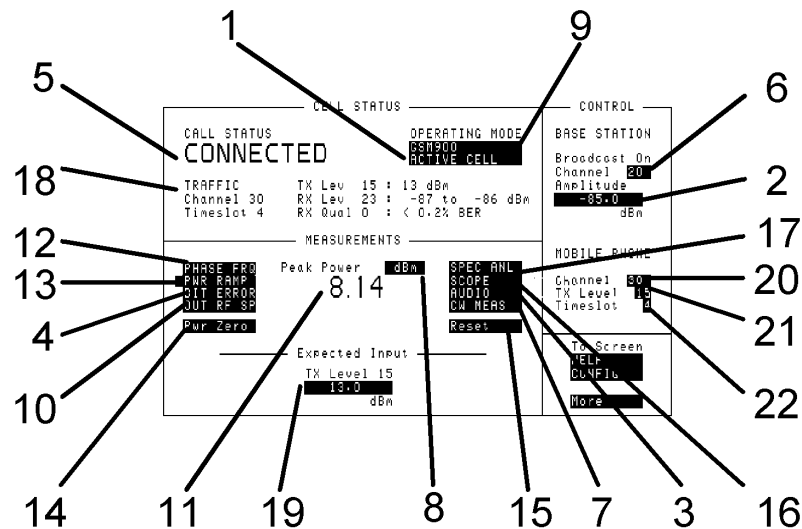

This screens allows you to set up a call with the mobile to be tested and gives you access to the measurement screens.

1. Active Cell TestMode CW Generator

This field selects the operating mode of the Agilent 8922M/S. The modes are:

- Active Cell - this mode allows a call between the mobile phone and the Agilent 8922M/S.
- Test Mode - this mode sets the Agilent 8922M/S to work with a mobile phone running a test mode. This mode allows you to transmit either BCCH only or BCCH and TCH and measures an independent GSM signal.
- CW Generator - this mode sets the Agilent 8922M/S as a signal generator.

2. Amplitude (Base Station)

This field selects what amplitude the Agilent 8922M/S should be transmitting.

See Also Screens: RF Generator/RF Analyzer (RF Generator)

3. Audio

This field displays the audio measurements screen.

Screens

Cell Control - Active Cell

- 4. Bit Error** This field displays the bit error or fast bit error measurements screen depending on which mode has been set in these screens.
See Also Screens: Bit Error or Fast Bit Error
- 5. Call Status** This field displays the status of the communication between the mobile phone and the Agilent 8922M/S. For the active cell, the states are:
- Inactive
 - Proceeding
 - Alerting
 - Connected
- 6. Channel (Base Station)** This field selects which channel the Agilent 8922M/S transmits the Broadcast Channel (BCCH) information. If this is changed during a call, the call will be deactivated.
- 7. CW Meas** This field displays the CW measurements screen.
- 8. dBm** This field displays the units of the Peak Power measurement.
See Also Keys: ON/OFF, HI LIMIT, LO LIMIT, REF SET, AVG, UNITS, METER
- 9. GSM900/E-GSM/DCS1800/PCS1900** This field selects the type of mobile that is to be tested.
Choices GSM 900
E-GSM
DCS 1800
PCS 1900
- 10. Out RF SP** This field displays the output RF spectrum measurements screen.
- 11. Peak Power** This field displays the measured peak carrier power.
-
- NOTE** The measurement display will *not* update if there is no signal to measure. This includes the case where the expected input level has been set too high.
-
- 12. Phase/Frq** This field displays the phase and frequency measurements screen.

- 13. Pwr Ramp** This field displays the power mask and, (option 006 only), pulse measurements screens.
- 14. Pwr Zero** This field zeros the power meter. RF power must be disconnected from the RF IN/OUT port when executing this function.
- 15. Reset** This field resets all the Agilent 8922M/S's measurements.
- 16. Scope** This field displays the oscilloscope measurements screen.
- 17. Spec Anl (Option 006 only)** This field displays the spectrum analyzer measurements screen.
- 18. Mobile Reports** The mobile reports reflect the status of the signal being received by the mobile phones receiver.
- 19. TX Level/Manual** This field sets the expected input level of the RF Analyzer on the RF IN/OUT port. This level must be within ± 3 dB of the actual level in order that fully calibrated measurements may be made.
- This field displays the amplitude the Agilent 8922M/S is expecting from the mobile phone, and adjusts its RF analyzer setting to match this input. When this field is changed, the mobile phone TX Level and the Agilent 8922M/S RF Analyzer are no longer coupled together. This means that you have independent control of the amplitude of the transmitted mobile phone signal and the sensitivity of the Agilent 8922M/S analyzer circuit.
- When the fields are coupled, the Expected Input shows the power level of the setting. When they are independent, the Expected Level displays **Manual**.
- Range** **GSM900 and E-GSM:** -27.9 to +41.0 dBm.
The fields in the Mobile Phone area display information about the call.
- See Also** Chapter 3: Specifications
- 20. Channel (Mobile)** The channel field allows you to change the channel number of the call, either before or during the call. If this field is changed when a call is in progress, a handover is performed.

Screens

Cell Control - Active Cell

21. TX Level (Mobile)

The TX Level shows the amplitude of the signal to be used by the mobile phone. This can be changed either before or during a call. Changing the value in this field re-couples the mobile phone's output level to the Agilent 8922M/S's Expected Input.

If 0 (zero) is selected then an error message may appear which recommends using an external attenuator.

22. Timeslot (Mobile)

The timeslot field allows you to change the timeslot used for a call within a GSM frame. If this field is changed when a call is in progress, a handover is performed.

Range 2 through 6. 0, 1, and 7 are used for call maintenance.

Cell Control - Active Cell +

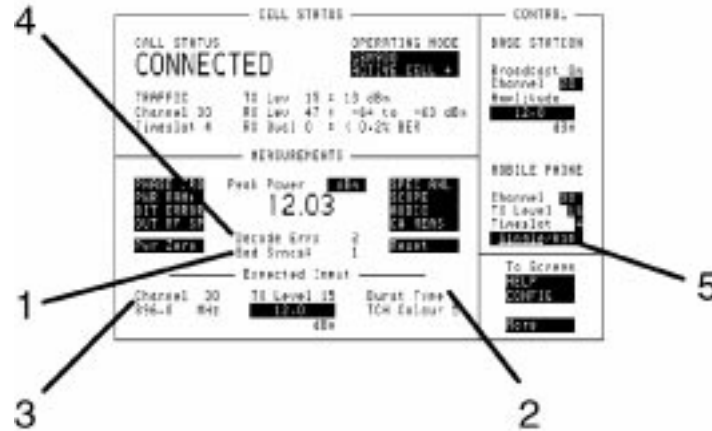

This screen displays all the properties of the Active Cell screen plus five extra fields of information.

1. Bad Syncs

This field is a count of bad synchronization occurrences since the last reset.

See Also Cell Control 2

2. Burst Type

This field indicates the burst type Random Access Channel (RACH) or the Traffic Channel (TCH) and Colour Code of the expected signal.

3. Channel

This field displays the channel number the Agilent 8922M/S is taking measurements from. For a GSM900 mobile phone the channel number may vary from 1 through 124. For an E-GSM mobile phone the channel number may vary from 0 through 124 and 975 through 1023. If you change the channel number, the frequency field value also changes. The converse of this is not the case. You may enter a non GSM standard frequency on another screen, this value must be between 10 MHz to 1000 MHz.

4. Decode Errs

This field indicates the number of decode errors since the last Reset.

See Also Cell Control 2

Screens

Cell Control - Active Cell +

5. Single/Hop

This field selects whether communication between the Agilent 8922M/S and the mobile phone will be on one channel only or hopping across channels. The channels it will hop across is defined on the Cell Config screen. The channel field displays MA1 or MA2. The Cell Config screen displays the channels to be included in hopping in the MA1 and MA2 areas.

See Also Cell Config, MA1/MA2

Cell Control - Test Mode

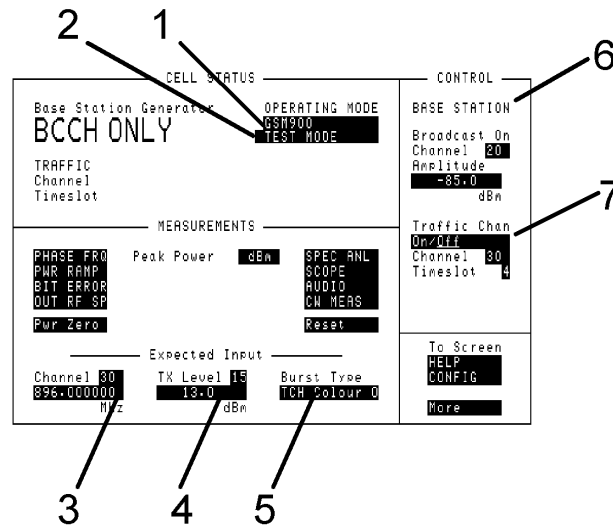

This screens allows you to test the mobile phone without a call being set up.

1. **GSM900**
E-GSM
DCS1800
PCS1900

This field selects the type of mobile that is to be tested.

Choices **GSM 900**
 E-GSM
 DCS 1800
 PCS 1900

2. **Active**
Cell/TestMode/C
W Generator

This field selects the test mode of the Agilent 8922M/S. The types are:

- Active Cell - this mode sets up a call between the mobile phone and the Agilent 8922M/S.
- Test Mode - this mode sets the Agilent 8922M/S to work with a mobile phone running a test mode. This mode allows you to transmit either BCCH only or BCCH and TCH and measures an independent GSM signal.
- CW Generator - this mode sets the Agilent 8922M/S as a signal generator.

- 3. Channel** This field displays the channel number the Agilent 8922M/S is taking measurements from. For a GSM900 mobile phone the channel number may vary from 1 through 124. For an E-GSM mobile phone the channel number may vary from 0 through 124 and 975 through 1023. If you change the channel number, the frequency field value also changes. The converse of this is not the case. You may enter a non GSM standard channel frequency on another screen, between 10 MHz and 1000 MHz.
- 4. TX Lev** This field displays the expected amplitude transmitted by the mobile phone. The fields display this information as a power level and as a dBm value. If you alter the dBm field, the power level shown will not correspond to the channel in amplitude.
- 5. Burst Type.** This field defines the expected burst type of the mobile phone's transmitted bursts. When the Traffic Channel (TCH) is selected, the correct Colour Code should be chosen.
- 6. Base Station** There are two Base Station fields. The Amplitude field sets the amplitude of the Agilent 8922M/S transmission. The Channel field selects which channel the Agilent 8922M/S transmits the Broadcast Control Channel (BCCH) information. If this is changed during a call, the call will be deactivated.
- 7. Traffic Chan** There are three traffic channel fields. The Traffic Chan (On/Off) field toggles the traffic channel. The Channel number allows you to set the traffic channel to any channel number between 1 through 124 for GSM900. The Timeslot allows you select a timeslot from 2 through 6. For an E-GSM mobile phone the channel number may vary from 0 through 124 and 975 through 1023. If you change the channel number, the frequency field value also changes. The converse of this is not the case. You may enter a non GSM standard channel frequency on another screen, between 10 MHz and 1000 MHz.

Cell Control - CW Generator

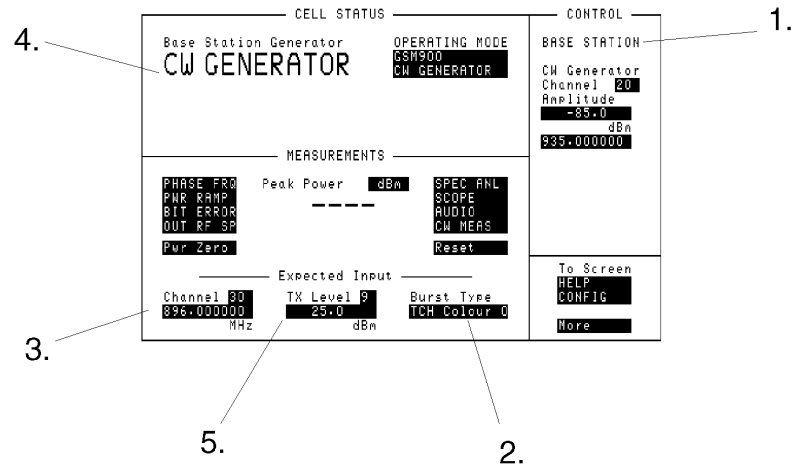

This screens allows you to set the Agilent 8922M/S up as a CW Signal Generator.

1. Base Station

There are two Base Station fields. The Amplitude field sets the amplitude of the Agilent 8922M/S transmission. The Channel field selects which channel the Agilent 8922M/S transmits the Broadcast Control Channel (BCCH) information. If this is changed during a call, the call will be deactivated. The frequency can also be set explicitly between 10 MHz and 1000 MHz.

2. Burst Type.

This field defines the expected burst type of the mobile phone's transmitted bursts. When the Traffic Channel (TCH) is selected, the correct Colour Code should be chosen.

3. Channel

This field displays the channel number the Agilent 8922M/S is taking measurements from. For a GSM900 mobile phone the channel number may vary from 1 through 124. For an E-GSM mobile phone the channel number may vary from 0 through 124 and 975 through 1023. If you change the channel number, the frequency field value also changes. The converse of this is not the case. You may enter a non GSM standard channel frequency on another screen, between 10 MHz and 1000 MHz.

Screens

Cell Control - CW Generator

4. Active Cell TestMode CW Generator

This field selects the test mode of the Agilent 8922M/S. The types are:

- Active Cell - this mode sets up a call between the mobile phone and the Agilent 8922M/S.
- Test Mode - this mode sets the Agilent 8922M/S to work with a mobile phone running a test mode. This mode allows you to transmit either BCCH only or BCCH and TCH and measures an independent GSM signal.
- CW Generator - this mode sets the Agilent 8922M/S as a signal generator.

5. TX Lev

This field displays the expected amplitude transmitted by the mobile phone. The fields display this information as a power level and as a dBm value. The range for the power class is from 0 through 19. If you alter the dBm field, the power level shown will not correspond to the channel in amplitude.

Cell Control 2

The screenshot shows the 'CELL CONTROL 2' screen with the following fields and callouts:

- 6**: Call Status: CW Generator
- 8**: Call Counts
- 5**: Caller:-- RR:None Ciph:off
- 4**: Decode Errs: (points to Decode Errs: 0)
- 1**: Adj Cell: 1 (points to Adj Cell: 1)
- 3**: ARFCN (points to ARFCN: 30)
- 7**: Call Status (points to Call Status: CW Generator)
- 2**: RF Gen Amplitude (points to RF Gen Amplitude: -85.0)

Other visible fields include: MM: Inactive, Pages: 0, RACHs: 0, Bad Syncs: 0, SACCH Meas, TX Lev, RX Lev, RX Qual, Partial, RX Lev, RX Qual, Adj Cell, BSIC, NCC, ARFCN, BCC, Demod Arn, TCH Parms, Mode, ARFCN, Tineslot, Type, Relative MS, Timing Err, MS Parms, Timing Adv, Auto, Audio Cntl, Loopback, DAI, Norm, Test, MS Cntl, DTX On/Off, DRX On/Off, Echo Delay, To Screen, PHASE FRQ, PWR RAMP, BIT ERROR, OUT RF SP, More.

1. Adj Cell

This field selects which adjacent cell SACCH measurement result to display. The adjacent cells are prioritized by power level. One is the largest signal.

Range 1 to 6

2. Amplitude

This field changes the RF generator amplitude. It is a duplicate of the RF generator Amplitude field on the RF Generator/RF Analyzer screen.

See Also Screens: RF Generator/RF Analyzer (RF Generator).

3. ARFCN

This field selects the ARFCN for TCH1 or TCH2 when the Mode field is set to Single.

Other Settings MA1 or MA2 appears in this field when Mode is set to Hopped.

4. Bad Syncs

This field is a count of bad synchronization occurrences since the last reset.

Screens
Cell Control 2

- 5. Caller** This field indicates who initiated the current call.
- **MS** indicates mobile station initiation.
 - **BS** indicates base station initiation.
 - — indicates status call status is inactive.
- 6. Call Status** This field indicates the state of the current call.
- Inactive
 - Setup Request
 - Alerting
 - Connected
 - Disconnect
 - Proceeding
- 7. Call Status TCH State** These fields give information about the current TCH. (If the Agilent 8922M/S is not on a TCH yet, these will be blank.)
- Mode (Hopped or Single)
 - ARFCN (this will be an integer if TCH Mode is single, otherwise MA1 or MA2)
 - Timeslot
- 8. Ciph:** This field displays the current Cipherring mode of the mobile station.

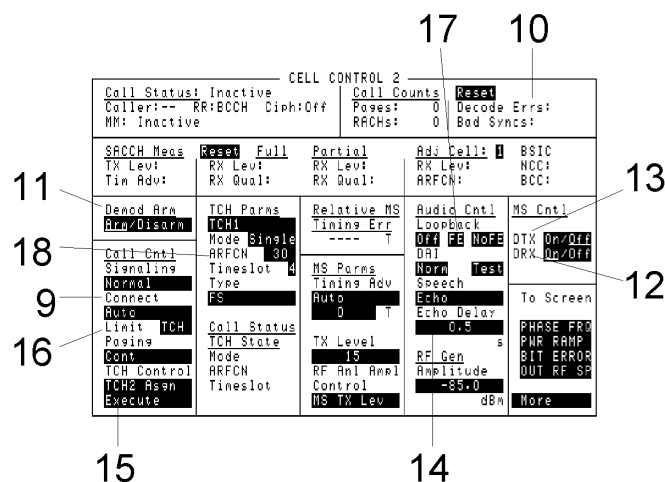

9. Connect

This field selects how an Mobile Station (MS) originated call will be connected.

Choices

Manual connection means that a mobile-initiated call must be answered manually using the **RCV CALL** key.

Auto connection means that a mobile-initiated call will be answered automatically.

10. Decode Errors

This field indicates the number of decode errors since the last Reset.

11. Demod Arm

This field arms or disarms triggering for digital demodulation. It is identical to the Demod Arm State field on the Digital Demod screen.

IMPORTANT

This field is set to Disarm whenever a measurement screen (Output RF Spectrum, Phase/Frequency or Pulse) is accessed. When Demod Arm is disarmed, the Agilent 8922M/S cannot display information about the uplink. When Demod Arm is re-armed, the Cell Control fields that display information about the uplink will resume normal operation.

When Demod Arm is re-armed, measurement results (DSP Analyzer, Output RF Spectrum, Pulse) are lost.

Screens
Cell Control 2

- 12. DRX** This field turns the discontinuous reception (DRX) mode of the mobile station on or off.
- 13. DTX** This field turns the discontinuous transmission (DTX) mode of the mobile station on or off.
- 14. Echo Delay** This field sets the echo delay when the Speech field is set to Echo mode.
- 15. Execute** This field executes the function selected in the TCH Control field.
- 16. Limit** This field selects what signaling state a call will be limited to.
- Choices** **BCCH** is the broadcast channel. The instrument will not respond to RACHs.
DCCH is the dedicated control channel. The instrument will not assign to a TCH.
TCH is the traffic channel. This is the normal operating mode.
- 17. Loopback** These fields select the loopback mode for the mobile station. When one of these fields is selected, the Agilent 8922M/S will attempt to put the mobile station in the described loopback mode.
- Choices** **Off** turns loopback mode off.
No FE turns on loopback with no frame erasure.
FE turns on loopback with frame erasure.
- 18. MA1, MA2** This field selects which MA table on the Cell Config screen will be used by the TCH selected when the Mode field is set to Hopped.
- Choices** **MA1** selects the MA1 table for frequency hopping.
MA2 selects the MA2 table for frequency hopping.
- Other Settings** ARFCN appears in this field when Mode is set to Single.

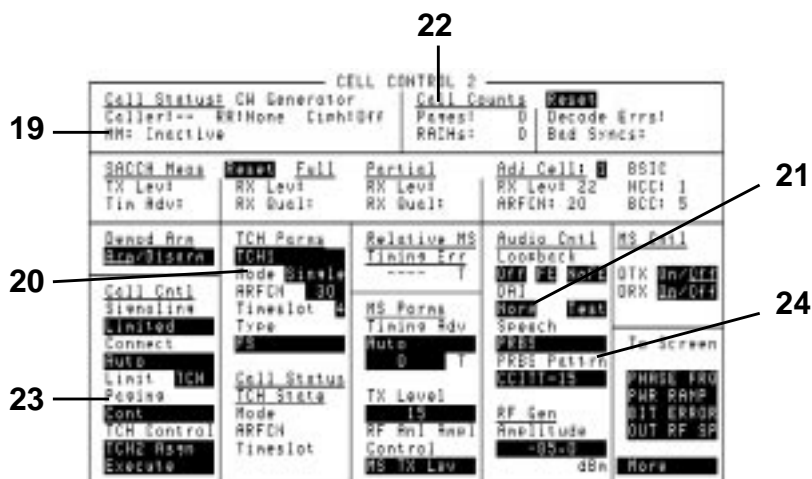

19. MM This field displays the latest events from the Mobility Management sublayer.

- **Loc Upd**
- **Ident**
- **Auth**
- **TMSI**
- **Inactive**
- **Active**

20. Mode This field selects the mode for the traffic control channel selected in the TCH Params field.

Choices **Single** selects a single ARFCN.
Hopped selects a hopped traffic control channel using an MA table.

See Also Screens: Cell Config (**MA1**) Screens: Cell Config (**MA2**)

21. Norm This field uses the digital-audio interface (DAI) to select the normal operating mode for the mobile station.

NOTE This field is not featured in the Agilent 8922S.

22. Pages This field indicates the number of calls (pages) made to the mobile since the last Reset.

23. Paging This field selects the paging mode.

Choices **Single** pages just once when attempting to make a call.
 Cont pages continuously until a connection is made.

24. PRBS Pattn This field allows you to choose from 6 different bit patterns. The Agilent 8922M/S will send the selected sequence to a mobile station. The mobile station must be in loopback mode (see Loopback field description) to return the bit sequence for bit error testing.

This field is displayed only when PRBS is selected in the Speech field.

Choices **CCITT-15** ($2^{15} - 1$ bit pseudo-random pattern, see CCITT Rec. 0.151)
 CCITT-23 ($2^{23} - 1$ bit pseudo-random pattern, see CCITT Rec. 0.151)
 0 (all zeros)
 1 (all ones)
 01 (alternating 0,1)
 10 (alternating 1,0)

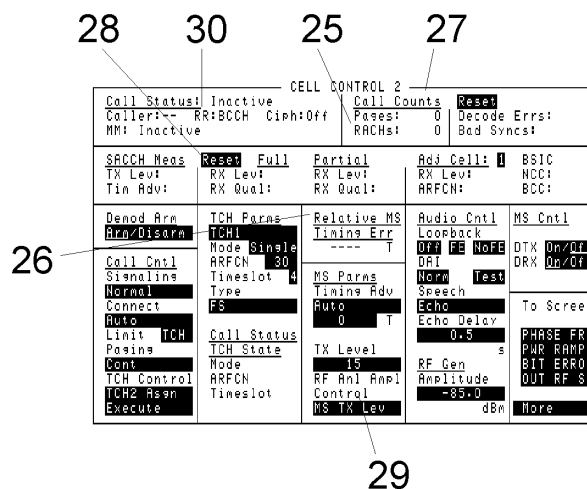

25. RACHs This field indicates the number of RACHs received during the current call or since the last Reset.

26. Relative MS Timing Err This field displays the length of time between when the Agilent 8922M/S expected the uplink burst to arrive and the time it actually arrived.

Timing error measurements on the uplink burst are made from the center of bit 0, and are relative to the default trigger delay value of 473.4 T (see Measurement Sync, Trigger Delay).

The Agilent 8922M/S normally expects the uplink burst 468.75 bit periods after the beginning of the downlink burst. The trigger delay's default value of 473.4 T reflects an additional Agilent 8922M/S delay of 4.65 T (468.75 + 4.65 = 473.4 T).

The accuracy of this measurement is ± 0.25 T. For more accurate measurements, refer to DSP Analyzer, Data Bits, First Bit.

See Also Screens: Phase/Freq: Data Bits (**First Bit**)

27. Reset (Call Counts) This field clears out the counts of pages, RACHs, synchronization, and decode errors detected.

28. Reset (SACCH Meas) This field clears-out all of the SACCH measurements.

Screens

Cell Control 2

29. RF Anl Ampl Control

This field selects control of the RF analyzer's amplitude setting field.

- Choices**
- MS TX Lev** automatically sets the RF analyzer's amplitude setting based on the TX Level field.
 - Manual** requires manual setting of the RF analyzer's amplitude.

30. RR

This field displays the currently established logical channel as indicated by the Radio Resource sublayer.

- **BCCH** indicates that a broadcast channel is being transmitted, and the Agilent 8922M/S is ready to receive a RACH.
- **DCCH** indicates that a control channel is established. The physical channel organization depends on the Control Channel setting (see Cell Configuration screen).
- **TCH1** indicates that a traffic channel is established using the parameters from a TCH1 setup (see TCH Params, Cell Control screen).
- **TCH2** indicates that a traffic channel is established using the parameters from a TCH2 setup (see TCH Params, Cell Control screen).
- **None** is displayed when the instrument mode is Settable (see Cell Configuration screen).

| CELL CONTROL 2 | | | | |
|----------------------------|------------|-------------|-------------|------------------|
| Call Status: Inactive | | Call Counts | | Reset |
| Caller:-- RR:BCCH Ciph:Off | | Pages: 0 | | Decode Errs: |
| MM: Inactive | | RACHs: 0 | | Bad Syncs: |
| 31 | SACCH Meas | Resev: Full | Partial | Adj Cell: 1 BSIC |
| | TX Lev: | RX Lev: | RX Lev: | RX Lev: HCC: |
| | Tim Adv: | RX Qual: | RX Qual: | ARFCN: BCC: |
| 32 | Denod Arn | TCH Parns | Relative MS | Audio Cntl |
| | Arq/Disarn | TCH1 | Timing Err | Loopback |
| | Call Cntl | Mode Single | ---- T | Off FE NoFE |
| | Signalins | ARFCN 30 | | DAI |
| | Normal | Timeslot 4 | MS Parns | Norm Test |
| | Connect | Type | Timing Adv | Speech |
| | Auto | FS | Auto | Echo |
| | Limit TCH | Call Status | 0 T | Echo Delay |
| | Posing | TCH State | TX Level | 0.5 s |
| | Cont | Node | 15 | RF Gen |
| TCH Control | ARFCN | RF Anl Anpl | Amplitude | |
| TCH2 Asen | Timeslot | Control | -83.0 | |
| Execute | | MS TX Lev | dBm | |
| | | | To Screen | |
| | | | PHASE FRQ | |
| | | | PWR RAMP | |
| | | | BIT ERROR | |
| | | | OUT RF SP | |
| | | | More | |
| | | | 33 | |

31. SACCH Meas

These fields indicate the measurement results of a slow associated control channel measurement.

- **TX Lev** indicates the mobile station's reported transmitter power level.
- **Tim Adv** is the mobile station's reported timing advance.
- **Full RX Lev** is the mobile station's received level of power from the serving cell using the Full measurement method.
- **Full RX Qual** is the mobile station's received quality of signal from the serving cell using the Full measurement method.
- **Partial RX Lev** is the mobile station's level of power from the serving cell using the Partial measurement method.
- **Partial RX Qual** is the mobile station's received quality of signal from the serving cell using the Partial measurement method.
- **Adj Cell RX Lev** is the reported level of power of the adjacent cell selected in the Adj Cell field.
- **Adj Cell ARFCN** is the absolute radio frequency channel number of the adjacent cell selected in the Adj Cell field.
- **BSIC NCC** reads the NCC: PLMN Colour-Code portion of the base station identity code (BSIC) of the adjacent cell selected in the Adj Cell field.
- **BSIC BCC** reads the BCC: Base Station Colour-Code portion of the base station identity code (BSIC) of the adjacent cell selected in the Adj Cell field.

Screens
Cell Control 2

32. Signaling **Choices** **Normal** will cause the call to follow the normal GSM recommended signaling sequences.
Limited will eliminate normal call signaling and force an immediate transition to the final channel configuration permitted by the Limit field.

33. Speech This field selects the speech mode.
Choices **None**
Uncond (unconditioned) activates the MODULATION IN AM/SPEECH connector on the front panel, but the speech signal is not conditioned by filters, and no gain control is provided.
Cond (conditioned) activates the MODULATION IN AM/SPEECH connector on the front panel and conditions speech through filters. Gain control is available in the Speech Gain field.

NOTE DCAM must be off when Cond is selected. See Screens, RF Generator/RF Analyzer.

NOTE **None**, **Uncond**, and **Cond** are not featured in the Agilent 8922S.

To hear the demodulated audio from the mobile station, go to the Audio screen. Under AF Anal In, select SpeechOut. The audio signal will also be available at the Demodulation Out Mon/Speech Out connector.

Echo causes the Agilent 8922M/S to send back the received speech signal to the mobile station. The echo delay is the additional delay the Agilent 8922M/S inserts before sending back speech to a mobile station.

PRBS generates a pseudo random bit sequence which is used for making bit error tests. When selected, a field called PRBS Pattn is displayed (refer to PRBS Pattern field description).

PRBS is selected automatically when Run is selected on the Bit Error Test screen.

| CELL CONTROL 2 | | | | |
|----------------------------|-------------|-------------|--------------|------------------|
| Call Status: Connected | | Call Counts | | Reset |
| Caller:MS RR:TCH1 Ciph:Off | | Pases: 0 | Decode Errs: | |
| MM: Active | | RACHs: 2 | Bad Syncs: | |
| 36 | SACCH Meas | Reset Full | Partial | Adj Cell: 1 BSIC |
| | TX Lev: 15 | RX Lev: 8 | RX Lev: 8 | RX Lev: 8 NCC: 1 |
| | Tm Adv: 0 | RX Qual: 1 | RX Qual: 1 | ARFCN: 20 BCC: 5 |
| 38 | Demod Arn | TCH Parms | Relative MS | Audio Cntl |
| | Arr/Disarr | TCH1 | Timing Err | Loopback |
| | Call Cntl | Mode Single | -0.25 T | Off FE NoFE |
| | Signaling | ARFCN 30 | | DAI |
| 42 | Connect | Timeslot 4 | MS Parms | Norm Test |
| | Auto | Type | Timing Adv | Speech |
| | Limit TCH | FS | Auto | Cond |
| | Pasng | | 0 T | Speech Gain |
| | Cont | Call Status | | 1.000 |
| 35 | TCH Control | TCH State | TX Level | To Screen |
| | TCH2 Asgn | Mode Single | 15 | PHASE FRQ |
| | Execute | ARFCN 30 | RF Aml Ampl | PWR RAMP |
| | | Timeslot 4 | Control | BIT ERROR |
| | | FS | MS TX Lev | OUT RF SP |
| | | | | None |
| | | | | dBm |

34. Speech Gain This field sets the amplification of the Cond speech mode.

NOTE This field is not featured in the Agilent 8922S.

35. TCH Control This field selects traffic-channel control type.

Choices

- TCH1 HO** selects an intercell handover based on the TCH1 parameter selections.
- TCH2 HO** selects an intercell handover based on the TCH2 parameter selections.
- TCH1 Asgn** selects a traffic channel assignment based on the TCH1 parameter selections.
- TCH2 Asgn** selects a traffic channel assignment based on the TCH2 parameter selections.

36. TCH Parms This field selects which traffic channel parameter settings to display.

Choices

- TCH1** displays traffic channel 1 settings.
- TCH2** displays traffic channel 2 settings.

37. Test This field tells the mobile station to select the “Test of acoustic devices and A/D and D/A” mode. This is done over the digital-audio interface (DAI).

Screens
Cell Control 2

- 38. Timeslot** This field selects the timeslot for the traffic channel selected in the TCH Params field.
Range 2 through 6
- 39. Timing Advance (mode)** This field selects the timing advance mode.
Choices **Manual** allows manual setting of the MS timing advance.
When Manual is selected, the mobile station's timing advance can be changed by entering a number in the Timing Advance (number) field. The mobile station's current timing advance, displayed in the SACCH Meas Tim Adv field, should match the Timing Advance number.
Auto automatically calculates and sets MS timing advance.
- 40. Timing Advance (number)** This field sets the MS's timing advance.
Range 0 through 63
- 41. TX Level** This field selects the transmit power level for the mobile station to use.
If 0 (zero) is selected then an error message may appear which recommends using an external attenuator.
Range 0 through 19
- 42. Type** This field selects the traffic channel type for the TCH selected in TCH Params.
Choices **FS** Full rate speech.

Configure

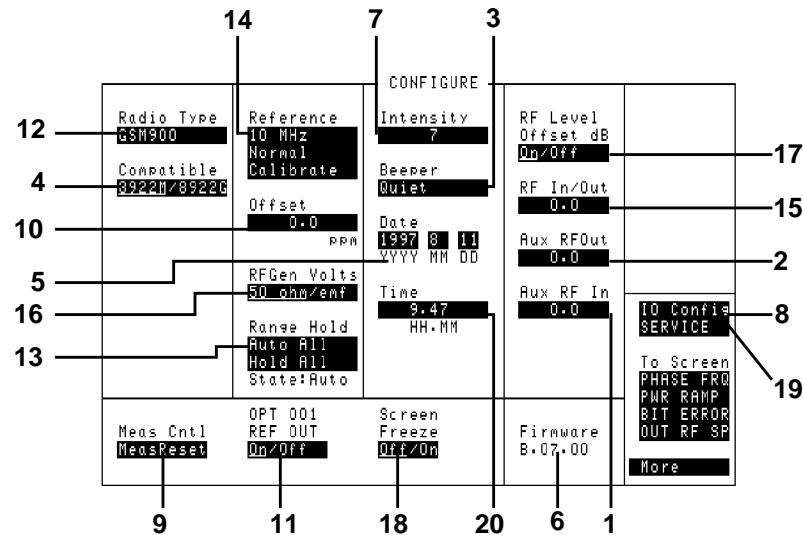

1. Aux RF In

This field is used to indicate losses or gains between the AUX RF IN port and the device under test.

NOTE

This field is only used when the **RF Level Offset** field is set to **On**.

Enter a **positive** value to indicate a gain (such as an amplifier). The Spectrum Analyzer Marker Level (**Lvl**), measurements are automatically reduced. (The Spectrum Analyzer **Ref Level** is automatically decreased, so the trace position does not appear to change.)

Enter a **negative** value to indicate a loss (such as cable loss). The Spectrum Analyzer Marker Level (**Lvl**), measurements are automatically increased. (The Spectrum Analyzer **Ref Level** is automatically increased, so the trace position does not appear to change.)

See Also **RF Level Offset**

2. Aux RF Out

NOTE

This field is only used when the **RF Level Offset** field is set to **On**.

This field is used to indicate losses or gains between the AUX RF OUT port and the device under test.

- Enter a **positive** value to indicate a gain (such as an amplifier gain). The RF Generator level is automatically set to that amount *below* that which is indicated in the RF Generator's **Amplitude** field. (Example; if this value is 10 dB, and the **Amplitude** field shows 0 dBm, the actual level out this port is -10 dBm.) The value at the output of the external amplifier should then be at the level indicated in the **Amplitude** field.
- Enter a **negative** value to indicate a loss (such as cable loss). The RF Generator level is automatically set *above* to that amount which is indicated in the RF Generator's **Amplitude** field to compensate. The value at the opposite end of the cable (loss) should then be at the level indicated in the **Amplitude** field; unless the resulting RF Generator setting exceeds the maximum output level, then an error occurs - **Input value out of range**. In that case, increase the **Aux RF Out** setting, or increase the **Aux RF In** power level so that they are closer to zero.

3. Beeper

This field controls the beeper volume.

Choices **Off**
 Quiet
 Loud

4. Compatible

This toggle field allows you to simulate the operation of an Agilent 8922G (from an Agilent 8922M) or an Agilent 8922E (from an Agilent 8922S). The **PRESET** key can be used to set the correct Preset conditions after this field has been changed, although a power cycle is recommended.

5. Date

These fields set the date for the internal calendar. The Date can be read by a controller using GPIB, then printed on test results (YYYY MM DD).

6. Firmware

This field displays the firmware revision of the instrument.

7. Intensity

This is the CRT intensity adjustment field.

Range 1 to 8.

- 8. I/O Config** This field allows you to access the I/O configuration screen. This screen allows you to select your printer configuration, GPIB and serial port communication settings.
- 9. Meas Reset (Meas Cntl)** Selecting Meas Reset will erase any accumulated measurements used for calculating a final result, and re-start the measurement process for the following functions:
- HI LIMIT
 - LO LIMIT
 - AVG
- 10. Offset** This field sets the reference frequency offset in parts-per-million (ppm).
- 11. OPT 001 REF OUT** If installed, this field turns the optional high stability timebase on or off.
- 12. Radio Type** This field selects the type of radio to be tested.
- Choices** **GSM 900**
 E-GSM
 DCS 1800
 PCS 1900
- 13. Range Hold** This field selects the ranging mode for the AF analyzer and the spectrum analyzer.
- Choices** **Auto All** selects auto ranging.
 Hold All selects range hold, allowing manual setting of spectrum analyzer input attenuation and AF Analyzer gain control.
- See Also** Screens: Spectrum Analyzer (**Input Atten**)

14. Reference

This field selects the external reference frequency that the instrument locks to, and sets the reference tuning mode.

Choices **13 MHz**
 10 MHz
 5 MHz
 2 MHz
 1 MHz

Normal locks the instrument to the external reference frequency selected.

Tunable enables the instrument to adjust its internal frequency reference. Frequency adjustment is relative to an external reference which the internal reference is calibrated to.

Calibrate calibrates the internal reference to the external reference for use in Tunable mode.

15. RF IN/Out

This field is used to indicate losses or gains between the RF IN/OUT port and the device under test.

NOTE

This field is only used when the **RF Level Offset** field is set to **On**.

- Enter a **positive** value to indicate a gain (such as an amplifier gain). When the RF IN/OUT port is used as an output, the RF Generator level is automatically set to that amount *below* which is indicated in the RF Generator's **Amplitude** field. (Example; if this value is 10 dB, and the **Amplitude** field shows 0 dBm, the actual level out this port is -10 dBm.)

When this port is used as an input, the CW Power, Peak TX Power, measurements, and Spectrum Analyzer Marker Level (**Lv1**), are automatically *reduced*.

- Enter a **negative** value to indicate a loss (such as cable loss). The RF Generator level out this port is automatically set to that amount *above* which is indicated in the RF Generator's **Amplitude** field to compensate.

When used as an input, the CW Power, PK TX Power, Fast TX Carrier Power measurements, and Spectrum Analyzer Marker (**Lv1**), are *increased*.

16. RFGGen Volts

This field selects between 50 ohm and emf voltage units for the RF generator amplitude settings.

17. RF Level Offset This field enables/disables the effects of the **RF In/Out**, **Aux RF Out**, and **Aux RF In** fields below it.

- When set to **On**, the RF Generator amplitude and RF Analyzer power measurement are offset by the values entered in these fields.
- When set to **Off**, the values in these fields are ignored.

See Also **Aux RF In Aux RF Out RF In/Out**

18. Screen Freeze This field enables/disables screen updating. The default setting is screen updating **OFF**. When enabled, all keys and control knob are still active.

The primary use of this field is for GPIB control. When this field is returned to **ON**, the screen returns to the state it was in when measurements were being made. Screen freezing is used to enhance speed improvements.

19. SERVICE This field in the To Screen list is only present on the Configure screen. It allows access to the Service screen.

20. Time This field sets the internal instrument clock.

CW Measurement

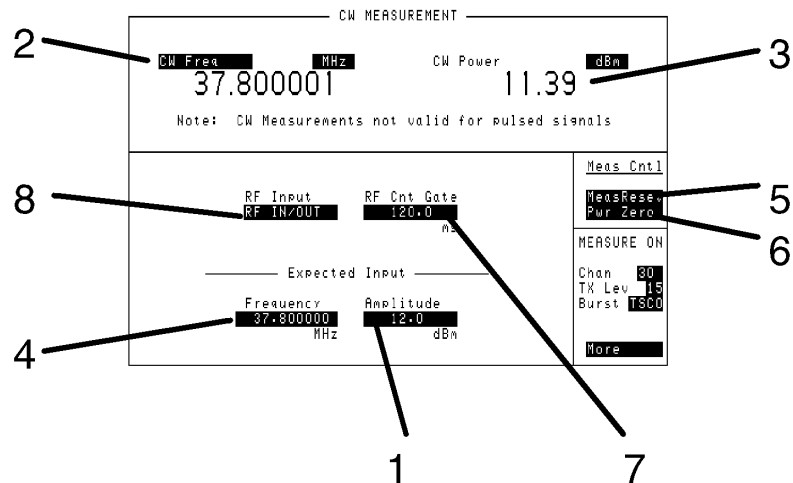

1. Amplitude (Expected Input)

This field is the input amplitude to be assumed at the selected RF analyzer input. The amplitude shown is for the port selected in the RF Input field.

Range RF IN/OUT: -27.9 to +41.0 dBm. AUX RF IN: -58.0 to +20.0 dBm.

See Also Screens: RF Analyzer/RF Generator (RF Generator). Chapter 3: Specifications

2. CW Freq, CWFreqErr

This field selects the type of measurement to be made on the signal at the RF input. This measurement is valid only for non-pulsed signals. The input frequency needs to be within ± 500 kHz of the value set as the Expected Input (4).

Choices **CW Freq** displays the measured frequency.
CWFreqErr displays the measured frequency error relative to the continuous wave frequency set in the RF Analyzer's Frequency field.

See Also Keys: ON/OFF, HI LIMIT, LO LIMIT, REF SET, AVG, METER, Units

- 3. CW Power** This field displays the measured CW power. This measurement is valid only for non-pulsed signals at the front-panel RF IN/OUT connector. This measurement is made at the frequency entered in the Frequency field.
- See Also** Keys: ON/OFF, HI LIMIT, LO LIMIT, REF SET, AVG, METER, Units
- 4. Frequency (Expected Input)** This field sets the frequency of the signal to be measured. It needs to be within ± 500 kHz to ensure the correct readings of amplitude (3) and frequency (2).
In the GSM band, the value that is entered should be set to the nearest 100 kHz.
- 5. Meas Reset (Meas Cntl)** Selecting Meas Reset will erase any accumulated measurements used for calculating a final result, and re-start the measurement process for the following functions:
- HI LIMIT
 - LO LIMIT
 - AVG
- This field resets the AF Analyzer measurements.
- See Also** Keys: HIGH LIMIT, LO LIMIT, AVG
- 6. Pwr Zero (Meas Cntl)** This field zeros the power meter. RF power must be disconnected from the RF IN/OUT port when executing this function.
- 7. RF Cnt Gate** This field sets the frequency counter's gate time.
- Range** 0.11 seconds to 1 second.
- 8. RF Input** This field selects the front-panel RF input for the RF analyzer.
- Choices** RF IN/OUT
AUX RF IN

Fast Bit Error

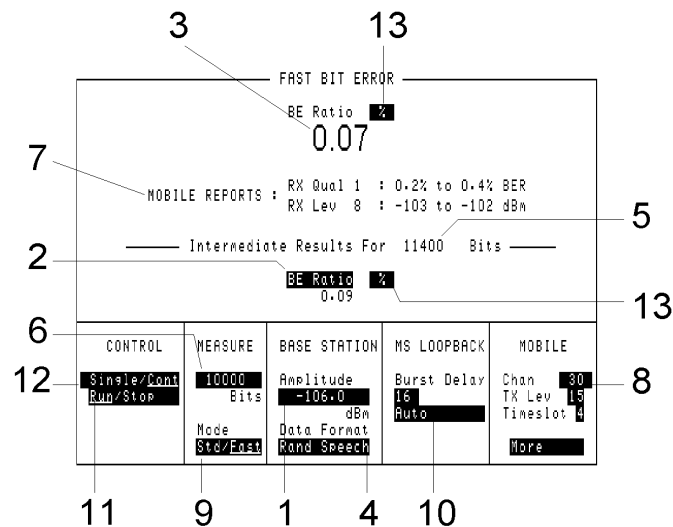

- 1. Amplitude (Base Station)** This field changes the RF generator amplitude. It is a duplicate of the RF generator's Amplitude field on the RF Generator/RF Analyzer screen.

See Also Screens: RF Generator/RF Analyzer (RF Generator).
- 2. BE Ratio** This field selects how bit errors will be displayed.

Choices **BE Count** displays the total number of bit errors.
BE Ratio calculates and displays the ratio of bit errors counted to the total number of bits measured (depends on measurement type).
- 3. BE Ratio/Count** This field displays the result of the bit error ratio after all the bits have been tested.
- 4. Data Format** This field allows the user to select the data format for the BER measurements.

Choices **RAND SPEECH** this uses random speech frames and enables the mobile to calculate Rx Quality correctly.
RAND BURSTS this generates random bursts, but the mobile is unable to calculate Rx Quality.

- 5. Intermediate Results** This field displays the number of bits that have been tested during a measurement that is currently running. This number includes only bits that are tested by the selected measurement type.
- 6. Measure Bit Type** Displays the fixed type of bit error test result.
- 7. Mobile Reports** The mobile reports reflect the status of the signal the mobile is receiving. These are:
- RX Qual
 - RX Lev
- 8. Mobile** When Compatibility Switch mode is being used (refer to Chapter 3, Using Compatibility Switch), **Chan**, **TX Lev** and **Timeslot** fields under **Mobile** are replaced with the To Screens List (see item Field Types, (5) at the start of this chapter).
- 9. Mode** This field sets which screen will be displayed once the Bit Error measurements has been selected from the Cell Control screen.
- Choices** **STD** means the screen will display the standard Bit Error Screen. **FAST** means the screen will display the Fast Bit Error Screen, as shown above.

Screens

Fast Bit Error

- 10. MS Loopback** This field is used to enter or display the Round Trip Delay (RTD) of the mobile (expressed in number of TDMA frames), before bits are compared. The correct number of TDMA frames can be determined automatically by making a Bit Error Test using Auto Mode when the bit error ratio is approximately <20%. Then, if faster measurements are desired or if the bit error ratio exceeds 20%, change the mode to manual.
- Choices** Burst Delay - range 0 through 26.
Manual
Auto
- When Compatibility Switch mode is used (refer to Chapter 3, Using Compatibility Switch), two additional fields appear under the new heading **Loopback**.
- Bit Error measurements are not automatic when in Compatibility Switch mode. The additional fields allow manual control of test loop commands to the mobile. When selecting **OFF**, an open test loop command is sent to the mobile and selecting **FAST** sends a close test loop command.
- See Also** Screens: Bit Error Test (Manual, Auto)
- 11. Run/Stop (Control)** Run starts a bit error test. Stop discontinues the bit error test in progress.
- 12. Single/Cont (Control)** Single allows one test to be performed. Cont allows testing to automatically repeat.
- 13. % BE Ratio** This field allows you to select between a display showing the percentage of errors (select **MHz**) and ppm (select **W**) which gives you the errors in parts-per-million.
- See Also** Keys: ON/OFF, LO LIMIT, HI LIMIT, REF SET, AVG, Units

I/O Configuration

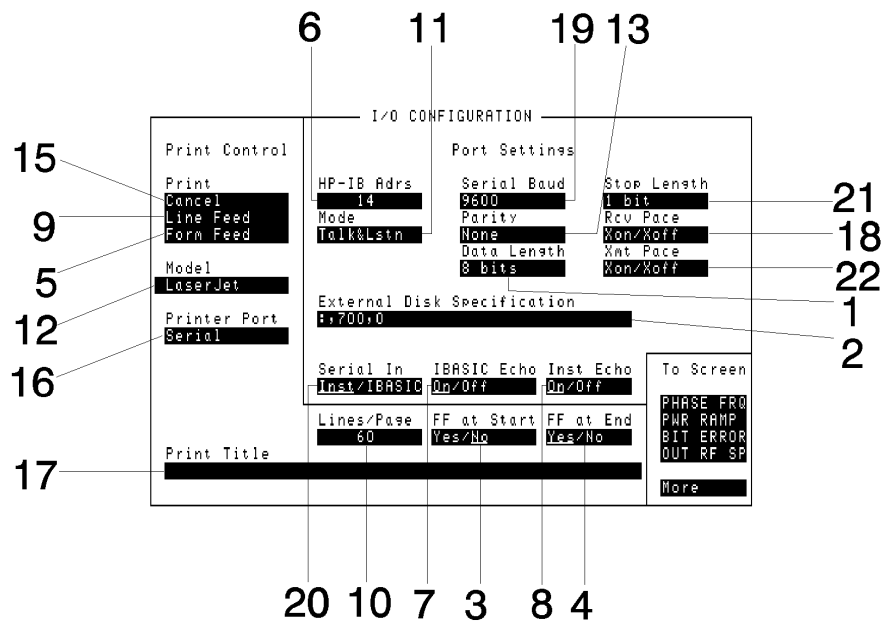

1. Data Length

This field sets the Serial Port word length.

Choices **7 bits**
 8 bits

2. External Disk Specification

This field sets the external disk address used by the Tests screen's Location field when it is set to Disk.

See Also **Keys: Tests**

3. FF at Start

This field allows you to select whether or not to have a form feed at the start of the printout. If Yes is selected the printout automatically starts at the beginning of a new page. The default setting is No.

4. FF at End

This field allows you to select whether or not to have a form feed at the end of the printout. The default setting is Yes.

Screens
I/O Configuration

- 5. Form Feed** This field allows you to select a form feed. This field is independent of FF at Start and FF at End.
- 6. HP-IB Adrs** This is the GPIB address entry field. It represents the address of the instrument.
Range 0 to 30.
- 7. IBASIC Echo** This field turns IBASIC echo on or off. When IBASIC Echo is on, non-graphic characters printed to the Agilent 8922M/S display during a "Print-to-Screen" operation, will also be printed to a PC terminal.
- 8. Inst Echo** This field turns instrument echo on or off. When Inst Echo is set to on, IBASIC commands entered into the Agilent 8922M/S through a computer or ASCII RS-232 terminal will appear on both the Agilent 8922M/S screen and the terminal.
- 9. Line Feed** This field allows you to select individual line feeds.
- 10. Lines/Page** This field allows you to select the number of lines to be printed on each page. The default setting is 60.
Range 20 through 120
- 11. Mode** This field selects the remote, GPIB operation mode.
Choices **Talk&Lstn** sets the instrument to normal GPIB operation.
Control turns the instrument into the GPIB controller.
- 12. Model** This field allows you to select which printer is connected. The default setting is the HP Thinkjet.
Choices
HP Printers Deskjet
Laserjet
Paintjet
Quietjet
Thinkjet
Epson Printers FX-80
LQ-850

- 13. Parity** This field selects parity for the rear panel serial port.
- Choices** **None**
 Odd
 Even
 Always 1
 Always 0
- 14. Print Adrs** This field sets the GPIB print address. This field only appears when the Printer Port is set to GPIB.
- Range** 0 through 30
- 15. Print Cancel** This field cancels printing.
- See Also** Keys: Print
- 16. Printer Port** This field allows you to select the printer port. The default setting is Serial.
- Choices** **Serial**
 HP-IB (Note that the GPIB address is also required with this selection.)
 Parallel
- 17. Print Title** This field is used to enter a title, up to 50 characters, to be printed at the top of all screen printouts.
- Choices** **Done** enters the data into the Agilent 8922M/S.
 Position moves the cursor to any position in the title block.
 Over/Ins When the cursor is blinking, you are in insert mode. when the cursor is not blinking, you are in typeover mode.
 Delete erases the character at the cursor.
 Del End erases all the characters from the cursor position to the end of the string (including the character at the cursor).
 Bk Space erases the characters in the space previous to the cursor.
 Upper and lower case letters: A through Z.
 Numerals: 0 through 9
 Special characters: space _ " # \$ % & ' () * + , - . / : ; < = > ? @ [\] ^ ` { | } ~

- 18. Rcv Pace** This field is used to select if data will be paced through the serial port.
- Choices** **None** disables the Xon/Xoff function
 Xon/Xoff sets ASCII control codes Xon and Xoff to either start or stop data transmission from the computer to the instrument.
- 19. Serial Baud** This field sets the baud rate for serial port.
- Choices** **300**
 600
 1200
 2400
 4800
 9600
 19200
- 20. Serial In** This field configures the serial port (Inst) communication to the serial input port or IBASIC control of the serial input port.
- **Inst** configures the serial port to connect to an external ASCII RS-232 terminal or computer.
 - **IBASIC** allows the IBASIC controller to read the serial port.
- 21. Stop Length** This field sets the number of stop bits used for serial communication.
- Choices** **1 bits**
 1.5 bits
 2 bits
- 22. Xmt Pace** This field is used to select if data will be paced through the serial port.
- Choices** **None** disables the Xon/Xoff function.
 Xon/Xoff sets ASCII control codes Xon and Xoff to either start or stop the instrument from transmitting to the computer.

Logging



IMPORTANT

Option 003 must be installed and an external Protocol Logger must be connected for Logging functions to work.

For full details on this option and this screen, refer to Appendix A, Protocol Logging.

Measurement Sync

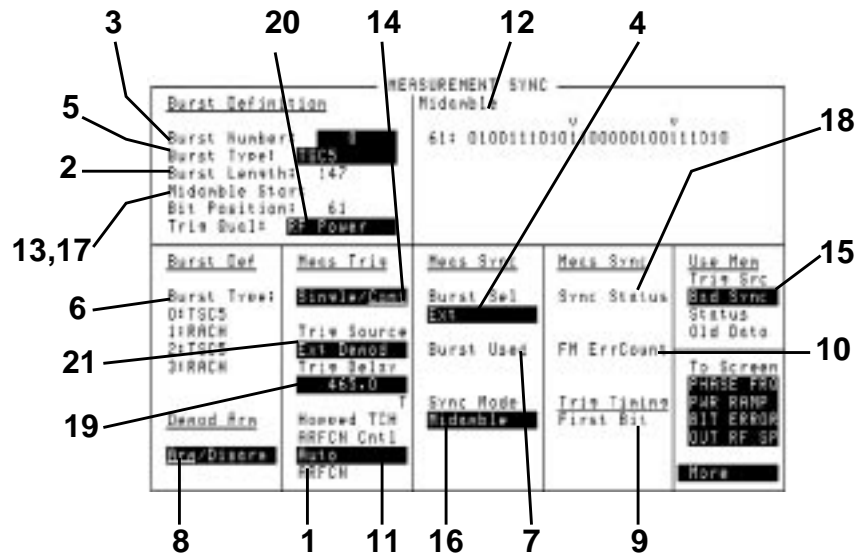

This screen defines settings that determine how synchronization will occur for any of the following measurements:

- Pwr Ramp and Pulse
- Output RF Spectrum
- Pulse On/Off Ratio

1. ARFCN

If Auto is chosen in the Hopped TCH ARFCN Cntl field, the measured ARFCN will be displayed, as soon as a measurement is completed on a Hopped TCH. This will be the lowest frequency ARFCN in the hop sequence.

If Specific is chosen from the Hopped TCH ARFCN Cntl field, enter a specific ARFCN from the hop sequence. After Meas Arm is selected, the Agilent 8922M/S will make a measurement when the mobile is transmitting on the selected frequency.

2. Burst Length

This field displays the burst length of the Burst Type selected. If Burst Type is set to User Defined, the Burst Length will be 87 or 147.

3. Burst Number

This field selects which burst definition is being displayed.

Range 0 to 3.

- 4. Burst Sel** This field selects the burst that the measurement will synchronize to.
- Choices** **0**
 1
 2
 3
Ext is used for selecting burst number 0, 1, 2, or 3 in real-time using the SYSTEM BUS (rear-panel connector) or using internal signals while Activated.
- 5. Burst Type** This field defines the burst type. Choose from eleven burst types, or User Def for specifying a user defined burst type.
- Choices** **TSC0 through TSC7** (Training Sequence Codes) are used for normal bursts.
RACH (Random Access Channel) is used for access bursts.
SCH (Synchronization Channel) is used for synchronization bursts.
FCH (Frequency Channel) is used for frequency correction bursts.
User Def (User Defined) is used when your burst does not conform to any of the burst types listed (such as PRBS), or when measuring noisy signals.
- User defined burst lengths must be 87 or 147 (plus 4 guard bits), and the User Defined Sync Pattern can comprise part of or all of the bits in the burst.
- To measure a noisy signal (approx 10 deg rms), enter the entire burst in User Defined Sync Pattern, and use Midamble Expected (see Screens: DSP Analyzer: Data Bits or Phase Err). The ideal phase trajectory will be calculated from the User Defined Sync Pattern, eliminating the problem of extremely high peak phase error due to bit errors.
- User Def is not allowed for Digital Demod.
- 6. Burst Type** This field displays a summary of the Burst Type definitions for the four definable bursts.
- 7. Burst Used** This field displays which one of four possible burst types was used for synchronization or alignment during a measurement. Refer to the Burst Definition or Burst Def fields.

8. Demod Arm This field arms or disarms triggering for digital demodulation. It is identical to the Demod Arm State field on the Digital Demod screen.

IMPORTANT

This field is set to Disarm whenever a measurement screen (Output RF Spectrum, Phase/Frequency or Pulse) is accessed. When Demod Arm is disarmed, the Agilent 8922M/S cannot display information about the uplink. When Demod Arm is re-armed, the Cell Control fields that display information about the uplink will resume normal operation.

When Demod Arm is re-armed, measurement results (DSP Analyzer, Output RF Spectrum, Pulse) are lost.

9. First Bit This field displays the position in time of the of the burst's first useful bit relative to the delayed measurement trigger.

See Also Keys: ON/OFF, HI LIMIT, LO LIMIT, REF SET, AVG, Units

10. FM ErrCount This field displays the number of bit differences detected when comparing the demodulated data bits to the selected synchronization pattern when Sync Mode is set to Midamble. This field will display 0 if Sync Mode is set to Amplitude.

See Also Screens: MEAS SYNC

11. Hopped TCH ARFCN Cntl This field is used to determine the Agilent 8922M/S's method for selecting which ARFCN to measure during a hopping TCH.

The frequency of the ARFCN selected in this field is displayed in the HopMeasFreq field on the RF Generator/RF Analyzer screen.

Choices **Auto** causes the Agilent 8922M/S to make a measurement on the lowest ARFCN in the hop sequence and display it in the ARFCN field.

Specific requires that you enter an ARFCN in the field that appears when Specific is chosen. Make sure this ARFCN is in an MA table and the CA table (see Screens: Cell Configuration). If the specified ARFCN is not in the MA table, no measurement triggers will be generated and the Agilent 8922M/S will wait until the measurement is disarmed.

12. Midamble This field displays the midamble bit pattern of the Burst Type selected for bursts other than user defined bursts.

13. Midamble Start Bit Position/Sync Pattern Start Position If Midamble Start Bit Position is displayed, the number displayed represents the expected position (within the Burst Type you have selected) of the first bit of the burst's midamble. Example: If you have selected Burst Type TSC0, the Midamble Start Bit Position will be 61, and you will see this number displayed in this field and in the Midamble field to the right.

If Sync Pattern Start Position is displayed, the number displayed represents the expected position (within a User Defined burst) of the first bit in a user defined pattern that the DSP Analyzer will try to synchronize to. The field labeled Burst Type must be set to User Def for Sync Pattern Start Position to be displayed.

14. Single/Cont (Meas Trig) Single performs one GSM measurement (DSP Analyzer, Pulse On/Off, and Output RF Spectrum) after Meas Arm is selected and a valid trigger event occurs.
Cont performs GSM measurements continuously. Each time a GSM measurement is performed, the measurement screen will be updated with new information.

NOTE Screens that display traces update more slowly than screens that display numbers.

NOTE If no measurements are being made while in continuous (Cont), check Trig Qual (see Screens:RF Generator/RF Analyzer). If it is set to RF Power, change it to Normal.

15. Status (Use Mem) This field will indicate whether any data is available for a Use Mem measurement, and whether current data has had a measurement performed on it. (The Use Mem function allows DSP measurements over one archived GSM burst.)

- **No Data:** No data has been stored.
- **Old Data:** Data is available for a measurement, but Digital Demod has been disarmed and then armed again since the data was stored. This indicates that a measurement was made on the data.
- **New Data:** Data is available for a measurement and Digital Demod has not been disarmed and then armed again since the data was stored.

See Also Keys: Use Mem Screens: Measurement Sync (**Status (Use Mem)**) Screens: Digital Demod (**Trig Source (Use Mem)**)

16. Sync Mode This field selects how the location of the demodulated data bits are determined within the measured burst.

Choices **Midamble** attempts to bit pattern match the demodulated data bits to the selected Midamble or User Defined Sync Pattern.
Amplitude centers the demodulated data within the detected amplitude envelope.

Screens

Measurement Sync

17. Sync Pattern Start Position This field is only displayed when Burst Type is set to User Def. It selects the starting bit position of a user defined synchronization pattern.

Range 0 to 147.

18. Sync Status This field displays problems that were detected during digital demodulation or DSP analyzer measurements.

See Also Making Measurements: Solving Problems Messages

19. Trig Delay This field sets the time delay between a valid trigger event and the beginning of a measurement.

Range 0 to 5000.00 μ s.

20. Trig Qual This field selects whether a trigger qualifier will be used.

Choices **Normal**, no trigger qualifier is used.
RF Power, trigger events will only be valid when RF power is detected at the selected input. If no RF Power is present at the time of the trigger, the measurement will re-arm after seven timeslots.

NOTE If no measurements are being made while in continuous (Cont), check Trig Qual (see Screens:RF Generator/RF Analyzer). If it is set to RF Power, change it to Normal.

21. Trig Source This field selects the source of the trigger. When Activated (see Screens: Cell Configuration), triggers for digital demodulation are generated internally.

Choices **Ext Demod** selects triggering through RP_DMOD_TRIG on the rear-panel SYSTEM BUS CONNECTOR.
RF Rise selects triggering when the rising edge of an RF signal is detected. RF Rise is used with pulsed RF input signals.
Ext Meas selects triggering through the MEASURE TRIGGER IN front panel connector.

Message

```
MESSAGE
Press PREV to return to the previous screen.

Please wait for Base Station configuration to complete.
time 12:44:19 on
Please wait for configuration to new Radio Tree.
time 12:50:08 on
Please wait for Base Station configuration to complete.
time 12:50:10 on
Passing mobile on INSI '001012345678901'
time 12:50:16 on
Please wait for Base Station configuration to complete.
time 1:12:34 on
Passing mobile on INSI '001012345678901'
time 9:44:22 on
Please wait for Base Station configuration to complete.
time 10:02:53 on
Passing mobile on INSI '001012345678901'
time 10:03:15 on
Output RF Spectrum reference measurement completed.
time 10:15:57 on to 10:16:17 on: 30 times
Cannot change settings while Armed for Digital Dead-
time 10:16:41 on
```

This screen makes a record of any messages. Up to 10 messages can be displayed. If the 10-message limit is exceeded, the latest message is added to the bottom of the screen, and the top message is removed from the screen.

If the same operation error occurs multiple times, you will see the number of occurrences at the end of the message.

MS Information / Signaling

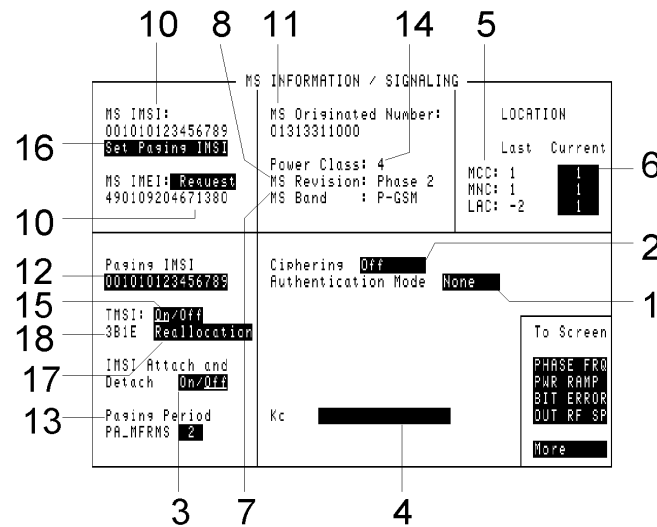

1. Authentication Mode

Choices

None results in no authentication being performed. (This field only applies if Special Option H05 is fitted.)

Full-64 Authentication Mode requires that you use a test SIM that implements the authentication algorithm specified in Rec. 11.10, sec. III.1.6.3

- You must enter an Authentication Key (Ki). If no Ki is entered, a default value of 0 is used.
- When an authentication request occurs, the BS SRES generated by the Agilent 8922M/S should match the MS SRES received from the mobile station.

Full-54 Authentication Mode requires that you use a test SIM that implements the authentication algorithm specified in Rec. 11.10, sec. III.1.6.3

- The Agilent 8922M/S generates 0's for the 10 least significant bits of the 64 bit Cipher Key (Kc).

- You must enter an Authentication Key (Ki). If no Ki is entered, a default value of 0 is used.
- When an authentication request occurs, the BS SRES generated by the Agilent 8922M/S should match the MS SRES received from the mobile station.

Partial Authentication Mode requires that you enter a RANDOM number and the associated Kc for a particular SIM. The MS SRES from the mobile station will be displayed, but no BS SRES will be generated by the Agilent 8922M/S.

2. Ciphering

This field selects the ciphering mode of the mobile station and the Agilent 8922M/S during the next call made.

Choices

Off results in no ciphering signal.

Enabled (Special Option H05 only) sends a ciphering mode message and enables ciphering. (If the Authentication Mode is Full-64 or Full-54, MSRES and BSRES must match for the call to proceed and enable ciphering).

Disabled sends a ciphering mode message, and disables ciphering.

3. IMSI Attach/Detach

This field allows you to select whether or not the mobile automatically performs a location update after synchronizing to the BCH, regardless of whether the cell attributes are the same as those stored by the mobile. This allows the mobile phone to report its IMSI as part of the camping operation.

4. Kc

This field is only used if Special Option H05 is fitted. It displays the Ciphering Key (Kc) generated by the Agilent 8922M/S when the Authentication Mode is Full.

If the Authentication Mode is Partial or None, you must enter Kc into this field.

The Agilent 8922M/S will use all 64 bits from this field. Entries into the Kc field must account for any truncation of bits that may be done by the mobile station.

Example: If the mobile station truncates 10 bits, resulting in a 54-bit Kc, enter a hexadecimal number in the Agilent 8922M/S Kc field that correctly positions the 54 bits that will be used, inserting 0's where necessary.

5. Last LAI

These fields display the mobile station's LAI (Local Area Identification) after the last location update.

6. Location

This area allows you to adjust the serving cell location information.

- 7. MS Band Capability** This field displays the value encoded in the Frequency Capability bits of the mobile station classmark 2 as defined in ETSI-GSM 04.08.10.5.1.6.
- 8. MS Revision** This field displays the value encoded in the Revision Level bits of the mobile station classmark 1 and 2 as defined in the ETSI-GSM 04.08.10.5.1.5 and 10.5.1.6 respectively. The field displays a value of Phase 1 or Phase 2.
- 9. MS IMEI:Request** When this field is selected during a call, the Agilent 8922M/S will attempt to obtain the IMEI (International Mobile Equipment Identity) number of the mobile station. If a correct IMEI number is obtained, it will be displayed directly below MS IMEI:Request.
- 10. MS IMSI** This field displays the mobile station's IMSI (International Mobile Subscriber Identity) number, obtained from the mobile station during call setup or a location update.
- 11. MS Originated Number** This field displays the called party BCD number the mobile station sent during the last MS originated call.
- This field is updated each time an MS initiated call is accepted.
- This field is blank if no called party BCD number was included in the message from the mobile station.
- If an emergency call is made, 112_EMERGENCY_CALL is displayed.
- 12. Paging IMSI** This is the IMSI number the Agilent 8922M/S will use when paging the mobile station. If you would like to automatically enter an MS (mobile station) obtained IMSI into this field, make a MS originated call, then select Set Paging IMSI. Alternatively, set IMSI Attach/Detach to On before the mobile phone camps to the Agilent 8922M/S.
- You can also enter the IMSI number manually.
- 13. Paging Period** This field allows the user to modify the BS-PA-MFRMS field in the Control Channel Information Element of the System Information Type 3 message. The purpose of this field is to specify the multiframe period for transmission of Paging Request Messages.
- Range** 2 to 9.

- 14. Power Class** This field displays the power class of the mobile station, as sent by the mobile station during a call. This number will correspond with a maximum power level the mobile station is allowed to transmit.
- 15. TMSI On/Off** When On is selected, the Agilent 8922M/S will attempt to identify the mobile station by its TMSI (Temporary Mobile Subscriber Identity) number. A random TMSI number is generated for reallocation to a mobile station. The random TMSI number is displayed in the TMSI Number field.
- The TMSI is checked as part of the call setup process. During an initial call setup with a mobile station, the TMSI will have to be assigned to the mobile station by the Agilent 8922M/S. This assigned TMSI is then expected by the Agilent 8922M/S during subsequent call setups, as long as a TMSI is used and the IMSI remains the same.
- If a TMSI received from the mobile station is not valid, the Agilent 8922M/S will calculate a new TMSI and reallocate it to the mobile station as part of the call setup. The following situations can cause a TMSI to not be valid; when the mobile station identifies itself with an IMEI number (emergency call), or when a new IMSI is used.
- When Off is selected, the mobile station will continue to use the old TMSI until the next location update occurs. When the next location update occurs, the mobile station will be instructed to delete its last TMSI, and the Agilent 8922M/S will perform the identification procedure to determine the IMSI.
- 16. Set Paging IMSI** When this field is selected, the MS IMSI number reported by the mobile station is copied to the Paging IMSI field, to be used for Agilent 8922M/S BS (base station) originated calls (Mobile Terminated Calls).
- 17. Reallocation** When this field is selected a random TMSI number is generated for allocation to a mobile station. The random TMSI number is displayed in the TMSI Number field.
- 18. TMSI Number** This field displays the current Temporary Mobile Subscriber Identity (TMSI) number assigned to the mobile station.
- If a TMSI received from the mobile station is not valid, the Agilent 8922M/S will calculate a new TMSI and automatically reallocate it to the mobile station. Any time a signaling link is established, TMSI reallocation can be performed manually. See Reallocation.
- Ki** This field is used to enter the mobile station's Authentication Key (Ki). When the Authentication Mode is Partial or None, this field is not displayed.

Screens

MS Information / Signaling

- RAND** This field displays the RAND number when the Authentication Mode is Full. You must enter the RAND number (and Kc) when the Authentication Mode is Partial. This field is not displayed when Authentication Mode is None.
- MS SRES** This field is the Mobile Stations Signed RESponse to an authentication request. When the Authentication Mode field is None, this field will be blanked. When the Authentication Mode is Full, BSRES and MSRES should match. If BSRES and MSRES don't match, the call will be cleared.
- BS SRES** This field is the Base Stations Signed RESponse, and is only displayed when Authentication Mode is Full.
- BSRES is calculated by the Agilent 8922M/S, then used to validate MSRES by checking for a match between BSRES and MSRES.
- When the Authentication Mode field is Partial or None, this field will be blanked.

Oscilloscope, Main Controls

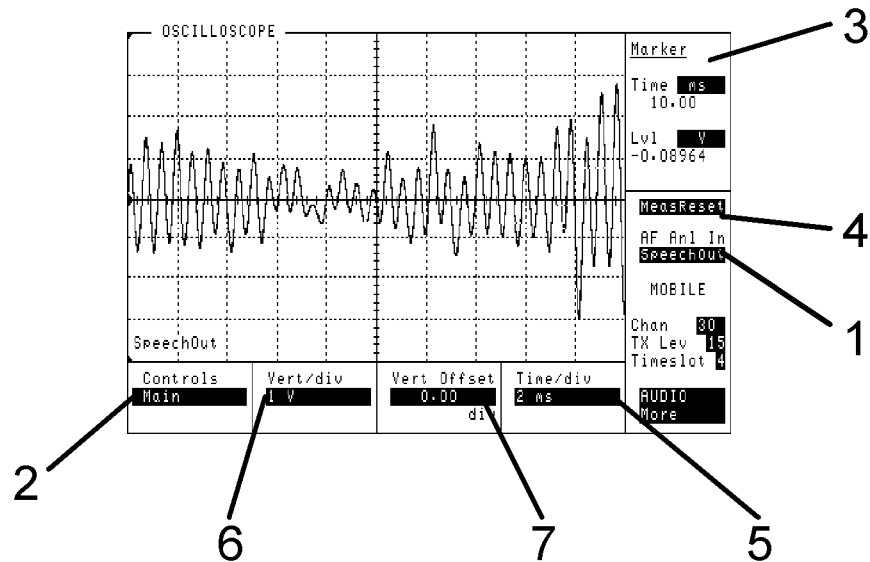

1. AF Anl In

This field selects the AF analyzer input.

Choices

Scope In selects the SCOPE IN (MEASURE) front-panel connector.

Speech Out selects the signal going to the MON/SPEECH (DEMODULATION OUT) front-panel connector.

AM Mod In selects the IN AM/SPEECH (MODULATION) front-panel connector.

Speech In selects the IN AM/SPEECH (MODULATION) front-panel connector.

FM Demod selects the FM demodulation discriminator.

Pls Demod selects the pulse demodulation detector.

Audio In selects the IN (AUDIO) front-panel connector.

Audio Out selects the signal going to the AUDIO OUT front-panel connector.

NOTE

Scope In, **AM Mod In**, and **Speech In** are not featured in the Agilent 8922S.

Screens

Oscilloscope, Main Controls

- 2. Controls** This field selects the set of oscilloscope controls.
- Choices** Main
Trigger
Marker
- 3. Marker** This field displays the signal level at the current marker position. The units-of-measure for this field are determined by the AF An1 In selection.
- See Also** Keys: ON/OFF, HI LIMIT, LO LIMIT, REF SET, AVG, Units
- 4. Meas Reset** Selecting Meas Reset will erase any accumulated measurements used for calculating a final result, and re-start the measurement process for the following functions:
- HI LIMIT
 - LO LIMIT
 - AVG
- See Also** Keys: HI LIMIT, LO LIMIT, AVG
- 5. Time/div** This field selects the horizontal sweep time per division.
- Choices** 200, 100, 50, 20, 10, 5, 2, or 1 ms
500, 200, 100, 50, 20, 10, 5, 2, or 1 μ s
- 6. Vert/div** This field, vertical sensitivity, sets the vertical amplitude per division. The units-of-measure for this field are determined by the AF An1 In selection. When selecting upper or lower limits of vertical sensitivity, an **UNCAL** message appears on the display. This message indicates that the scope is operating out with calibrated ranges.
- See Also** Screens: Audio, (**AF An1 In**)
- 7. Vert Offset** This field moves the displayed signal trace above or below the oscilloscope's fixed centerline.

Oscilloscope, Trigger Controls

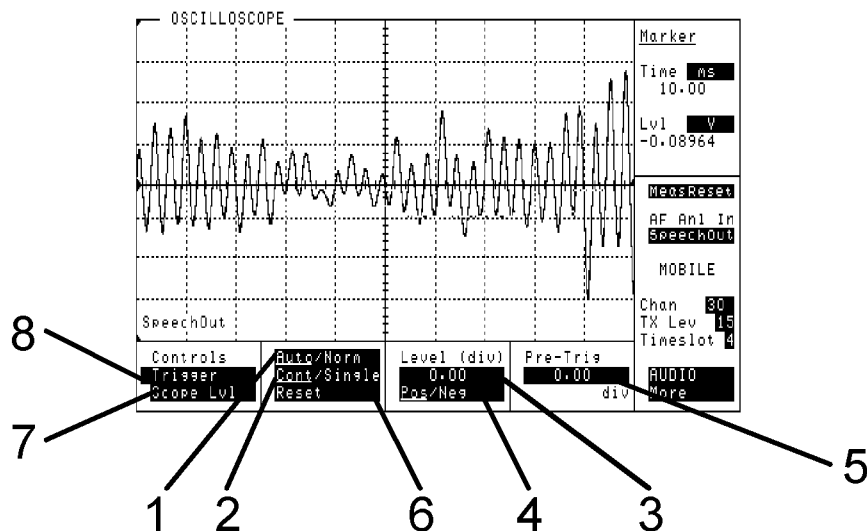

1. AF Anl In

This field selects the AF analyzer input.

Choices

- Scope In** selects the SCOPE IN (MEASURE) front-panel connector.
- Speech Out** selects the signal going to the MON/SPEECH (DEMODULATION OUT) front-panel connector.
- AM Mod In** selects the IN AM/SPEECH (MODULATION) front-panel connector.
- Speech In** selects the IN AM/SPEECH (MODULATION) front-panel connector.
- FM Demod** selects the FM demodulation discriminator.
- Pls Demod** selects the pulse demodulation detector.
- Audio In** selects the IN (AUDIO) front-panel connector.
- Audio Out** selects the signal going to the AUDIO OUT front-panel connector.

NOTE

Scope In, **AM Mod In**, and **Speech In** are not featured in the Agilent 8922S.

Screens

Oscilloscope, Trigger Controls

- 2. Auto/Norm** Auto automatically triggers a sweep if a triggering signal is not detected within ~50 ms of the end of the previous sweep in Cont triggering mode.
Norm requires a specific triggering signal before triggering can occur.
- 3. Controls** This field selects the set of oscilloscope controls.
Choices Main
Trigger
Marker
- 4. Cont/Single** This field specifies how measurements are armed to accept a trigger.
If Cont is selected, the oscilloscope is continuously armed to accept a sweep trigger.
If Single is selected, the oscilloscope is armed each time Reset is selected.
- 5. Level (div)** This field sets the trigger level when the **Scope Lv1** is the trigger source. The trigger level is indicated by small pointers that appear on each side of the graticule. The units are vertical divisions.
- 6. Marker** This field displays the signal level at the current marker position. The units-of-measure for this field are determined by the AF Anl In selection.
See Also Keys: ON/OFF, HI LIMIT, LO LIMIT, REF SET, AVG, Units
- 7. Meas Reset** Selecting Meas Reset will erase any accumulated measurements used for calculating a final result, and re-start the measurement process for the following functions:
- HI LIMIT
 - LO LIMIT
 - AVG
- See Also** Keys: HI LIMIT, LO LIMIT, AVG
- 8. Pre-Trig** This field specifies the number of horizontal divisions to be displayed previous to the trigger point. The trigger point is indicated by small pointers that appear at the top and bottom of the graticule.
- 9. Pos/Neg** This field specifies whether triggering occurs on the trigger signal's positive-going (Pos), or negative-going (Neg) slope.

10. Reset This field is used to arm a sweep trigger when Single is selected.

11. Scope Lvl This field selects the trigger source.

Choices **Scope Lvl** uses the input signal level for triggering.
External uses the front-panel MEASURE TRIGGER IN signal for triggering.

Oscilloscope, Marker Controls

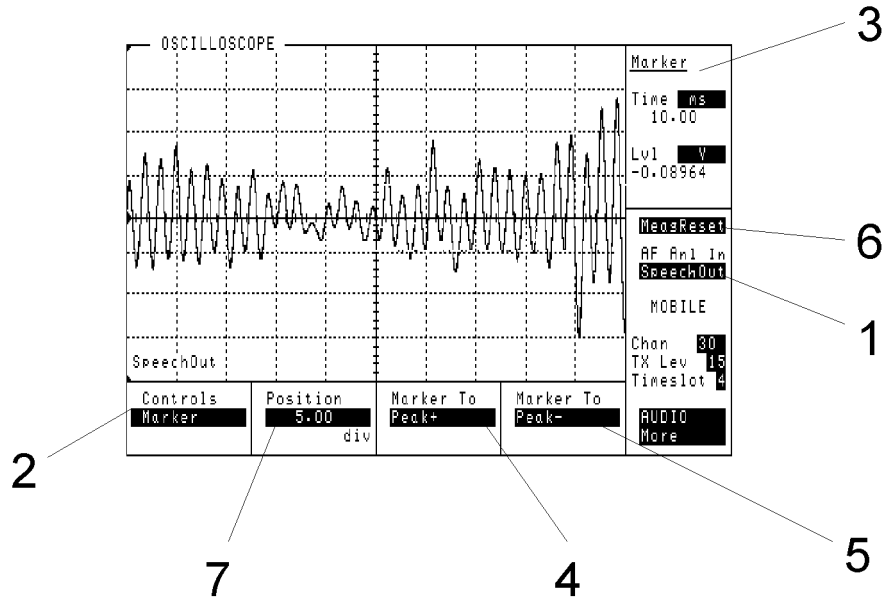

1. AF Anl In

This field selects the AF analyzer input.

Choices

Scope In selects the SCOPE IN (MEASURE) front-panel connector.

Speech Out selects the signal going to the MON/SPEECH (DEMODULATION OUT) front-panel connector.

AM Mod In selects the IN AM/SPEECH (MODULATION) front-panel connector.

Speech In selects the IN AM/SPEECH (MODULATION) front-panel connector.

FM Demod selects the FM demodulation discriminator.

Pls Demod selects the pulse demodulation detector.

Audio In selects the IN (AUDIO) front-panel connector.

Audio Out selects the signal going to the AUDIO OUT front-panel connector.

NOTE

Scope In, **AM Mod In**, and **Speech In** are not featured in the Agilent 8922S.

- 2. Controls** This field selects the set of oscilloscope controls.
- Choices** Main
Trigger
Marker
- 3. Marker** This field displays the signal level at the current marker position. The units-of-measure for this field are determined by the AF An1 In selection.
- See Also** Screens: Audio, (AF Analyzer **AF An1 In**) Keys: ON/OFF, HI LIMIT, LO LIMIT, REF SET, AVG, Units
- 4. Marker To (Peak+)** This field causes the marker to move to the highest positive peak displayed.
- 5. Marker To (Peak-)** This field causes the marker to move to the lowest negative peak displayed.
- 6. Meas Reset** Selecting Meas Reset will erase any accumulated measurements used for calculating a final result, and re-start the measurement process for the following functions:
- HI LIMIT
 - LO LIMIT
 - AVG
- See Also** Keys
- 7. Position** This field controls the position of the marker.

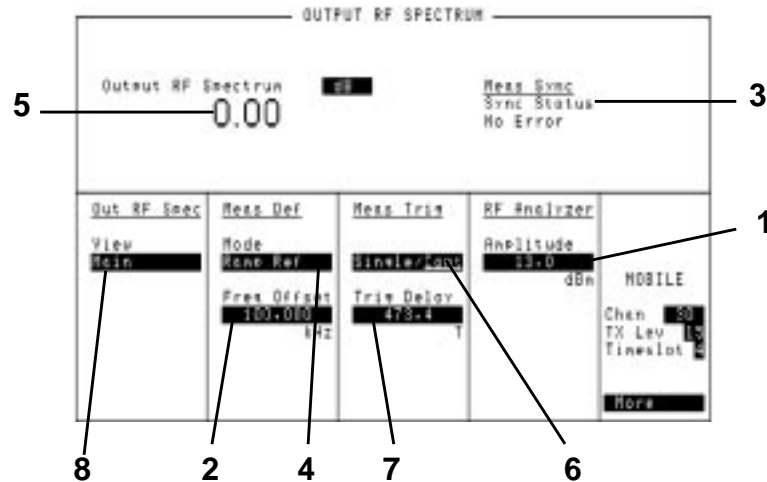
Output RF Spectrum, Main View (Option 006 Only)

The Agilent 8922M/S uses a 3-pole synchronously tuned filter to make Output RF Spectrum measurements rather than a 5-pole filter as specified in the GSM recommendations. Refer to Section titled “Output RF Spectrum Measurements Using a 3-Pole Synchronously Tuned Measurement Filter” in Chapter 2.

1. Amplitude

This is a copy of the RF Analyzer Amplitude field. This is the amplitude to be assumed at the selected input port, see RF Analyzer Functions).

Range RF IN/OUT: -27.9 to $+41.0$ dBm. AUX RF IN: -58.0 to $+20.0$ dBm.

See Also Screens: RF Generator/RF Analyzer, (RF Analyzer)

2. Freq Offset

This sets the frequency offset for the Output RF Spectrum measurement. This field is used when not making reference measurements. The offset used is 0.0 kHz when Mode is set to Ramp Ref or Mod Ref.

Range -2.0 MHz to $+2.0$ MHz.

3. Sync Status

This field displays any errors that occurred while trying to synchronize to the demodulated data.

See Also Making Measurements: Solving Problems Messages

- 4. Mode** This field selects the Output RF Spectrum measurement Mode.
- Choices** **Ramping** measures the Output RF Spectrum power due to ramping. (The peak value is returned within the time interval 28 μ s before bit 0 to 28 μ s after bit 147 or bit 87, depending on the burst type.)
Ramp Ref makes a reference measurement needed for the Output RF Spectrum measurement when making ramping measurements.
Modulatn (modulation) measures the Output RF Spectrum power due to modulation.
Mod Ref makes a reference measurement needed for the Output RF Spectrum measurement when making modulation measurements.
- 5. Output RF Spectrum** This field displays the measured Output RF Spectrum power at the specified Freq Offset setting.
- See Also** Keys: ON/OFF, HI LIMIT, LO LIMIT, REF SET, AVG, Units
- 6. Single/Cont** Single allows one test to be performed. Cont allows testing to automatically repeat.
- 7. Trig Delay** This field sets the time delay between a valid trigger event and the beginning of a measurement.
- Range** 0 to 5000.00 μ s
- 8. View** This field selects the alternate views of the Output RF Spectrum measurement.
- Choices** **Main** displays the Output RF spectrum display as a text screen.
Trace displays Output RF Spectrum power spectral density (at the Freq Offset setting) versus time.

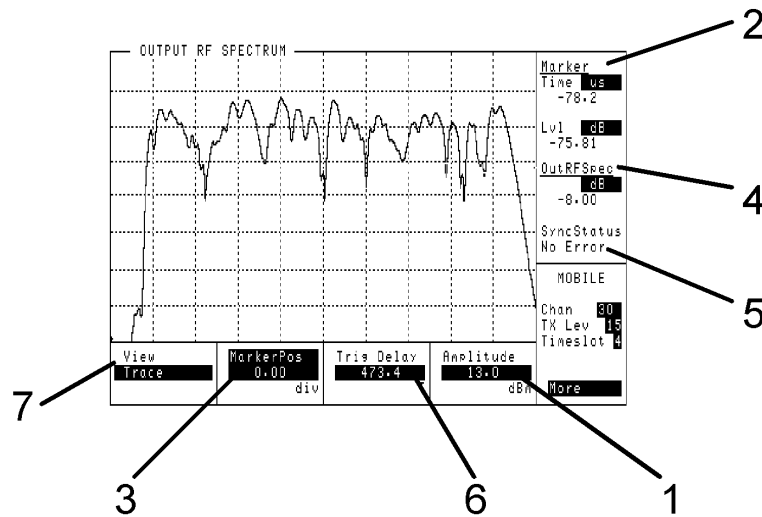
Output RF Spectrum, Trace View (Option 006 Only)

This view displays output RF spectrum power spectral density (at the Freq Offset setting) versus time.

The Agilent 8922M/S uses a 3-pole synchronously tuned filter to make Output RF Spectrum measurements rather than a 5-pole filter as specified in the GSM recommendations. Refer to Section titled “Output RF Spectrum Measurements Using a 3-Pole Synchronously Tuned Measurement Filter” in Chapter 2.

1. Amplitude

This is a copy of the RF Analyzer Amplitude field. This is the amplitude to be assumed at the selected input port.

Range RF IN/OUT: -27.9 to +41.0 dBm. AUX RF IN: -58.0 to +20.0 dBm.

See Also Screens: RF Generator/RF Analyzer (RF Analyzer)

2. Marker

This field displays the level at the current marker position.

See Also Keys: ON/OFF, HI LIMIT, LO LIMIT, REF, AVG, Units

- 3. MarkerPos** This field controls the marker position.
- Choices** **MarkerPos** selects the position of the marker on the screen.
 Freq Offs selects the frequency offset for the trace.
 Meas Mode selects the output RF spectrum measurement mode.
- 4. OutRFSpec** This field displays the measured Output RF Spectrum power at the specified Freq Offset setting.
- See Also** Keys: ON/OFF, HI LIMIT, LO LIMIT, REF, AVG, Units
- 5. SyncStatus** This field displays any errors that occurred while trying to synchronize to the demodulated data.
- See Also** Making Measurements: Solving Problems Messages
- 6. Trig Delay** This field sets the time delay between a valid trigger event and the beginning of a measurement.
- Range** 0 to 5000.00 μ s
- 7. View** This field selects the alternate views of the Output RF Spectrum measurement.
- Choices** **Main** displays the Output RF spectrum display as a text screen.
 Trace displays Output RF Spectrum power spectral density (at the Freq Offset setting) versus time.

Phase and Frequency Error - Multiburst OFF

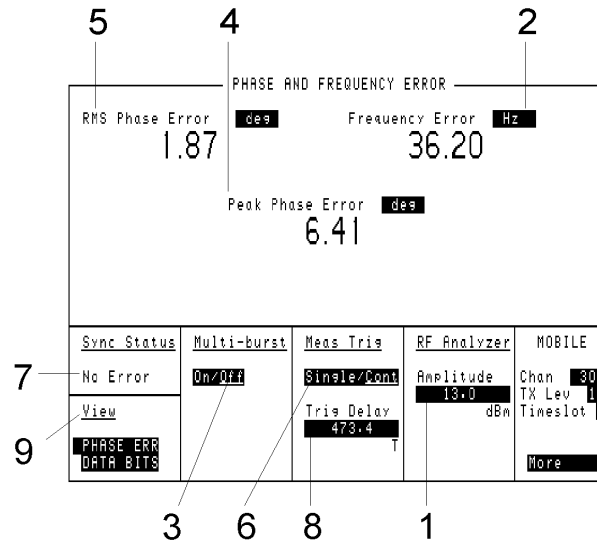
**1. Amplitude**

This is a copy of the RF Analyzer Amplitude field. This is the amplitude to be assumed at the selected input port.

Range RF IN/OUT: -27.9 to +41.0 dBm. AUX RF IN: -58.0 to +20.0 dBm.

See Also Screens: RF Generator/RF Analyzer, (RF Analyzer)

2. Frequency Error

This field displays the derived Frequency Error over the useful bits in the measured burst.

See Also Keys: ON/OFF, HI LIMIT, LO LIMIT, REF SET, AVG, METER, Units

- 3. ON/OFF** This field enables or disables multi-burst measurement. The default for this field is **OFF**.
- Choices** **ON** enables multi-burst measurement. The display changes to show Bursts measured fields; **Wanted**, **Done**, and **Errors**. **OFF** disables multi-burst measurement.
- See Also** Screens: Phase and Frequency Error - Multi-burst ON
- 4. Peak Phase Error** This field displays the measured Peak Phase Error over the useful bits in the measured burst.
- See Also** Keys: ON/OFF, HI LIMIT, LO LIMIT, REF SET, AVG, METER, Units
- 5. RMS Phase Error** This field displays the measured RMS Phase Error over the useful bits in the measured burst.
- See Also** Keys: ON/OFF, HI LIMIT, LO LIMIT, REF SET, AVG, METER
- 6. Single/Cont** Single allows one test to be performed. Cont allows testing to automatically repeat.
- 7. Sync Status** This field displays any errors that occurred while trying to synchronize to the demodulated data.
- See Also** Making Measurements: Solving Problems Messages
- 8. Trig Delay** This field sets the time delay between a valid trigger event and the beginning of a measurement.
- Range** 0 to 5000.00 μ s.
- 9. View** This field selects alternate views of the measurement.
- Choices** Phase Err
Data Bits

Phase and Frequency Error - Multi-burst ON

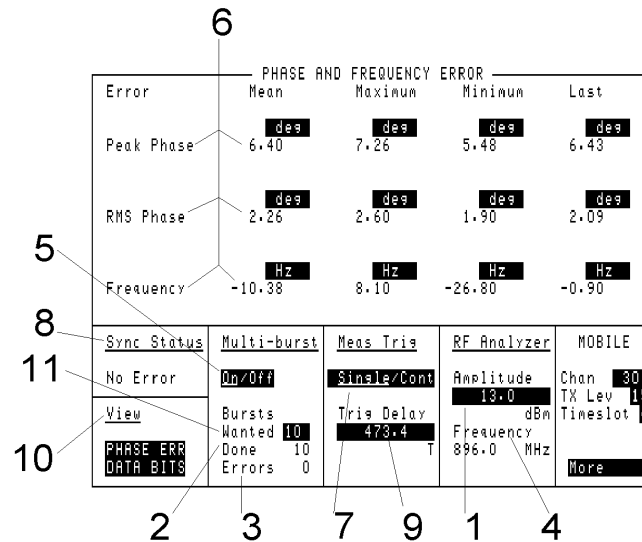

NOTE

When multiburst is turned on, display update rate for power versus time and phase traces will be slowed down while multiple bursts are collected.

1. Amplitude

This is a copy of the RF Analyzer Amplitude field. This is the amplitude to be assumed at the selected input port.

Range RF IN/OUT: -27.9 to +41.0 dBm. AUX RF IN: -58.0 to +20.0 dBm.

See Also Screens: RF Generator/RF Analyzer, (RF Analyzer)

2. Done

This field displays the number of bursts that have been carried out during a measurement cycle. It is updated every three bursts. When the measurement cycle is complete, this field will display the same number of bursts originally selected for the measurement cycle. This field includes bursts which are counted as errors.

See Also Screens: Phase and Frequency Error; Wanted, Error

3. Errors This field displays the number of bursts which could not be used as part of an overall calculation. This field is updated when the measurement is completed. When the measurement cycle is complete, this field will display the total number of unused bursts.

See Also Screens: Phase and Frequency Error; Wanted, Done

4. Meas Frequency This field displays the frequency at which measurements are being made. This field is only used in the TEST MODE.

5. ON/OFF This field enables or disables multi-burst measurement. The default for this field is **OFF**.

Choices **ON** enables multi-burst measurement.
OFF disables multi-burst measurement.

**6. Peak Phase
RMS
Frequency Error** These fields show the measurement results made during a measurement cycle when multi-burst is on. The table below explains each of the measurements made.

| Error | Mean | Maximum | Minimum | Last |
|-------------------|---|--|--|------------------------------------|
| Peak phase | Mean of the peak phase errors of each burst | Largest peak phase error in any of the bursts | Smallest peak phase error in any of the bursts | Peak phase error of the last burst |
| RMS phase | Mean of the RMS phase errors of each burst | Largest RMS phase error in any of the bursts | Smallest RMS phase error in any of the bursts | RMS phase error of the last burst |
| Frequency | Mean of the frequency errors of each burst | Most Positive frequency error in any of the bursts | Most Negative frequency error in any of the bursts | Frequency error of the last burst |

7. Single/Cont Single allows one test to be performed. Cont allows testing to automatically repeat.

Screens

Phase and Frequency Error - Multi-burst ON

- 8. Sync Status** This field displays any errors that occurred while trying to synchronize to the demodulated data.
See Also Making Measurements: Solving Problems Messages
- 9. Trig Delay** This field sets the time delay between a valid trigger event and the beginning of a measurement.
Range 0 to 5000.00 μ s.
- 10. View** This field selects alternate views of the measurement.

NOTE Selecting any of these alternate views, displays information relating to the **Last Burst Only**.

Choices Phase Err
Data Bits
- 11. Wanted** This field defines the number of bursts to be measured during a measurement cycle. The default value is 10.
Range 1 to 999

Phase/Freq, Phase Err

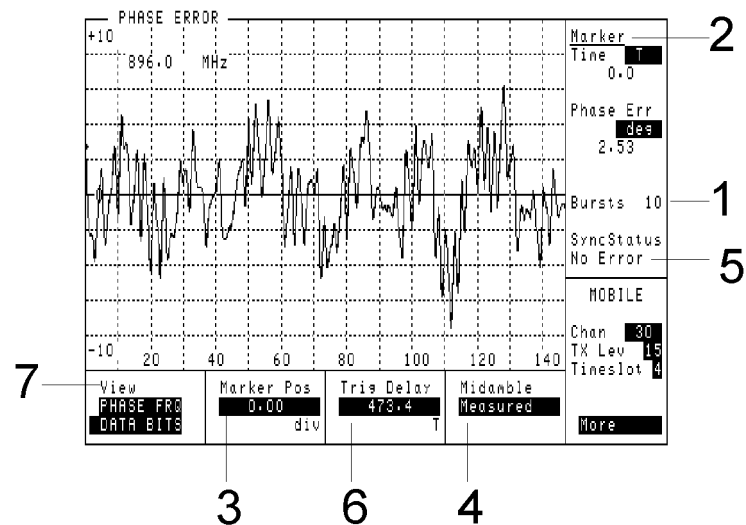

This view displays phase error versus time. The vertical range is scaled to the measurement. The horizontal range is 0 to 147 or 0 to 87 bit periods depending on the burst type.

NOTE

When multiburst is turned on, display update rate for power versus time and phase traces will be slowed down while multiple bursts are collected.

1. Bursts

This field is only shown when multi-burst is ON. It shows the burst count setting.

2. Marker

This field displays the marker position in time relative to bit 0 of the received burst.

3. Marker Pos

This field sets the position on the trace that phase error will be measured and displayed. The marker position is settable in units of division (div) only.

Screens

Phase/Freq, Phase Err

4. Midamble

This field provides the option of specifying the bits used for calculating an ideal phase trajectory. (The DSP Analyzer calculates the ideal phase trajectory, then compares it with the transmitted signal's phase trajectory to determine phase and frequency error).

Choices **Expected** causes the DSP Analyzer to calculate the ideal phase trajectory using the bits displayed on the Meas Sync screen. This field is called Midamble or User Defined Sync Pattern, depending on which Burst Type is chosen.
Measured causes the DSP Analyzer to calculate the ideal phase trajectory based entirely on demodulated data bits.

NOTE

When measuring noisy signals (approx 10 deg rms), define your entire burst as a User Defined Sync Pattern, and select Expected. This will eliminate the problem of bit errors causing gross peak phase errors.

See Also Screens: Measurement Sync

5. SyncStatus

This field displays any errors that occurred while trying to synchronize to the demodulated data.

See Also Making Measurements: Solving Problems Messages

6. Trig Delay

This field sets the time delay between a valid trigger event and the beginning of a measurement.

Range 0 to 5000.00 μ s.

7. View

This field selects alternate views of the measurement.

Choices Phase Main
Data Bits

Phase/Freq, Data Bits

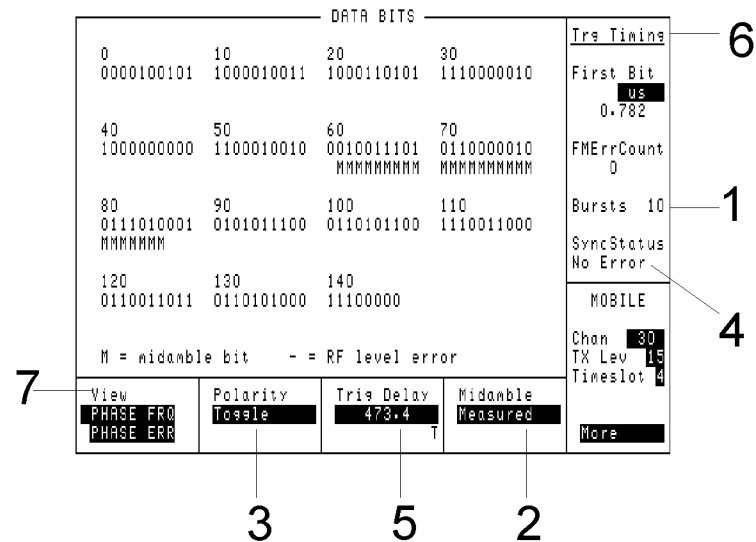

This screen displays the measured demodulated data bits and tags indicating how each bit was interpreted by the measurement.

NOTE

When multiburst is turned on, display update rate for power versus time and phase traces will be slowed down while multiple bursts are collected.

1. Bursts

This field is only shown when multi-burst is **ON**. It shows the burst count setting.

2. Midamble

This field provides the option of specifying the bits used for calculating an ideal phase trajectory. (The DSP Analyzer calculates the ideal phase trajectory, then compares it with the transmitted signal's phase trajectory to determine phase and frequency error).

Choices

Expected causes the DSP Analyzer to calculate the ideal phase trajectory using the bits displayed on the Meas Sync screen. This field is called Midamble or User Defined Sync Pattern, depending on which Burst Type is chosen.

Measured causes the DSP Analyzer to calculate the ideal phase trajectory based entirely on demodulated data bits.

NOTE When measuring noisy signals (approx 10° rms), define your entire burst as a User Defined Sync Pattern, and select Expected. This will eliminate the problem of bit errors causing gross peak phase errors.

See Also Screens: Measurement Sync

3. Polarity This field toggles the polarity of the displayed bits.

4. SyncStatus This field displays any errors that occurred while trying to synchronize to the demodulated data.

See Also Making Measurements: Solving Problems Messages

5. Trig Delay This field sets the time delay between a valid trigger event and the beginning of a measurement.

Range 0 to 5000.00 μs.

6. Trg Timing This First Bit field displays the position in time of the first useful bit relative to the delayed measurement trigger.

See Also Keys: ON/OFF, HI LIMIT, LO LIMIT, REF SET, AVG, Units

The FMErr Count field displays the number of bit differences detected when comparing the demodulated data bits to the selected midamble or user defined synchronization pattern when Sync Mode is set to Midamble. This field will display 0 if Sync Mode is set to Amplitude.

Screens: Measurement Sync (**Sync Mode**)

7. View This field selects alternate views of the measurement.

Choices Phase Frq
Phase Err

Pwr Ramp: Rise Edge

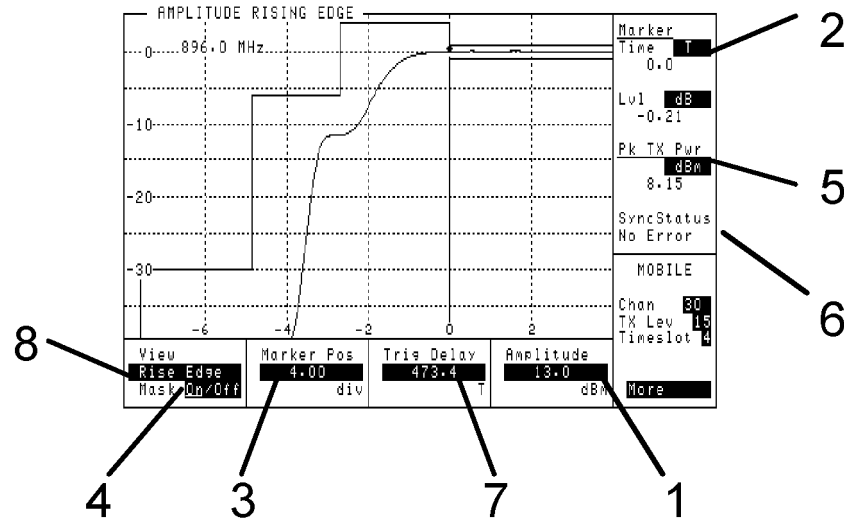

This view displays the rising portion of the amplitude envelope with the amplitude mask superimposed. The vertical range is -40 to +5 dB. The horizontal range is -8 to +4 bit periods.

NOTE

When multiburst is turned on, display update rate for power versus time and phase traces will be slowed down while multiple bursts are collected.

1. Amplitude

This is a copy of the RF analyzer Amplitude field. This is the amplitude to be assumed at the selected input port.

Range RF IN/OUT: -27.9 to +41.0 dBm. AUX RF IN: -58.0 to +20.0 dBm.

See Also Screens: RF Generator/RF Analyzer (RF Analyzer) Chapter 3: Specifications

2. Marker

These fields display the time and level at the current marker position.

3. Marker Pos

This field sets the marker position. The marker position is settable in units of division (div) only.

Screens

Pwr Ramp: Rise Edge

- 4. Mask** This field turns the amplitude mask on or off.
-
- NOTE** In PCS 1900 mode only (requires HP/Agilent 83220A/E) this field has three choices; Off, Narrow or Relax. Narrow refers to the old ETSI phase 1 power vs time mask. Relax refers to the new ETSI phase 11 power vs time mask where the specifications are relaxed at lower power levels.
-
- 5. Pk TX Pwr** This field displays the average power over the useful bits in the measured burst. It is measured from the center of the first useful bit to the center of the last useful bit.
- See Also** Keys: ON/OFF, HI LIMIT, LO LIMIT, REF SET, AVG, Units
- 6. SyncStatus** This field displays any errors that occurred while trying to synchronize to the demodulated data. During multi-burst measurement, this field indicates the measurement progress. When the measurement is complete, the SyncStatus is displayed.
- See Also** Making Measurements: Solving Problems, Messages
- 7. Trig Delay** This field sets the time delay between a valid trigger event and the beginning of a measurement.
- Range** 0 to 5000.00 μ s.
- 8. View** This field selects alternate views of the measurement.
- Choices** Rise Edge
Top 2 dB
Fall Edge
Summary
- If you have option 006 (spectrum analyzer) installed, you will also be offered the following measurement screens:
- Pulse
 - Puls Rise
 - Puls Fall
- Refer to Pwr Ramp:Pulse, Pwr Ramp:Pulse Rise, and Pwr Ramp:Pulse Fall screens for a description.

Pwr Ramp, Top 2 dB

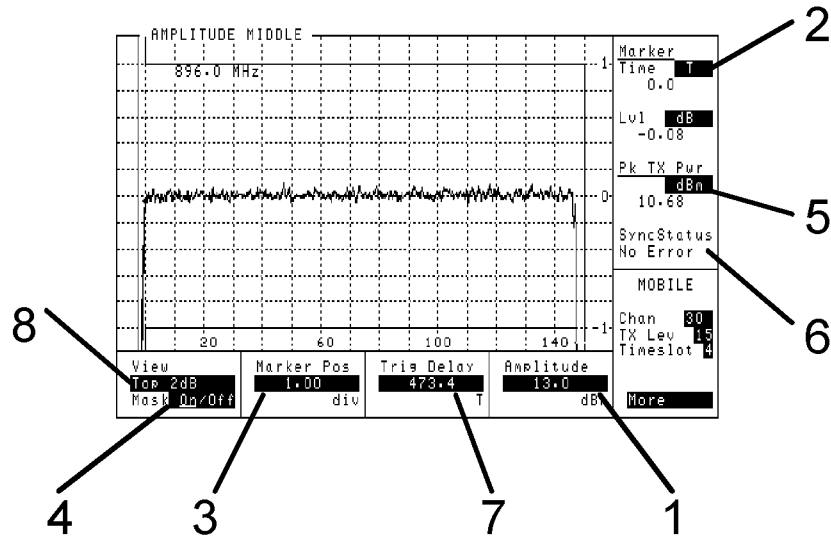

NOTE

When multiburst is turned on, display update rate for power versus time and phase traces will be slowed down while multiple bursts are collected.

This view displays the middle portion of the amplitude envelope with the amplitude mask superimposed. The vertical range is -1.2 to $+1.2$ dB. The horizontal range is -10 to $+160$ or -6 to $+96$ bit periods depending on the burst type.

1. Amplitude

This is a copy of the RF analyzer Amplitude field. This is the amplitude to be assumed at the selected input port.

Range RF IN/OUT: -27.9 to $+41.0$ dBm. AUX RF IN: -58.0 to $+20.0$ dBm.

See Also Screens: RF Generator/RF Analyzer (RF Analyzer) Chapter 3: Specifications

2. Marker

These fields display the time and level at the current marker position.

3. Marker Pos

This field sets the marker position. The marker position is settable in units of division (div) only.

Screens

Pwr Ramp, Top 2 dB

- 4. Mask** This field turns the amplitude mask on or off.
-
- NOTE** In PCS 1900 mode only (requires HP/Agilent 83220A/E) this field has three choices; Off, Narrow or Relax. Narrow refers to the old ETSI phase 1 power vs time mask. Relax refers to the new ETSI phase 11 power vs time mask where the specifications are relaxed at lower power levels.
-
- 5. Pk TX Pwr** This field displays the average power over the useful bits in the measured burst. It is measured from the center of the first useful bit to the center of the last useful bit. This measurement is only available when using the RF IN/OUT port.
- See Also** Keys: ON/OFF, HI LIMIT, LO LIMIT, REF SET, AVG, Units
- 6. SyncStatus** This field displays any errors that occurred while trying to synchronize to the demodulated data. During multi-burst measurement, this field indicates the measurement progress. When the measurement is complete, the SyncStatus is displayed.
- See Also** Making Measurements: Solving Problems Messages
- 7. Trig Delay** This field sets the time delay between a valid trigger event and the beginning of a measurement.
- Range** 0 to 5000.00 μ s.
- 8. View** This field selects alternate views of the measurement.
- Choices** Rise Edge
Top 2 dB
Fall Edge
Summary
- If you have option 006 (spectrum analyzer) installed, you will also be offered the following measurement screens:
- Pulse
 - Puls Rise
 - Puls Fall

Pwr Ramp, Fall Edge

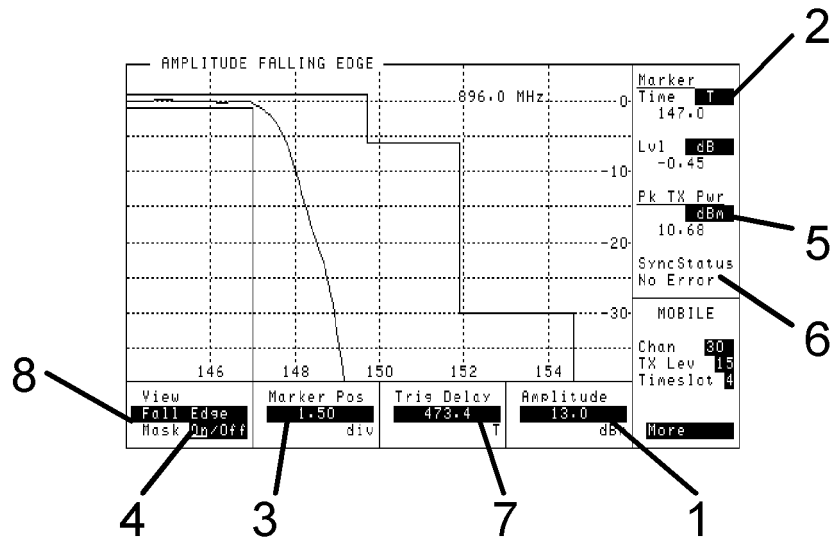

NOTE

When multiburst is turned on, display update rate for power versus time and phase traces will be slowed down while multiple bursts are collected.

This view displays the falling portion of the amplitude envelope with the amplitude mask superimposed. The vertical range is -40 to $+5$ dBm. The horizontal range is $+144$ to $+156$ or $+84$ to $+96$ bit periods depending on the burst type.

1. Amplitude

This is a copy of the RF analyzer Amplitude field. This is the amplitude to be assumed at the selected input port.

Range RF IN/OUT: -27.9 to $+41.0$ dBm. AUX RF IN: -58.0 to $+20.0$ dBm.

See Also Screens: RF Generator/RF Analyzer (RF Analyzer) Chapter 3: Specifications

2. Marker

These fields display the time and level at the current marker position.

Screens

Pwr Ramp, Fall Edge

- 3. Marker Pos** This field sets the marker position. The marker position is settable in units of division (div) only.
- 4. Mask** This field turns the amplitude mask on or off.
-
- NOTE** In PCS 1900 mode only (requires HP/Agilent 83220A/E) this field has three choices; Off, Narrow or Relax. Narrow refers to the old ETSI phase 1 power vs time mask. Relax refers to the new ETSI phase 11 power vs time mask where the specifications are relaxed at lower power levels.
-
- 5. Pk TX Pwr** This field displays the average power over the useful bits in the measured burst. It is measured from the center of the first useful bit to the center of the last useful bit. This measurement is only available when using the RF IN/OUT port.
- See Also** Keys: ON/OFF, HI LIMIT, LO LIMIT, REF SET, AVG, Units
- 6. SyncStatus** This field displays any errors that occurred while trying to synchronize to the demodulated data. During multi-burst measurement, this field indicates the measurement progress. When the measurement is complete, the SyncStatus is displayed.
- See Also** Making Measurements: Solving Problems Messages
- 7. Trig Delay** This field sets the time delay between a valid trigger event and the beginning of a measurement.
- Range** 0 to 5000.00 μ s.
- 8. View** This field selects alternate views of the measurement.
- Choices** Rise Edge
Top 2 dB
Fall Edge
Summary
- If you have option 006 (spectrum analyzer) installed, you will also be offered the following measurement screens:
- Pulse
 - Puls Rise
 - Puls Fall

Pwr Ramp: Summary

| AMPLITUDE : Summary | | | | | | | |
|---------------------|-------------|------------|------------|--------|----|------------|----------|
| Time1 | Ampl1 | dB | Time7 | Ampl7 | dB | Pk TX Pwr | dBm |
| -18.000000 | 0.00 | | 831.230760 | 0.00 | | 10.68 | |
| Time2 | Ampl12 | dB | Time8 | Ampl18 | dB | Flatness | dB |
| -10.000000 | 0.00 | | 839.230760 | 0.00 | | 0.00 | |
| Time3 | Ampl13 | dB | Time9 | Ampl19 | dB | Pk+: | dB |
| -5.000000 | 0.00 | | 542.769230 | 0.00 | | 0.00 | |
| Time4 | Ampl14 | dB | Time10 | Ampl10 | dB | Pk-: | dB |
| 0.000000 | 0.00 | | 547.769230 | 0.00 | | 0.00 | |
| Time5 | Ampl15 | dB | Time11 | Ampl11 | dB | SyncStatus | No Error |
| 821.230760 | 0.00 | | 552.769230 | 0.00 | | | |
| Time6 | Ampl16 | dB | Time12 | Ampl12 | dB | NOBILE | |
| 826.230760 | 0.00 | | 560.769230 | 0.00 | | | |
| View | Measurement | Trig Delay | Amplitude | | | Chan | 80 |
| Summary | Summary: | 473.4 | 13.0 | | | TX Lev | 15 |
| Pwr Zero | ---- | | dBm | | | Timeslot | 4 |

NOTE

When multiburst is turned on, display update rate for power versus time and phase traces will be slowed down while multiple bursts are collected.

1. Ampl1-12

These fields display the amplitude measured on the amplitude envelope at the corresponding time set in the Time1-12 fields.

See Also Keys: ON/OFF, HI LIMIT, LO LIMIT, REF SET, AVG, Units

2. Amplitude

This is a copy of the RF analyzer Amplitude field. This is the amplitude to be assumed at the selected input port.

Range RF IN/OUT: -27.9 to +41.0 dBm. AUX RF IN: -58.0 to +20.0 dBm.

See Also Screens: RF Generator/RF Analyzer, (RF Analyzer) Chapter 3: Specifications

Screens

Pwr Ramp: Summary

- 3. Flatness** This field displays the positive and negative amplitude peaks relative to the average power over the useful bits in the measured burst.
- **Pk+** peak, relative to the average power.
 - **Pk-** is the negative amplitude peak, relative to the average power.
- See Also** Keys: ON/OFF, HI LIMIT, LO LIMIT, REF SET, AVG, Units
- 4. Measurement Summary** This field displays whether HI/LO limits set for the measurement display fields, (Ampl1-12 and flatness) were exceeded in the last measurement.
- See Also** Making Measurements: Solving Problems, Messages
- 5. Pk TX Pwr** This field displays the average transmitted power over the useful bits in the measured burst. It is measured from the center of the first useful bit to the center of the last useful bit. This measurement is only available when using the RF IN/OUT port.
- See Also** Keys: ON/OFF, HI LIMIT, LO LIMIT, REF SET, AVG, Units
- 6. SyncStatus** This field displays any errors that occurred while trying to synchronize to the demodulated data. During multi-burst measurement, this field indicates the measurement progress. When the measurement is complete, the SyncStatus is displayed.
- See Also** Making Measurements: Solving Problems Messages
- 7. Time1-12** These fields select the time (relative to the center of bit zero) the amplitude will be measured on the amplitude envelope. Bit zero is the first useful bit in the measured burst.
- Range** -50.0 to +593.0 μ s.
- 8. Trig Delay** This field sets the time delay between a valid trigger event and the beginning of a measurement.
- Range** 0 to 5000.00 μ s.

9. View

This field selects alternate views of the measurement.

Choices Rise Edge
 Top 2 dB
 Fall Edge
 Summary

If you have option 006 installed, you also have access to the following

- Pulse
- Puls Rise
- Puls Fall

10. ZeroPower

This field zeros the power meter. RF power must be disconnected from the RF IN/OUT port when executing this function.

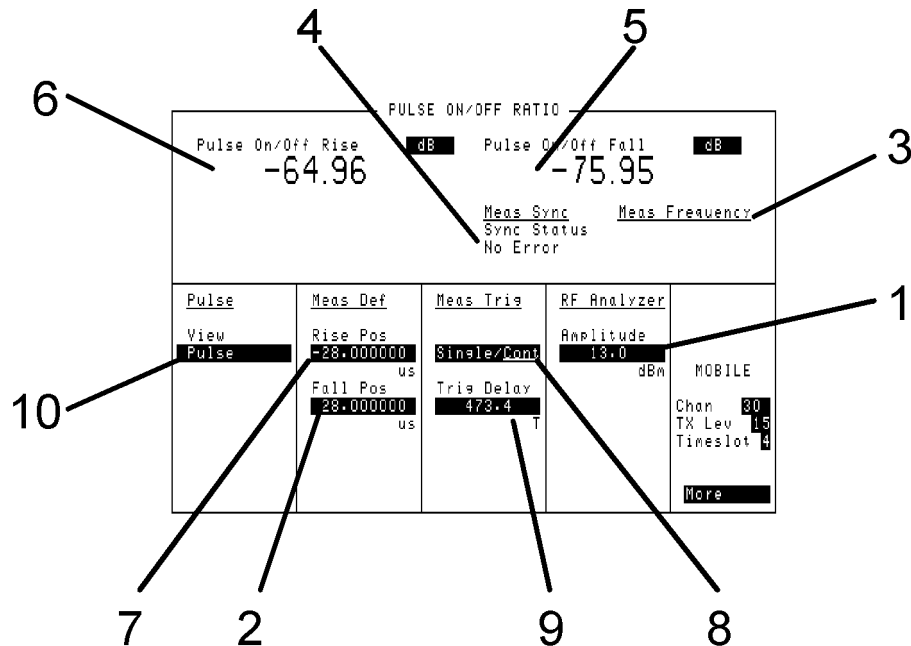
Pwr Ramp: Pulse (Option 006 Only)
**1. Amplitude**

This is a copy of the RF Analyzer Amplitude field. This is the amplitude to be assumed at the selected input port.

Range RF IN/OUT: -27.9 to +41.0 dBm. AUX RF IN: -58.0 to +20.0 dBm.

See Also Screens: RF Generator/RF Analyzer, (RF Analyzer) Chapter 3: Specifications

2. Fall Pos

This field selects the time (relative to the center of the last bit) that the amplitude on the amplitude envelope will be measured.

Range 0.0 μ s to +56 μ s.

3. Meas Frequency

This field displays the frequency at which measurements are being made (Test Mode only).

- 4. Meas Sync (Sync Status)** This field displays any errors that occurred while trying to synchronize to the demodulated data.
See Also Making Measurements: Solving Problems Messages
- 5. Pulse On/Off Fall** This field displays the measured amplitude at the fall-position time relative to the average On power over the useful bits in the measured burst.
See Also Keys: ON/OFF, HI LIMIT, LO LIMIT, REF SET, AVG, METER, Units
-
- NOTE** The Pulse On/Off Ratio measurement requires the use of measurements on three bursts: the first is to establish the reference amplitude level of the burst, the second is to measure the rise portion of the burst, and the third is to measure the fall portion of the burst. Between the measurements the analyzer amplitude and trigger delay is internally changed for the following measurement. Since RF Rise triggering is based on a variable rising edge of the incoming signal, the measurement result cannot be considered valid, unless the burst timing is consistent.
-
- NOTE** When the Test Mode or CW Generator mode is selected on the cell control screen, the RF rise trigger is automatically selected.
-
- 6. Pulse On/Off Rise** This field displays the measured amplitude at the rise-position time relative to the average On power over the useful bits in the measured burst.
See Also Keys: ON/OFF, HI LIMIT, LO LIMIT, REF SET, AVG, METER, Units
- 7. Rise Pos** This field selects the time (relative to the center of bit zero) that the amplitude on the amplitude envelope will be measured.
Range -56.0 μ s to 0.0 μ s.
- 8. Single/Cont** Single allows one test to be performed. Cont allows testing to automatically repeat.

Screens

Pwr Ramp: Pulse (Option 006 Only)

9. Trig Delay This field sets the time delay between a valid trigger event and the beginning of a measurement.

Range 0 to 5000.00 μ s

10. View This field selects the alternate Views of the Pulse On/Off Ratio measurement.

Choices Rise Edge
Top 2 dB
Fall Edge
Summary

Pwr Ramp: Pulse Rise (Option 006 Only)

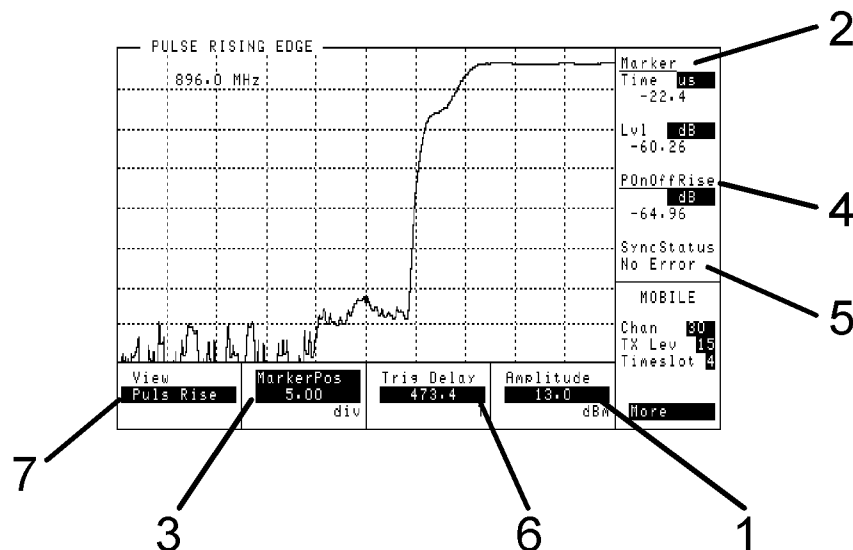

This view displays Pulse On/Off power spectral density versus time for the rising portion of the burst.

1. Amplitude

This is a copy of the RF Analyzer Amplitude field. This is the amplitude to be assumed at the selected input port,

Range RF IN/OUT: -27.9 to +41.0 dBm. AUX RF IN: -58.0 to +20.0 dBm.

See Also Screens: RF Generator/RF Analyzer, (RF Analyzer) Chapter 3: Specifications

2. Marker

This field displays the level at the current marker position.

See Also Keys: ON/OFF, HI LIMIT, LO LIMIT, REF, AVG, Units

3. MarkerPos

This field selects the marker position for the rising trace.

Choices MarkerPos
Rise Pos

Screens

Pwr Ramp: Pulse Rise (Option 006 Only)

4. POnOffRise This field displays the measured amplitude at the rise-position time relative to the average On power over the useful bits in the measured burst.

See Also Keys: ON/OFF, HI LIMIT, LO LIMIT, REF SET, Units

5. SyncStatus This field displays any errors that occurred while trying to synchronize to the demodulated data.

See Also Making Measurements: Solving Problems Messages

6. Trig Delay This field sets the time delay between a valid trigger event and the beginning of a measurement.

Range 0 to 5000.00 μ s

7. View This field selects the alternate Views of the Pulse On/Off Ratio measurement.

Choices Rise Edge
Top 2 dB
Fall Edge
Summary

Pwr Ramp: Pulse Fall (Option 006 Only)

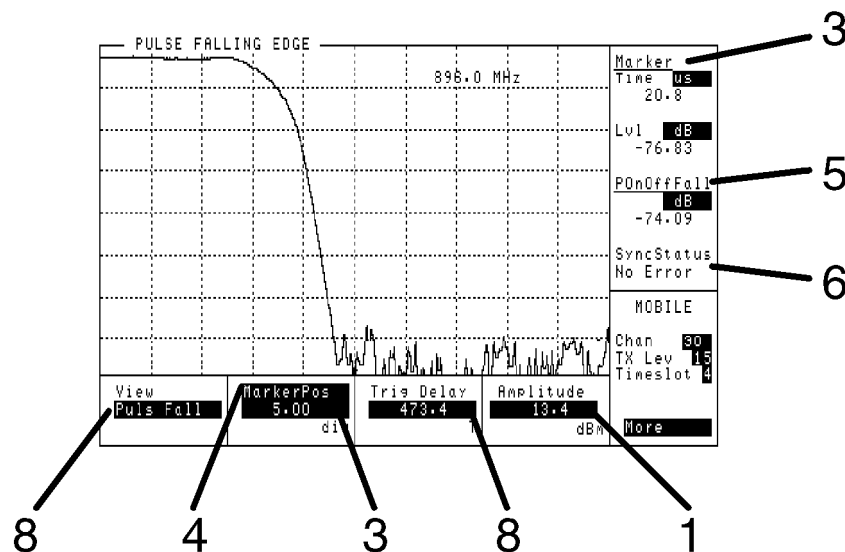

This view displays Pulse On/Off power spectral density versus time for the falling portion of the burst.

1. Amplitude

This is a copy of the RF Analyzer Amplitude field. This is the amplitude to be assumed at the selected input port,

Range RF IN/OUT: -27.9 to +41.0 dBm. AUX RF IN: -58.0 to +20.0 dBm.

See Also Screens: RF Generator/RF Analyzer, (RF Analyzer) Chapter 3: Specifications

3. Marker

This field displays the level at the current marker position.

See Also Keys: ON/OFF, HI LIMIT, LO LIMIT, REF, AVG, Units

Screens

Pwr Ramp: Pulse Fall (Option 006 Only)

- 3. MarkerPos** This field selects the marker position for the rising trace.
- Choices** MarkerPos
Fall Pos
- Range** 0.0 to +56.0 μ s
- 4. POnOffFall** This field displays the measured amplitude at the fall-position time relative to the average On power over the useful bits in the measured burst.
- 5. SyncStatus** This field displays any errors that occurred while trying to synchronize to the demodulated data.
- See Also** Making Measurements: Solving Problems Messages
- 6. Trig Delay** This field sets the time delay between a valid trigger event and the beginning of a measurement.
- Range** 0 to 5000.00 μ s
- 7. View** This field selects the alternate Views of the Pulse On/Off Ratio measurement.
- Choices** Rise Edge
Top 2 dB
Fall Edge
Summary

RF Generator / RF Analyzer (AF Gen)

| RF GENERATOR / RF ANALYZER | | | | |
|---|--|---|---|---|
| RF Gen Frequency Hopped RF Output RF IN/OUT | RF Gen Amplitude -64.0 dBm Atten Hold On/Off | Mod Source QMSK Ext DC AM OFF Pulse Mod Triv Normal | RF Gen Mod Control Mod Mode Non-Mod/Mod Mod Triv Stop/Disarm | AF Gen Frequency 1.0000 kHz Amplitude 50.0 mV Coupling AC/DC |
| RF Analyzer Hse Offset 0.0000 kHz RF Input RF IN/OUT NonHess/Freq 0.000000 MHz | RF Analyzer Amplitude 12.0 dBm Control Manual Accuracy +-3dB | AGC AGC Mode Auto Sweep/Auto SRC Value 99 | RF Analyzer Mod Control Mod Mode Non-Mod/Mod Mod Triv Stop/Disarm | To Screen PHASE FRO PWR RAMP BIT ERROR OUT RF SP None |

1. Amplitude

This field is the AF Generator Audio Out amplitude setting.

Range 0.0 mV rms to 8.84 V rms.

2. Coupling

This field selects ac or dc coupling of the AF Generator Audio Out signal.

3. Frequency

This field is the AF Generator Audio Out Frequency setting.

Range dc to 30 kHz.

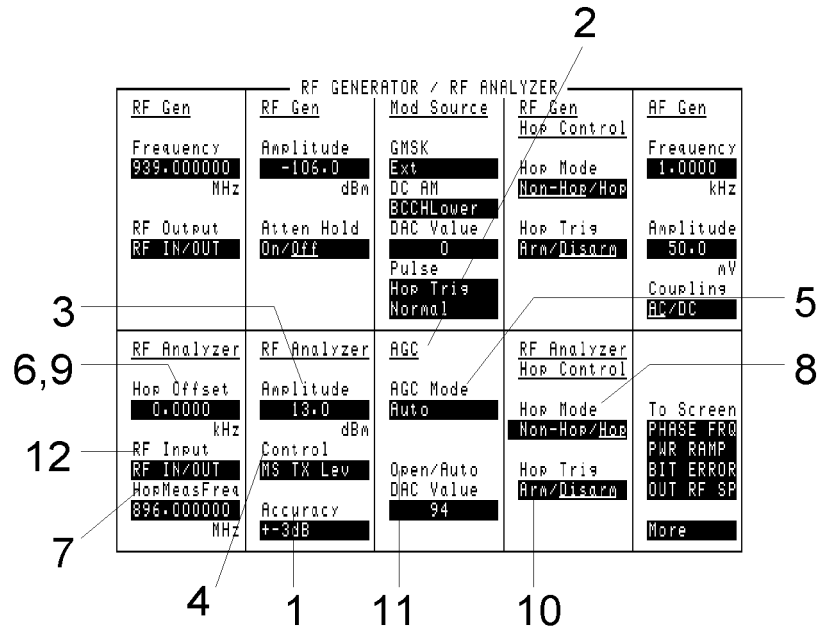
RF Generator / RF Analyzer (RF Analyzer)
**1. Accuracy**

This field selects the input accuracy of the RF Amplitude setting to be assumed by the instrument for setting the Open/Auto DAC Value when in Auto AGC mode.

Choices +3 dB
 +-1 dB

2. AGC Mode

This field selects the AGC Mode.

Choices **Closed** is closed-loop AGC operation. It is used for stable, repeating RF signals and provides greater accuracy measurements.
 Open is used for isolated pulses, for example RACHs.
 Auto is used to automatically set the Open/Auto DAC Value based on the entered amplitude and accuracy.

- 3. Amplitude** This field is the input amplitude to be assumed at the selected RF Analyzer input. The amplitude shown is for the port selected in the RF Input field.
- Range** RF IN/OUT: -27.9 to +41.0 dBm. AUX RF IN: -58.0 to +20.0 dBm.
- See Also** Chapter 3: Specifications
- 4. Control** This field determines how the RF Analyzer amplitude is selected.
- Choices** **MS TX Lev** automatically selects the RF Analyzer amplitude based on the level set in TX Level on the Cell Control screen if the RF analyzer's RF input connector selection is RF IN/OUT. **Manual** requires setting the RF Analyzer amplitude using the front-panel keys.
- 5. Do Open Cal** This field is displayed only when AGC Mode is closed. When selected, the correct Open/Auto DAC Value for the signal input, using the present RF Analyzer setting, is entered in the Open/Auto Dac Value field.
- A stable, repeating RF signal is required for open loop calibration.
- Doing an open loop calibration is useful for establishing an AGC DAC Value to be used when AGC Mode is Open.
- See Also** Screens: RF Analyzer (AGC Mode, Open/Auto DAC Value)
- 6. Frequency** This field sets Frequency when RF Analyzer Hop Mode is set to Non- Hop.
- Range** 10.0 to 1015.0 MHz.
- 7. Hop Meas Freq** This is the frequency entry field for the frequency assumed when making measurements while the RF Analyzer is frequency hopping.
- 8. Hop Mode** This field selects between the Hop and Non-Hop modes of the RF Analyzer. Hop Mode cannot be set to Non-Hop until Hop Trig is set to Disarm.
-
- NOTE** Do not make measurements with Hop Mode set to **Hop** and Hop Trig set to **Disarm**.
-
- 9. Hop Offset** This field sets the Hop Offset when the RF Analyzer Hop Mode is set to Hop. The frequency offset is applied to all of the frequencies in the RF Analyzer Hop Frequency table when the RF Analyzer is hopping.
- Range** -50.000 to +50.000 kHz.

Screens

RF Generator / RF Analyzer (RF Analyzer)

10. Hop Trig This field selects whether the RF Analyzer is armed or disarmed to accept a hop trigger. Hop Trig cannot be set to Arm until Hop Mode is set to Hop.

NOTE Do not make measurements with Hop Trig set to **Disarm** and Hop Mode set to **Hop**.

11. Open/Auto DAC Value This field is the AGC level DAC value when in Open or Auto AGC mode. This value can be entered automatically by choosing Auto AGC Mode. It can also be entered by performing a Do Open Cal operation while in Open AGC mode, or manually while in Open or Closed AGC Mode.

During Auto operation, the DAC value is based on the RF Analyzer Amplitude setting, and will be updated each time RF Analyzer Amplitude is changed.

See Also Screens: RF Analyzer (Do Open Cal, AGC Mode)

Range 0 to 255.

12. RF Input This field selects the RF input port for the RF Analyzer.

Choices RF IN/OUT
AUX RF IN

Range RF IN/OUT: -27.9 to +41.0 dBm. AUX RF IN: -58.0 to +20.0 dBm.

RF Generator / RF Analyzer (RF Gen)

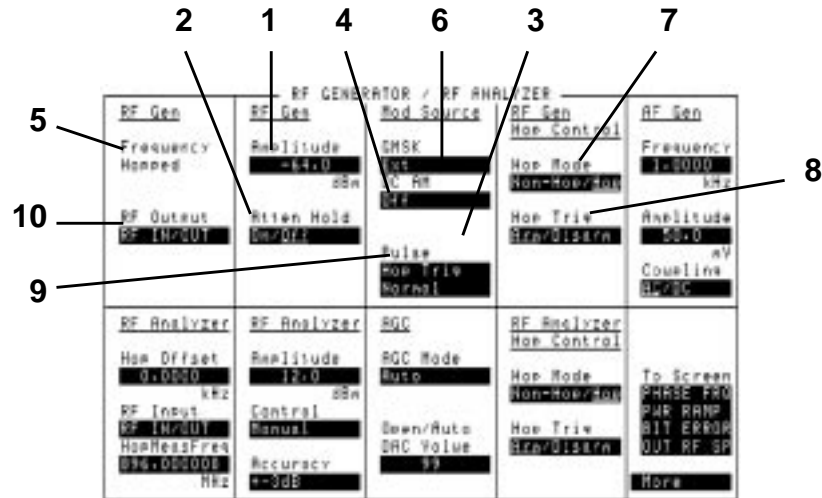

1. Amplitude

This is the amplitude entry field. The amplitude shown is for the port selected in the RF Output field.

Range RF IN/OUT: -127.0 to -7.0 dBm. AUX RF OUT: -127.0 to $+10.0$ dBm.

See Also Chapter 3: Specifications

2. Atten Hold

This field prevents attenuator switching when On is selected.

3. DAC Value

This field allows the DC AM modulation level to be set through the modulation source DAC.

Range 0 through 255

Screens

RF Generator / RF Analyzer (RF Gen)

4. DC AM This field selects the status of DC AM. When the instrument mode is Activated (see Screens: Cell Configuration), the broadcast and traffic channels' amplitude can be lowered using choices in this field.

- Choices**
- Ext** turns on the front-panel input for DC AM.
 - Off** turns off DC AM.
 - TCH Lower** reduces the TCH amplitude by a level determined by DAC Value.
 - BCCH Lower** reduces the BCCH amplitude by a level determined by DAC Value.
 - Both Lower** reduces the TCH and BCCH amplitude by a level determined by DAC Value.

See Also Screens: RF Generator / RF Analyzer, (Mod Source **DAC Value**) Screens: Cell Configuration

5. Frequency This is the non-hopped frequency entry field. When the RF Gen, Hop Control, Hop Mode is set to Hop, this field will show the frequency status as Hopped.

Range 10.0 to 1015.0 MHz.

6. GMSK This field turns on the input for external GMSK modulation. When Activated (see Screens: Cell Configuration), Ext is connected to internally generated signals.

- Choices**
- Ext
 - Off

7. Hop Mode This field selects between the Hop and Non-Hop modes of the RF Generator.

NOTE Do not make measurements with Hop Mode set to **Hop** and Hop Trig set to **Disarm**.

8. Hop Trig This field selects whether the RF Generator is armed or disarmed to accept a hop trigger.

NOTE Do not make measurements with Hop Trig set to Disarm and Hop Mode set to Hop.

9. Pulse

This field selects pulse modulation and triggering. When Activated (see Screens: Cell Configuration) these signals are internally generated.

Choices

Off turns pulse modulation off.

Hop Trig automatically pulses the RF Generator off for one timeslot at a valid hop trigger.

Ext allows the pulse signal to be input from the MODULATION IN PULSE connector or pin 6 (PULSE_MOD_IN) on the SYSTEM BUS connector.

Normal and Ext pulses the RF signal >80 dB below the RF Generator Amplitude setting when a TTL low is present. And, when a TTL high is present, the RF Generator output is at the set Amplitude.

Normal and Hop Trig pulses the RF signal >80 dB below the RF Generator Amplitude setting for one timeslot at a hop trigger.

30 dB and EXT pulses the RF Generator output 30 dB *above* the RF Generator Amplitude setting, when a TTL high is present. And, when a TTL low is present, the RF Generator output is at the set RF Amplitude.

30 dB and Hop Trig pulses the RF Generator output down 30 dB to the set Amplitude for one timeslot on a hop trigger.

10. RF Output

This field selects the RF output port.

Choices

RF IN/OUT

AUX RF OUT

Range

RF IN/OUT: -127.0 to -7.0 dBm. AUX RF OUT: -127.0 to +10.0 dBm.

Service



This screen is documented in the service documentation.

To escape, press **PREV**.

SMS Cell Broadcast

The screenshot shows the 'SMS CELL BROADCAST' configuration screen. It is divided into several sections:

- Top Section:** 'Messages To Send' (No Message), 'Message Broadcast' (Disabled/Enabled), and 'Broadcast Status' (Idle).
- Message 1 Section:** 'Code' (0), 'Update Number' (0), 'Identifier' (0), 'Language' (English), and 'Contents' (This is a test of the Short Message Service).
- Message 2 Section:** 'Code' (4095), 'Update Number' (15), 'Identifier' (0), 'Language' (German), and 'Contents' (15 pages containing the entire GSM alphabet. ie: Page 1: Page 2: Page 14: Page 15:).
- Message Fields Section:** 'Basic/All'.
- To Screen Section:** PHASE FRQ, PWR RAMP, BIT ERROR, OUT RF SP, and More.

Numbered callouts point to the following fields:

- 1: Broadcast Status
- 2: Code
- 3: Identifier
- 4: Language
- 5: Messages To Send
- 6: Message Fields
- 7: Title (SMS CELL BROADCAST)
- 8: Contents

- 1. Broadcast Status** This field indicates whether there is a valid ("Sending") or invalid ("Idle") message being sent on the cell broadcast channel (CBCH). This field switches to Sending when a valid message is being sent. The "Off" status indicates that a CBCH is not configured.
- 2. Code** This field identifies the particular message to be sent. The default for message 1 is 0. The default for message 2 is 4095.
Range 0 to 4095.
- 3. Identifier** This field selects the source and type of message. The default for message 1 is 0. The default for message 2 is 0.
Range 0 to 65535.

4. Language

This field selects the data coding scheme used for the message. “Default GSM” sets the value of the data coding scheme to 0xF0. The default for message 1 is “English”. The default for message 2 is “German”.

- Choices**
- German
 - English
 - Italian
 - French
 - Spanish
 - Dutch
 - Swedish
 - Danish
 - Portuguese
 - Finnish
 - Norwegian
 - Greek
 - Turkish
 - Default GSM

5. Message Broadcast

This field can be toggled between Enabled and Disabled. The default state is Disabled, when in the Enabled state, the system information 4 element on the BCCH indicates that an SD/4 configured CBCH is present. The CBCH is being sent using the messages indicated in the Messages To Send field.

NOTES

If Enabled is selected and the protocol reports any errors, for example, the BCH is not configured as SD/4, an error is produced and the status returns to disabled. In this example, the message “BCH must be activated as SD/4 CBCH has been disabled.” appears.

Whilst this field is set to Enabled and the Broadcast Status field is displaying Sending you cannot change any of the message attribute fields. If you attempt to change a field the message “Cannot change message parameters while broadcasting message” appears.

-
- Choices**
- Enabled
 - Disabled

6. Message Fields This field can be toggled between Basic and All. In the default state, Basic, the only message attribute which is editable is Identifier. All other attributes remain at their previously selected values and disappear from the screen. When All is selected, all of the message attributes are editable.

Choices Basic
 All

7. Messages To Send This field allows you to select which messages are to be sent. The default, **No Message** indicates the CBCH is sending invalid messages; **Message 1** sends the contents of Message 1 every 30 seconds; **Message 2** sends the contents of **Message 2** every 60 seconds; and **Messages 1 & 2** alternatively sends the contents of Message 1 and Message 2, with a 60 second interval between successive messages. To send a message immediately, simply select any choice other than **No Message**.

Choices No Message
 Message 1
 Message 2
 Messages 1 & 2

8. Update Number This field allows you to select the revision of the message to be sent. The default for Message 1 is 0, and the default for Message 2 is 15.

Range 0 to 15.

Spectrum Analyzer, Main Controls (Option 006 Only)

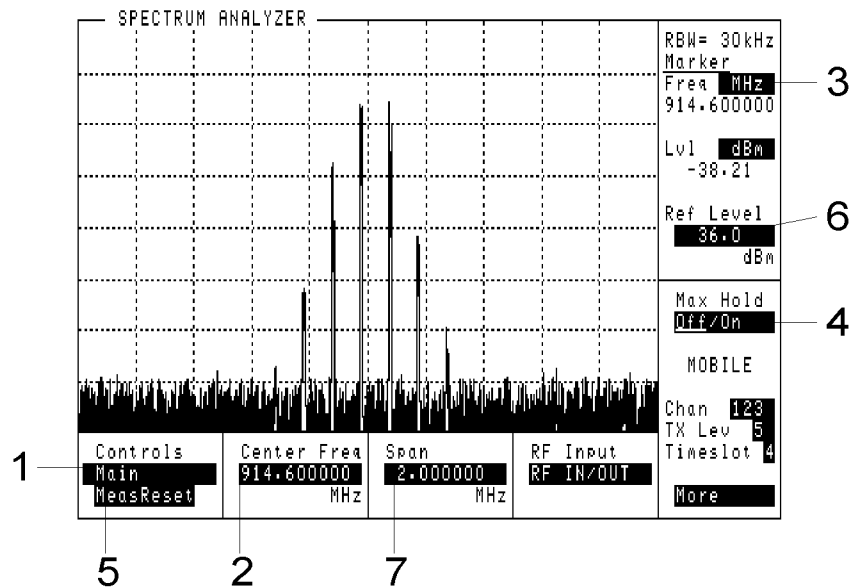

This screen displays the Spectrum Analyzer power spectral density versus frequency trace.

IMPORTANT

When Reference is set to Tunable (see Configure screen) and Offset is $\neq 0$ ppm, the frequency calibration of the Spectrum Analyzer will be inaccurate. This also affects RF Analyzer outputs such as FM DEMOD OUT, DSP Analyzer frequency measurement results, Phase, and Output RF Spectrum.

1. Controls

This field selects the alternate Controls of the Spectrum Analyzer measurement.

Choices

- Main
- RF Gen
- Marker
- Auxiliary

- 2. Center Freq** This field sets the center frequency when the RF Analyzer's Hop Mode is set to Non-Hop.
Range 10.0 to 1015.0 MHz.
- 3. Marker** The two fields display the frequency and the level at the current marker position.
See Also Keys: ON/OFF, HI LIMIT, LO LIMIT, REF SET, AVG, Units
- 4. Max Hold**
- 5. Meas Reset** Selecting Meas Reset will erase any accumulated measurements used for calculating a final result, and re-start the measurement process for the following functions:
- HI LIMIT
 - LO LIMIT
 - AVG
- See Also** Keys: HI LIMIT, LO LIMIT, AVG
- 6. Ref Level** This field is the reference level entry field for the selected RF input port.
Range RF IN/OUT: -18.9 dBm to +44.0 dBm. AUX RF IN: -55.0 dBm to +23.0 dBm.
- 7. Span** This field sets the frequency span.
Range 5 kHz to 4 MHz (overrange to 10 MHz).

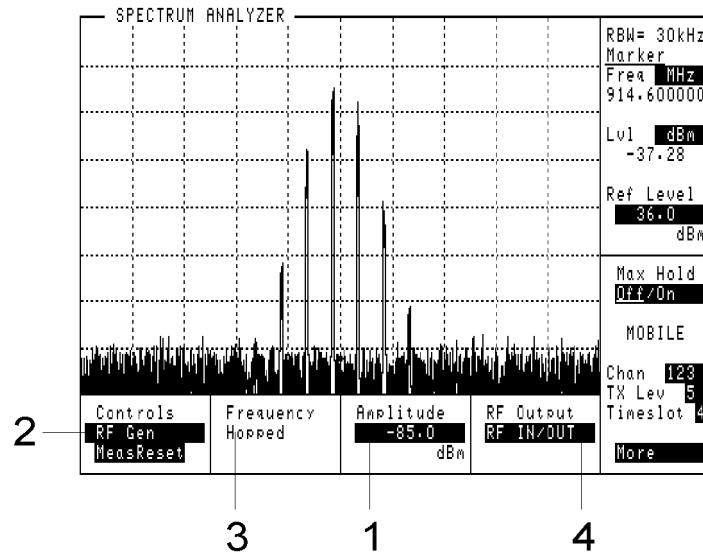
Spectrum Analyzer, RF Gen Controls (Option 006 Only)
**1. Amplitude**

This field sets the RF generator's amplitude. The amplitude shown is for the port selected in the RF Output field.

Range RF IN/OUT: -127.0 to -6.0 dBm. AUX RF OUT: -127.0 to +14.0 dBm.

2. Controls

This field selects the alternate Controls of the Spectrum Analyzer measurement.

Choices Main
RF Gen
Marker
Auxiliary

3. Frequency

This field sets the non-hopped frequency; or if the RF Gen, Hop Control, Hop Mode is set to Hop, this field will show the frequency status as Hopped.

Range 10.0 to 1015.0 MHz.

4. Marker

This field displays the frequency and the level of the current marker position.

Spectrum Analyzer, Marker Controls (Option 006 Only)

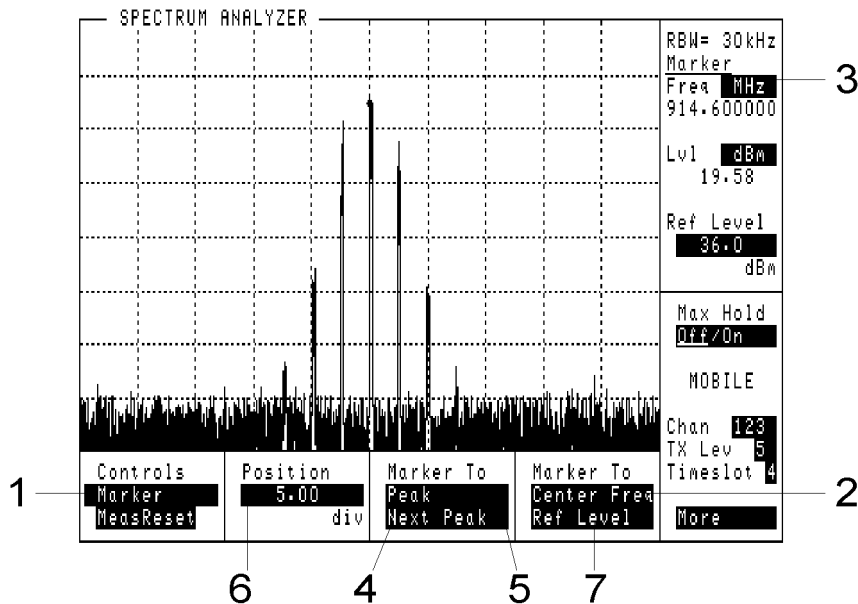

1. Controls

This field selects the alternate Controls of the Spectrum Analyzer measurement.

Choices

- Main
- RF Gen
- Marker
- Auxiliary

2. Center Freq (Marker To)

This field changes the center frequency setting to the frequency at the marker position.

3. Marker

This field displays the frequency and the level at the current marker position.

4. Next Peak (Marker To)

This field moves the marker to the next amplitude peak to the right of the current marker position.

5. Peak (Marker To)

This field moves the marker to the highest amplitude point on the trace.

Screens

Spectrum Analyzer, Marker Controls (Option 006 Only)

- 6. Position** This field sets the Marker Position for the trace.
Range 0 to 10 divisions.
- 7. Ref Level (Marker To)** This field changes the Ref Level setting to the level at the marker position.

Spectrum Analyzer, Auxiliary Controls

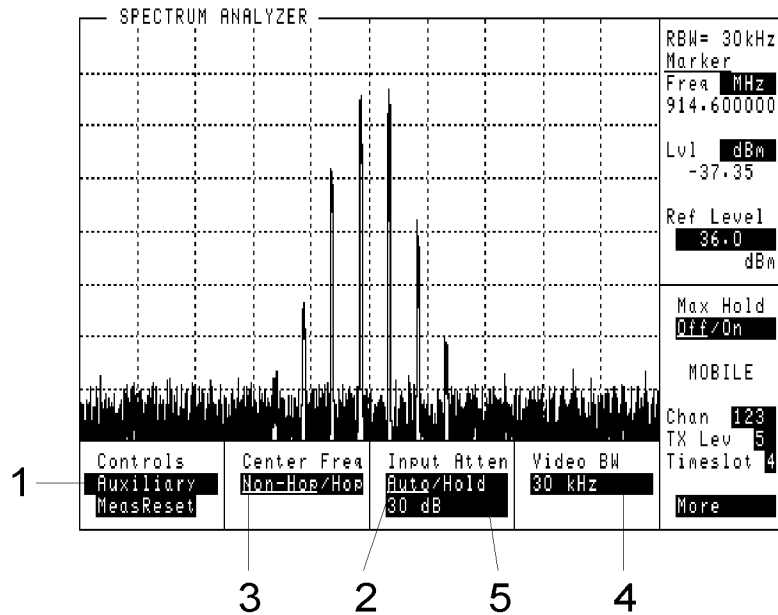

1. Controls

This field selects the alternate Controls of the Spectrum Analyzer measurement.

Choices

- Main
- RF Gen
- Marker
- Auxiliary

2. Auto Hold (Input Atten)

This field selects the Input Attenuator mode or value. The list of choices depends on the Radio Type selected on the Configure screen (GSM900, E-GSM, DCS1800 or PCS1900).

See Also Screens: Configure (**Radio Type**)

Screens

Spectrum Analyzer, Auxiliary Controls

3. RF Input

This field selects the RF input port for the spectrum analyzer.

Choices RF IN/OUT
AUX RF IN

Range RF IN/OUT: -27.9 to +41.0 dBm. AUX RF IN: -58.0 to +20.0 dBm.

4. Video BW

The video bandwidth field can be set to one of three settings:

- 30 kHz
- 100 kHz
- 1 MHz

5. 0 dB (Input Atten) Choices (GSM900, E-GSM, DCS 1800 and PCS 1900)

Auto selects the input attenuation automatically.

Hold allows the input attenuation to be changed manually.

0 dB

10 dB

20 dB

30 dB

40 dB

Tests

| TESTS | |
|--|--|
| Procedure: <input type="text" value="ROM"/> Location: <input type="text" value="ROM"/> Library: <input type="text" value=""/> Program Autostart: <input type="text" value="OFF/ON"/> | <input type="button" value="Run Test"/> <input type="button" value="Continue"/> <input type="button" value="Edit Spec"/> <input type="button" value="Edit Param"/> <input type="button" value="Edit Param"/> |
| Connect: <input type="text" value=""/> | |
| Test Execution Conditions | |
| On UUT Failure: <input type="text" value="Continue/Stop"/> | Run Mode: <input type="text" value="Continuous/Single Step"/> |
| Output Results: <input type="text" value="All Failures"/> | Output Destination: <input type="text" value="Printer"/> |
| Output Headline: <input type="text" value=""/> | Choices: <input type="text" value="Card"/> <input type="text" value="ROM"/> <input type="text" value="RAM"/> <input type="text" value="Disk"/> |
| Test Function: <input type="button" value="Edit Spec"/> | |

Instrument BASIC Refer to chapter 8, *Instrument BASIC* for information about the Tests Screen.

Screens
Tests

Keys

Key Map

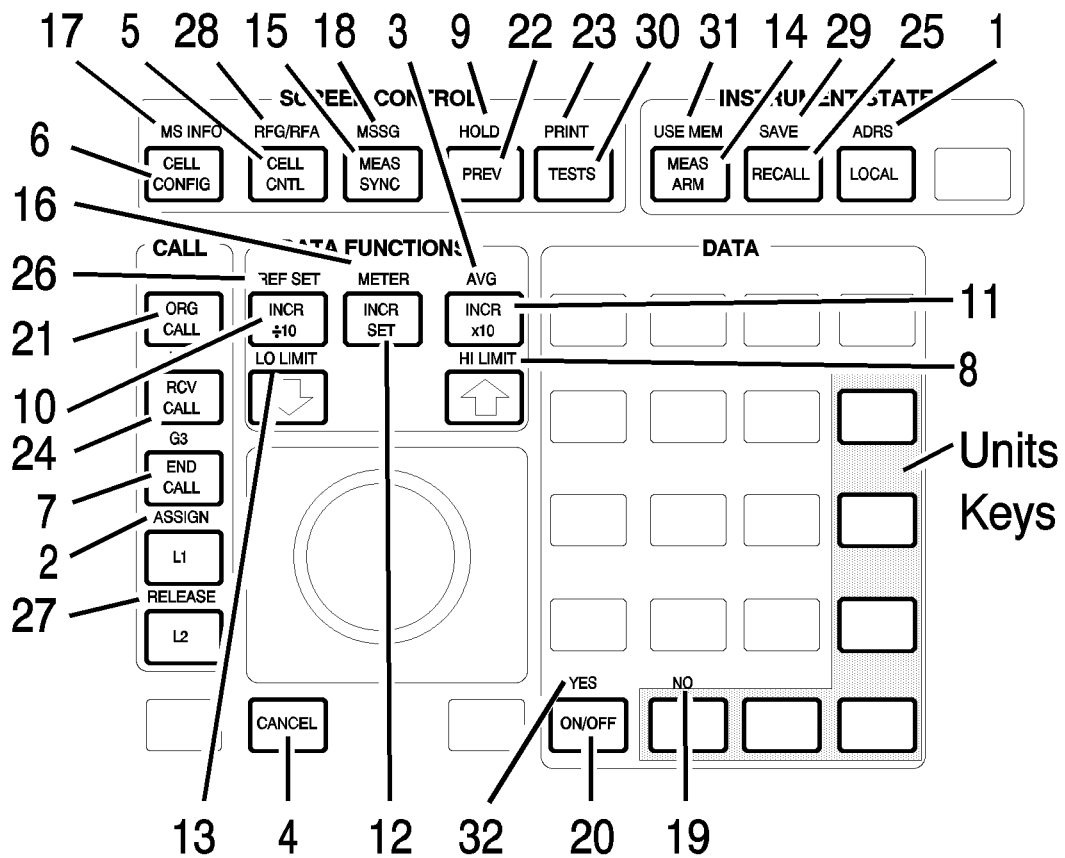

Function Keys

- 1. ADRS** This key is used to display the GPIB address.
- See Also**
Screens: Config
- 2. ASSIGN** This key is used to assign global (G1, G2, G3) and local (L1, L2) keys for single-keystroke access to a field on the currently displayed screen, or to display a field from another screen.
- See Also**
Global Keys Local Keys
- 3. AVG** This key allows you to display the average value of a number of measurements when the instrument is continuously making measurements.
- To Use Measurement Averaging**
- 1 Position the cursor in front of the measurement's unit-of-measure.
 - 2 Press **SHIFT**, **INCRX10**, (AVG). The default number of average samples is displayed below the measurement.
 - Enter the desired number of measurement samples to be used for calculating the average, or
 - Press **ON/OFF** to use the currently displayed number of samples.
 - 3 To turn averaging off, position the cursor in front of the unit of measure, and press **SHIFT**, **INCRX10**, (AVG) then **ON/OFF**.
- 4. CANCEL** This key cancels the current operation.
- 5. CELL CNTL** This key accesses the Cell Control screen. This is the screen that appears at power-up or after preset.
- See Also**
Screens: Cell Control

Keys

Function Keys

6. CELL CONFIG This key accesses the Cell Config screen, giving access to Base Station emulation parameters.

See Also

Screens: Cell Config

7. END CALL This key ends a call-in-progress.

8. HI LIMIT This key is used if you want to be alerted when a measurement exceeds a specified value.

To Set a High Limit

- Position the cursor at the measurement field of your choice.
- Press **SHIFT**, **↑** (HI LIMIT).
- Enter the value you want the high limit to be.
- Press **ENTER** or a units key. A HI (or H) annunciator will appear.

If a limit is exceeded during a measurement, a beep will sound (the beeper ON/OFF control can be found in the Configure screen) and “Measurement high limit exceeded” will be displayed. The HI (or H) annunciator will also flash as long as the measurement is displayed.

To Turn Off (or On) a High limit

When a limit is turned off, its value is retained but is not used.

- Press **SHIFT**, **↑** (HI LIMIT).
- Press **ON/OFF**

9. HOLD This key is used to retain measurement results by stopping swept or continuously updated measurements.

10. INCR ÷10 This key is used to adjust the increment value by a factor of ÷10. To display the increment value, press **INCR SET**.

11. INCR ×10 This key is used to adjust the increment value by a factor of ×10. To display the increment value, press **INCR SET**.

12. INCR SET

This key is used to display or set the increment value.

- 1 Press **INCR SET**.
- 2 Enter an increment value using the DATA keys.

13. LO LIMIT

This key is used if you want to be alerted when a measurement is less than a specified value.

To Set a Low Limit

- Position the cursor at the measurement field of your choice.
- Press **SHIFT**
- Press **↓** (LO LIMIT).
- Enter the value you want the lower limit to be.
- Press **ENTER** or a units key. A LO (or L) annunciator will appear.

If a limit is exceeded during a measurement, a beep will sound (the beeper ON/OFF control can be found in the Configure screen) and “Measurement low limit exceeded” will be displayed. The LO annunciator will also flash as long as the measurement is displayed.

To Turn Off (or On) a Low limit:

When a limit is turned off, its value is retained but is not used.

- Press **SHIFT**
- Press **↓** (LO LIMIT).
- Press **ON/OFF**

14. MEAS ARM

This key is used to arm a one-time-only (Meas Trig, Single) measurement. After MEAS ARM is pressed, the instrument will wait for a valid trigger event, then make the measurement currently selected. Meas Arm only applies to Phase/Freq, Pwr Ramp, BER, Output RF Spectrum, and Pulse On/Off measurements. It can be particularly useful for measuring RACH bursts.

See Also

Screens: Measurement Sync (**Meas Trig**)

Keys

Function Keys

- 15. MEAS SYNC** This key is used to access the measurement synchronization screen.
- See Also**
Screens: Measurement Sync
- 16. METER** This key is used to display a measurement in both a digital readout and an analog meter display. You can choose your own meter scale by selecting the Meter choices in the bottom right-hand corner of the screen.
- 1 Position the cursor in front of the unit-of-measure for the measurement you want to display.
 - 2 Press **SHIFT**, **INCR SET**, (METER). To display the Meter menu in the lower-right corner of the screen.
 - 3 Select On/Off to display the meter.
- 17. MS INFO** This key is used to access the MS (mobile station) Information/Signaling screen.
- 18. MSSG** This key is used to access the message screen.
- See Also**
Screens: Message
- 19. NO** This key is used to respond to Yes/No questions that appear on the screen.
- 20. ON/OFF** This key is used to turn functions on or off.
- 21. ORG CALL** This key, Originate Call, is used to make a base-station-originated call from the **ORG CALL**.
- 22. PREV** This key is used to return to the screen displayed prior to the current screen.
- 23. PRINT** This key is used to print the current screen.
- See Also**
Screens: Configure

24. RCV CALL

This key configures the **ORG CALL** so that it will receive a mobile phone originated call. It is not necessary to press this key when you are in the Cell Control screen.

See Also

Screens: Cell Control, Configure

25. RECALL

This key is used to recall instrument setups.

To Recall an Instrument Setup

- 1 Press **RECALL**.
- 2 Use the knob to select the desired setup to be recalled from the choices at the bottom right of the screen.

When Recall is pressed, the following fields are ALWAYS set to their default settings regardless of their setting in the saved setup.

- Demod Arm, Arm/Disarm is always reset to Disarm (Cell Control 2 screen).
- Settable or Activated is always reset to Activated (Cell Configuration) or Active Cell (Cell Control screen).
- Hop Mode, Non-Hop/Hop is always reset to Hop (RF Generator/RF Analyzer screen).
- Hop Control, Arm/Disarm is always reset to Arm (RF Generator/RF Analyzer screen).

If the recalled state includes being on a call, the **ORG CALL** will assume that mobile phone is connected. It will attempt to establish a call. This may require you to answer the call on the mobile phone.

Keys

Function Keys

26. REF SET

This key is used to set a reference if you want a measurement result to be offset by a certain value.

To Set a Reference

1 Use the knob to position the cursor at the measurement field of your choice.

2 Press **SHIFT**, **INCR+10** (REF SET)

The current reference value, with the word Reference below it, is displayed.

If you want the current measurement result to be the reference, press **ENTER** and skip the next two steps.

3 Enter the value you want the Reference to be.

4 Press a units key to set the Reference. Or, press **ENTER** or the knob to default to the units currently displayed.

When a measurement is displayed, REF (or R) will be displayed below it.

To Turn a Reference Off or On

When a reference is turned off, its value is stored but not applied to the measurement.

A Reference can be turned off, or turned back on using the ON/OFF key.

- Press **SHIFT**, **INCR+10**, (REF SET)
- Press **ON/OFF**.

The REF (or R) annunciator will be dimly displayed when the Reference is on.

When you turn the Reference off, the absolute measurement value will be displayed with no annunciator.

27. RELEASE

This key is used to clear a global (G1, G2, G3) or local (L1, L2) key.

See Also

Global Keys Local Keys

28. RFG/RFA This key is used to access the RF Generator/RF Analyzer screen, and gain direct control over the internal source and receiver.

NOTE

The changes to settings on this screen may affect the operation of the Cell Control screen. Pressing **PRESET** will ensure that the instrument returns to a known state.

See Also

Screens: RF Generator / RF Analyzer

29. SAVE

This key is used to save instrument setups to be recalled later.

Changes made on the Configure and Tests screens are automatically maintained through power-down and Preset cycles.

Help, Message, and Tests screens cannot be saved. The states of the following fields will not be saved: Demod Arm, Hop Arm, Activated, Meas Arm.

To Save an Instrument Setup

- 1 Make any changes to the instrument that you want to SAVE.
- 2 Press **SHIFT** , **RECALL** to save.
- 3 Name the setup using the data keys, or the Save choices at the bottom right of the screen. (You can use numbers, letters, or a combination of both.)

30. TESTS

This key is used to access the Tests screen. This is where the IBASIC Test Software Applications can be run from. Refer to chapter 8, *Instrument BASIC* for more information.

31. USE MEM

This key arms and triggers a DSP measurement using data captured in memory. USE MEM is not available when continuous measurements are selected. Select single in the MEAS SYNC screen to allow this operation.

See Also

Screens: Measurement Sync [**Trig Source (Use Mem)**, **Status (Use Mem)**] Screens: Measurement Sync (**Status**), [Single/Cont (Meas Trig)] Screens: Cell Configuration

32. YES

This key is used to respond to Yes/No questions that appear on the screen.

Local Keys

L1, L2

Keys L1 and L2 are local keys. They are used to move between fields on the screen that is currently displayed.

To Assign a Local Key

- Use the knob to position the cursor at the field of your choice.
- Press **SHIFT**
- Press **L1** (ASSIGN).
- Press one of the Local keys **L1**, **L2**.

The field you assigned should now have the local number next to it.

When you press the local key, the chosen field will be accessed. A toggled field will toggle or cause immediate action in certain types of fields.

Re-assigning the local key clears the previous setting, or pressing **RELEASE** and then a local key clears that key.

NOTE

Some fields cannot be assigned to local keys.

To Use Pre-Assigned Local Keys

Fields that might be used frequently have local keys assigned to them by the factory. Following this procedure will make the factory assigned local keys available.

- 1 Press **SHIFT**, **ASSIGN**, **ENTER**. The numbers 1 and 2 will appear in front of the two pre-assigned fields.
- 2 Press the Local key (L1 or L2) and notice how the cursor immediately moves to the corresponding field.
- 3 To stop using the default Local keys, press **SHIFT**, **RELEASE**, **ENTER**.

Global Keys

G1, G2, G3

Keys G1 through G3 (**SHIFT** **ORG CALL** - (G1), **RCV CALL** - (G2), or **END CALL** - (G3) are global keys. They can access fields that are not displayed on the current screen.

To Assign a Global Key,

- Use the knob to position the cursor at the field of your choice.

NOTE

The following screens do not allow global keys to be assigned, or allow fields to be pulled in from other screens: TEST, HELP, and MESSAGE.

- Press **SHIFT**
- Press **L1** (ASSIGN).
- Press **SHIFT**
- Press one of the global keys, G1, G2, or G3.

The field you assigned can now be accessed from any allowable screen. You can also make changes to the assigned field.

NOTE

Some fields cannot be assigned to global keys.

Units Keys

Units in some field types can be changed by pressing an applicable units key.

- Pressing a units key while the cursor is positioned next to a measurement field converts the measurement to the new units, for example, dBm, W, V.
- Pressing a units key before a measurement is displayed changes the units displayed and will display any new measurement in the new units.
- Pressing a units key while the measurement display is turned off will turn on the measurement display showing the new units.

Connectors

NOTE:

If you have the **Agilent 8922M/S Option 010 Multi-Band Test System**, refer to the appropriate *Agilent 8922 Multi-Band User's Guide* for more information on connection and operating differences.

Front-Panel Connectors of the Agilent Technologies 8922M/S

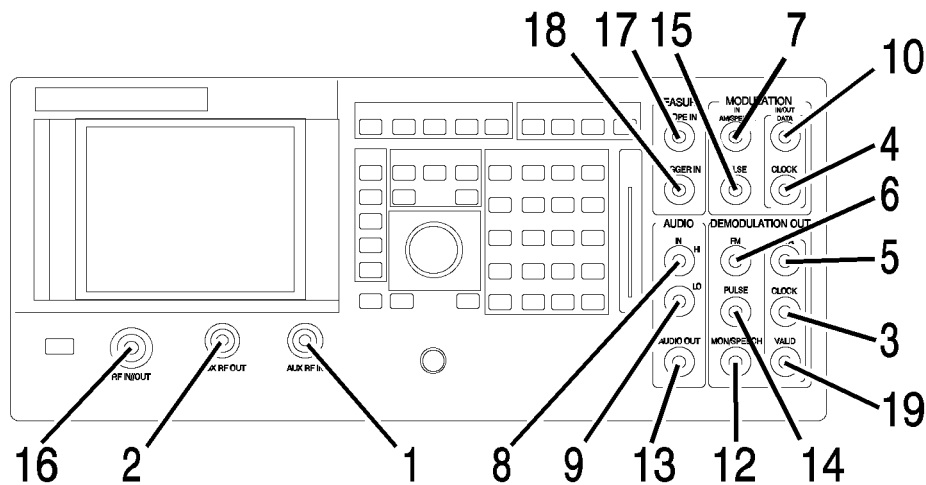

1. AUX RF IN

The auxiliary RF input connects to the input section and to the RF analyzer (if selected). This connector provides a higher sensitivity and lower maximum-power connection from the DUT. It is not normally used for transceiver testing but is a useful input to the Spectrum Analyzer (option 006).

AUX RF IN has its own input level setting (RF analyzer amplitude) separate from RF IN/OUT. It is reverse power protected.

This connector is selected when the RF analyzer's RF input is set to AUX RF IN.

See Also Screens: RF Generator/RF Analyzer, (RF Analyzer)

2. AUX RF OUT

The auxiliary RF output connects to the output section from the RF generator's step attenuators (if selected). This connector provides higher output levels to a device-under-test (DUT). It is not normally used for transceiver testing.

This connector has its own output amplitude setting (RF generator amplitude) separate from RF IN/OUT. It is reverse power protected.

This connector is selected when the RF generator's RF output is set to AUX RF OUT.

See Also Screens: RF Generator/RF Analyzer, (RF Gen)

**3. CLOCK
(DEMODULATION
OUT)
(Agilent 8922M
Only)**

The clock connector is connected to the power ramp's digital demodulation clock output. This signal is the digital demodulation CLOCK signal which is generated when digitally demodulating one out of eight timeslots of GSM 0.3 GMSK modulation.

CLOCK (DEMODULATION OUT) is only active when the digital demodulation mode is selected and armed. This is a fast burst of clocks, not a continuous clock.

This connector is undefined when the demodulation output data valid signal is TTL high

This connector is connected directly in parallel with DEMOD_CLK on the SYSTEM BUS connector.

Requirements High drive: 1 mA Low drive: 1 mA Duty cycle: 50% Repetition Rate: 1 MHz

See Also Screens: Pwr Ramp Specifications Signal Descriptions for the System Bus Timing Diagrams

**4. CLOCK
(MODULATION)
(Agilent 8922M
Only)**

CLOCK (Input)

The clock connector is connected to the Premod/NSM circuitry. This connector is used in combination with DATA (MODULATION IN).

CLOCK (MODULATION IN) is selected when the RF generator's modulation source GMSK field is set to Ext. This connector is directly in parallel with FP_CLOCK on the SYSTEM BUS connector.

This must be a continuous signal. Also, significant phase changes or loss of this signal will result in an out-of-lock condition in the data synchronizer.

NOTE

The two inputs are directly coupled to each other. Avoid putting signals on both inputs simultaneously.

Clock Input Requirements

High drive requirement: 100 μ A Low drive requirement: 1.2 mA Active edge: rising edge

Connectors

Front-Panel Connectors of the Agilent Technologies 8922M/S

5. DATA (DEMODULATION OUT) (Agilent 8922M Only)

This connector is the digital demodulation DATA signal which is generated when digitally demodulating one out of eight timeslots of GSM 0.3 GMSK modulation.

DATA (DEMODULATION OUT) is only active when the demodulation is armed. This is a fast burst of data, not continuous data.

This output is undefined when the demodulation output data valid signal is TTL HIGH. Differential data decoding is done internally.

DATA (DEMODULATION OUT) is active only when the digital demodulator's State field is set to Arm.

This connector is connected directly in parallel with DEMOD_DATA on the SYSTEM BUS connector.

Requirements High drive: 1 mA Low drive: 1 mA

See Also Screens: Cell Control 2 Specifications Signal Descriptions for the System Bus Timing Diagrams

6. FM (DEMODULATION OUT) (Agilent 8922M Only)

The FM connector is connected to the receiver circuitry. This connector provides an output of the FM discriminated signal.

This signal is muted whenever the pulsed RF input signal is OFF.

This output is always active.

See Also Specifications

7. IN AM/SPEECH (MODULATION) (Agilent 8922M Only)

This connector can be used for transmitting speech to a mobile phone. To select speech, choose Cond or Uncond from the Cell Control 2 screen, Speech field.

This connector is also used as the DC AM input of the Agilent 8922M/S. To select DC AM, choose Ext from the RF Generator/RF Analyzer screen, DC AM field. The RF carrier will now be AM modulated (with fixed sensitivity) through this connector.

See Also Screens: Cell Control 2 (**Speech**) Screens: RF Generator/RF Analyzer, (RF Gen) (**DC AM**) Screens: Audio, (**AF An1 In**) Specifications

NOTE

IN AM/SPEECH and AM IN (a rear-panel connector) are connected directly in parallel. Avoid putting signals on both inputs simultaneously.

8. IN HI (AUDIO) The input high connector is connected to the audio analyzer input. This connector is used as the main (external) audio analyzer input connection (when selected). This connector is also used in combination with the audio input low signal to input a floating input signal (for better noise performance) to the audio analyzer.

See Also Screens: Audio (**Audio In Lo**)

9. IN LO (AUDIO) The input low connector is connected to the audio analyzer input. This connector is the main (external) audio analyzer input connection (when selected, and in FLOAT mode).

This connector is used in combination with the audio input, high signal to input a floating input signal (for better noise performance) to the audio analyzer.

See Also Screens: Audio (**Audio In Lo**)

Connectors

Front-Panel Connectors of the Agilent Technologies 8922M/S

10. IN/OUT DATA (MODULATION) (Agilent 8922M Only)

Data Input

This connector is a data input when the instrument is settable. (See the Cell Configuration screen.) It is used to input 0.3 GMSK modulation data (if selected) to the RF generator.

This connector is selected when RF generator's modulation source GMSK field is set to Ext. This connector is connected directly in parallel with FP_DATA on the SYSTEM BUS connector.

NOTE

The two inputs are directly coupled to each other. Avoid putting signals on both inputs simultaneously.

Data Input Requirements:

High drive requirement: 100 μ A Setup Time: 150 ns Hold Time: 0 Low drive requirement: 1.2 mA An internal differential data encoder is used. Sense: TTL HIGH results in a positive frequency deviation.

Data Output

IN/OUT DATA becomes a data output when Active Cell is selected and Aux BCCH is set to Adjacent. To simulate an adjacent cell BCCH, IN/OUT DATA and Modulation Clock can be connected to an external 0.3 GMSK signal generator. The channel characteristics of the auxiliary BCCH will be the same as the serving cell BCCH, except that the base station Colour Code (BCC) for the auxiliary BCCH is modulo 4.

Data Output Requirements:

Drive: 4 mA TTL Valid: rising edge of modulation clock Termination: 50 ohms at destination Bit Rate: 13M/48 bps

See Also

Screens: Cell Configuration (**Activated, Aux BCH and Serving Cell, Colour**) Screens: RF Generator/RF Analyzer (RF Gen) Specifications Signal Descriptions for the System Bus

11. MONITOR (DEMODULATION OUT) (Agilent 8922M Only)

The monitor output is connected to the output of the audio analyzer. The same signal choices made for Audio measurements apply to this output. The same signal that goes to the Audio appears at this connector.

This connector is directly in parallel with the rear-panel MONITOR OUT connector.

The output is always active.

See Also

Screens: Audio

- 12. MON/SPEECH (Agilent 8922M Only)** This connector is the output of the audio analyzer. One of several uses for this connector is to monitor the received speech from an MS. To choose demodulated speech, select **SpeechOut** from the Audio screen, **AF An1 In** field. The same signal choices made for Audio measurements apply to this output. The same signal that goes to the Audio appears at this connector.
- MON/SPEECH is directly in parallel with the rear-panel MONITOR OUT connector.
- This output is always active.
- See Also** Screens: Audio, (**AF An1 In**)
- 13. AUDIO OUT** The out connector is connected to a general purpose audio signal(s) output. No internal connection is provided for this signal.
- See Also** Screens: Audio (**AF Gen**)
- 14. PULSE (DEMODULATION OUT) (Agilent 8922M Only)** The pulse connector is connected to the receiver circuitry. This signal provides the demodulated envelope of the RF input signal.
- This output is always active.
- See Also** Specifications

Connectors

Front-Panel Connectors of the Agilent Technologies 8922M/S

15. PULSE (MODULATION) (Agilent 8922M Only)

The PULSE connector connects to the hop controller and to the RF output section (when selected as active).

This signal is the TTL input to externally control when the amplitude is pulsed ON (TTL HIGH) or OFF (TTL LOW). It also pulses the envelope up (TTL HIGH) and down (TTL LOW) when in 30 dB Pulse mode.

This connector can be used in combination with AM (MODULATION IN) to generate pulsed and/or shaped amplitude envelopes of different levels for each RF generator pulse in real-time.

PULSE (MODULATION IN) is selected when the RF generator's modulation source Pulse field is set to Ext. This connector is connected directly in parallel with PULSE_MOD_IN on the SYSTEM BUS connector.

NOTE

The two inputs are directly coupled to each other. Avoid putting signals on both inputs simultaneously.

Requirements High drive requirements: 100 μ A Low drive requirements: 1 mA
TTL HIGH: On or Higher Level TTL LOW: Off or Lower Level

See Also Screens: RF Generator/RF Analyzer (Mod Source)
Specifications Signal Descriptions for the System Bus

16. RF IN/OUT

The RF input/output is connected to the input section to the RF analyzer and the RF generator's step attenuators. It is the main device-under-test (DUT) connection for the radio's RF signals. It is normally used for transceiver testing. This connector is not reverse power protected, but can handle high power levels for extended periods of time because there is a temperature sensor for this signal.

WARNING:

If you have the Agilent 8922M/S Option 010 Multi-Band Test System, do not connect the mobile to this port.

This connector is selected when the RF generator's RF output is set to RF IN/OUT or when the RF analyzer's RF input is set to RF IN/OUT.

17. SCOPE IN (MEASURE)

The measurement input for the oscilloscope connects to the Audio analyzer and to the oscilloscope (when selected as an Audio analyzer input source). This is the input for general purpose oscilloscope measurements, but it can be used for other measurements as well (for example, audio analyzer measurements, filtering an audio signal when used with the demodulation output monitor signal).

See Also Screens: Oscilloscope

**18. TRIGGER IN
(MEASURE)**

The measurement trigger input is the trigger source for the oscilloscope, spectrum analyzer (option 006), Pwr Ramp, Phase/Freq and Data demodulation.

All triggered measurements, when trigger is selected as external, are triggered by this signal.

It is not possible to separately trigger an oscilloscope or spectrum analyzer measurement from a Pwr Ramp measurement.

TRIGGER IN is selected when the digital demodulator's Trig Source is set to Ext Meas, or when the measurement synchronization Trig Source is set to Ext Meas.

See Also Screens: Phase Freq, Pwr Ramp, Oscilloscope, Spectrum Analyzer

**19. VALID
(DEMODULATION
OUT)
(Agilent 8922M
Only)**

This connector is connected to the DSP analyzer's digital demodulation data valid output.

This signal is the digital demodulation data valid signal which is generated when digitally demodulating one out of eight timeslots of GSM 0.3 GMSK modulation. It can be used to load the digitally demodulated data. This signal is used for gate timing when the demodulation output data-signal and the demodulation output clock-signal are valid.

This output is only active while outputting, not while demodulating, and it is only active when the digital demodulation mode is selected and armed.

This connector is connected directly in parallel with DEMOD_VALID on the SYSTEM BUS connector.

Specifications High drive: 1 mA Low drive: 1 mA Active level: LOW Active for: leading tailbits, first half of data, midamble, second half of data, and trailing tailbits. Inactive for: guard bits Duration depends on type of burst being demodulated.

See Also Screens: Cell Control 2 Specifications Signal Descriptions for the System Bus

Rear-Panel Connectors of the Agilent Technologies 8922M/S

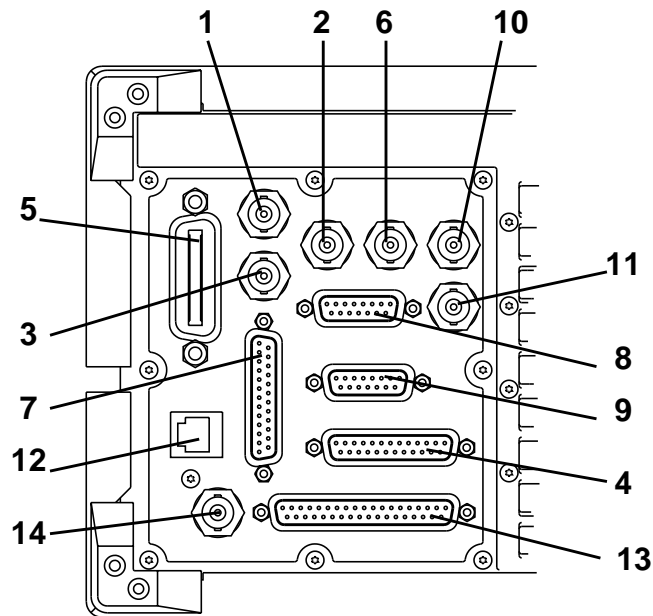

1. 10 MHz OUT

The 10 MHz output connector is connected to the 10 MHz oscillator in the reference circuitry. This signal is a general-purpose 10 MHz reference output (sine wave). This connector can be either free-running or locked to an external reference of 1, 2, 5, 10 or 13 MHz reference. Typically, it is locked to the high-stability timebase reference, (option 001) if it is installed, connected, and enabled.

10 MHz OUT is always active.

See Also Specifications REF IN

2. 13 MHz OUT

The 13 MHz output connector is connected to the 13 MHz oscillator in the reference circuitry. This signal is a general-purpose 13 MHz reference output, (sine wave). It can either be free-running or locked to any external reference of 1, 2, 5, 10 or 13 MHz reference. Typically, it is locked to the high-stability timebase reference, (option 001) if it is installed, connected, and enabled.

13 MHz OUT is always active.

See Also Specifications REF IN

3. AM

This connector is used in conjunction with the HP/Agilent 83220A and HP/Agilent 83220E DCS/PCS Test Sets. Refer to either the *HP/Agilent 83220A* or *HP/Agilent 83220E User's Guides* for further information.

**4. EMMI BUS
(Agilent 8922M
Only)**

The EMMI bus is the Digital Audio Interface defined by GSM Rec. 11.10 sec III.1.4. The EMMI Bus is used to emulate the GSM-standard man-to-machine interface and for DAI control.

The pin assignment of the connector is as follows:

| Pin | Usage | Function | To/From |
|---------|----------|----------------|---------|
| 1 | | Chassis ground | |
| 2 | EMMI TX | Signal | To ME |
| 3 | EMMI RX | Signal | From ME |
| 4 - 6 | Not used | | |
| 7 | EMMI | Signal ground | |
| 8 - 10 | Not Used | | |
| 11 | DAI | Test control 1 | To ME |
| 12 | DAI | Signal ground | To ME |
| 13 | DAI | Test control 2 | To ME |
| 14 - 21 | Not Used | | |
| 22 | DAI | Reset | To ME |
| 23 | DAI | Data | From ME |
| 24 | DAI | Data Clock | From ME |
| 25 | DAI | Data | To ME |

ME (Mobile Equipment)

DAI input 24, Data Clock, is terminated in 10 k Ω .

Connectors

Rear-Panel Connectors of the Agilent Technologies 8922M/S

Electrical Characteristics of the DAI/EMMI

The state of a signal pin is defined by the voltage (V) between the pin and its associated ground.

| Logical State | Voltage (V) | Current |
|------------------|---------------------------------------|--------------------|
| 0 or LOW or ON | $0\text{ V} < V < +0.8\text{ V}$ | 2.4 mA |
| 1 or HIGH or OFF | $+3.5\text{ V} < V < +5\text{ V}$ | -400 μA |
| Undefined | $+0.8\text{ V} < V < 3.5\text{ V}$ | |
| Forbidden | $V < 0\text{ V}$ or $V > +5\text{ V}$ | |

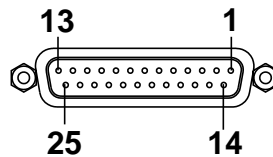

Figure 6-1 EMMI Connector Pin Numbers

See Also

Screens: Cell Control (DAI: **Test**, **Norm**)

5. GPIB

The General Purpose Interface Bus is an IEEE-488.1 connector. It is connected to the main microprocessor. This connector is used for IEEE-488.1 operation and control of other instruments using IBASIC (if available).

The instrument can be talker and listener, or a controller, depending on selection made in the Mode field on the Configure screen.

GPIB is always active.

See Also

Screens: Configure Specifications, GPIB, GPIB Connections

Rear-Panel Connectors of the Agilent Technologies 8922M/S

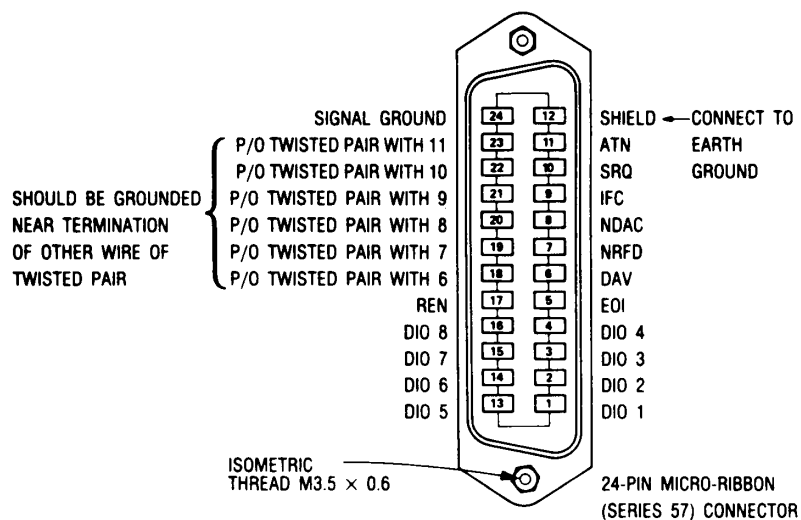
**Logic Levels**

The General Purpose Interface Bus logic levels are TTL compatible, that is, the true (1) state is 0.0 Vdc to +0.4 Vdc and the false (0) state is 2.5 Vdc to +5 Vdc.

Programming and Output Data Format

Refer to Section 3 "Operation".

Mating Connector

Agilent
1251-0293; Amphenol 57-30240

Mating Cables Available

Agilent10833A, 1 meter (3.3 ft.), 10833B 2 meters (6.6 ft.)
Agilent10833C 4 meters (13.2 ft.), 10833D, 0.5 meters (1.6 ft.)

Cabling Restrictions

1. A General Purpose Interface Bus system may contain no more than 2 meters (6.6 ft.) of connecting cable per instrument.
2. The maximum accumulative length of connecting cable for any General Purpose Interface Bus system is 20 meters (65.6 ft.).

Connectors

Rear-Panel Connectors of the Agilent Technologies 8922M/S

6. OPT 001 REF OUT

The option 001 reference output connector, when present, is connected to an high-stability 10 MHz reference. Typically, it is connected to REF IN (using an Agilent supplied short jumper cable) to get all timebase references locked to the high-stability timebase reference. This connector can also be used as a general-purpose output.

This output should be turned off when not in use, to reduce spurs and other unwanted signals.

Option 001 REF OUT is turned on and off by the OPT 001 REF OUT field on the Configure screen.

See Also

Screens: Configure Specifications REF IN

7. Parallel Port

This port is used with printers requiring a parallel interface when printing. Use address 15 when sending data to this port from IBASIC Programs

Pin assignments are as follows;

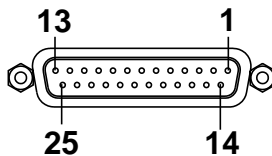

- 1 nStrobe
- 2 Data 1 (Least Significant Bit)
- 3 Data 2
- 4 Data 3
- 5 Data 4
- 6 Data 5
- 7 Data 6
- 8 Data 7
- 9 Data 1 (Most Significant Bit)
- 10 nAck
- 11 Busy
- 12 PError
- 13 Select
- 14 nAutoFd
- 15 nFault
- 16 nInit
- 17 nSelectIn
- 18 Signal Ground (nStrobe)
- 19 Signal Ground (Data 1 and Data 2)
- 20 Signal Ground (Data 3 and Data 4)
- 21 Signal Ground (Data 5 and Data 6)
- 22 Signal Ground (Data 7 and Data 8)
- 23 Signal Ground (Busy and nFault)
- 24 Signal Ground (PError, Select and nAck)
- 25 Signal Ground (nAutoFd, nSelectIn and nInit)

8. PCN Interface

This connector is used in conjunction with the HP/Agilent 83220A and HP/Agilent 83220E DCS/PCS Test Sets. Refer to either the *HP/Agilent 83220A* or *HP/Agilent 83220E User's Guides* for further information.

Connectors

Rear-Panel Connectors of the Agilent Technologies 8922M/S

- 9. Protocol Interface** This port is only available if Option 003 is fitted. It allows protocol messages to be sent to an external protocol logger.
Refer to Appendix A for more information.
- 10. REF IN** The timebase reference input is a BNC connector. It is connected to the reference circuitry. This connector is the main timebase reference input. Normally, it is connected to Option 001 REF OUT (if option 001 is installed) using an Agilent-supplied short jumper cable. RF IN can also be connected to a user-provided 1, 2, 5, 10 or 13 MHz reference by selecting the appropriate frequency from the Reference field on the Configure screen.
If RF IN is left unconnected, the internal timebase will not be locked to any external reference.
See Also
Screens: Configure Specifications
- 11. SCOPE** This connector is used in conjunction with the HP/Agilent 83220A and HP/Agilent 83220E DCS/PCS Test Sets. Refer to either the *HP/Agilent 83220A* or *HP/Agilent 83220E User's Guides* for further information.

12. SERIAL PORT The serial interface port is a multipin connector. It is connected to the main microprocessor. It is used to connect a terminal to develop IBASIC programs, locally, without an external GPIB controller. It can also be used for printing the contents of the display.

SERIAL PORT is always active.

Specifications

Baud Rates:

300
1200
2400
4800
9600
19200

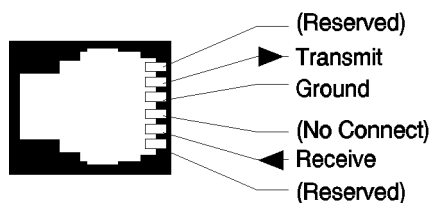

13. SYSTEM BUS The system bus connector is used to externally control frequency hopping and contains duplications of several individual connectors.

See Also

Signal Descriptions for the System Bus

NOTE

This feature is not supported in the Agilent 8922S.

14. VIDEO OUT The video output connector connects to the CRT hardware. It can be used to connect a larger display.

VIDEO OUT is always active. The Video Out format is a 15 kHz PAL compatible signal.

Signal Descriptions for SYSTEM BUS

System Bus Pin Number Overview

Table 2-1

System Bus Connector Pin Numbers

| Pin Number | Signal Name | Pin Number | Signal Name |
|------------|----------------|------------|----------------|
| 1 | FP_DATA | 20 | FP_CLOCK |
| 2 | GND | 21 | MEAS_TRIG_OUT |
| 3 | RP_GSM_RST_IN | 22 | DEMODO_DATA |
| 4 | DEMODO_CLK | 23 | DEMODO_VALID |
| 5 | RP_GSM_RST_OUT | 24 | G_EXT_TRIG_OUT |
| 6 | PULSE_MOD_IN | 25 | GND |
| 7 | RP_DMOD_TRIG | 26 | RP_BURST_T1 |
| 8 | RP_BURST_T2 | 27 | RP_BURST_T3 |
| 9 | SEQ_TRIG_OUT | 28 | RP_TX_HOP |
| 10 | RP_RX_HOP | 29 | RP_SEQ_HOP |
| 11 | RP_RST_SEQ_HOP | 30 | RP_HOP_INHIBIT |
| 12 | RP_HOP_ADRS0 | 31 | RP_HOP_ADRS1 |
| 13 | RP_HOP_ADRS2 | 32 | RP_HOP_ADRS3 |
| 14 | RP_HOP_ADRS4 | 33 | RP_HOP_ADRS5 |
| 15 | RP_HOP_ADRS6 | 34 | RP_HOP_ADRS7 |
| 16 | RP_HOP_ADRS8 | 35 | RP_HOP_ADRS9 |
| 17 | RP_HOP_ADRS20 | 36 | GND |
| 18 | RP_RXD | 37 | RP_TXD |
| 19 | GND | | |

**DEMOD_DATA,
DEMOD_CLK,
DEMOD_VALID**

DATA-Pin 22 CLK-Pin 4 VALID-Pin 23 Outputs

These are the digital demodulation data output signal, the digital demodulation clock output signal, and the digital demodulation valid output signal. These signals are connected directly in parallel with their respective front-panel connectors.

See Also Front Panel Connectors: DATA (DEMODULATION OUT),
CLOCK (DEMODULATION OUT), VALID
(DEMODULATION OUT)

**FP_DATA,
FP_CLOCK**

DATA-Pin 1 CLOCK-Pin 20 Inputs

These are the front-panel DATA, and CLOCK inputs. These signals are connected directly in parallel with their respective front-panel connectors.

NOTE

The two inputs are directly coupled to each other. Avoid putting signals on both inputs simultaneously.

See Also DATA (MODULATION IN) CLOCK (MODULATION IN)

**G_EXT_TRIG_
OUT**

Pin 24 Output

This output is a 1-bit-wide trigger. The timeslot and bit position in the timeslot are programmable on the Service screen.

Requirements Amplitude: TTL Levels Low Drive: 10 μ A High Drive: 2 mA

See Also Screens: Service

MEAS_TRIG_OUT **Pin 21 Output**

This output signals when a DSP measurement is being made. It is used as an auxiliary trigger output signal for use with an external spectrum analyzer.

Connectors

Signal Descriptions for SYSTEM BUS

PULSE_MOD_IN Pin 6 Input

This is the pulse modulation input. This signal is connected directly in parallel with the PULSE (MODULATION IN) front-panel connector.

NOTE

The two inputs are directly coupled to each other. Avoid putting signals on both inputs simultaneously.

See Also Screens: RF Generator Front-Panel Connectors: PULSE (MODULATION IN)

**RP_BURST_T1,
RP_BURST_T2**

T1-Pin 26, T2-Pin 8 Select/Control

These are the rear-panel power ramp burst type select signals. They are connected to the DSP analyzer. These signals can be used during power ramp measurements to select the burst type in real-time for each burst being operated on.

When digitally demodulating, burst select must be set to Ext to use these signals. When making triggered measurements, the measurement synchronization burst selection must be set to Ext. Each of the four burst type definitions can be selected.

Requirements Amplitude: TTL levels High drive requirement: 100 μ A Low drive requirement: 2 mA

Table 2-2 System Bus Connector Pin Numbers

| RP_BURST_T2 | RP_BURST_T1 | BURST NUMBER SELECTED |
|-------------|-------------|-----------------------|
| TTL LOW | TTL LOW | 0 |
| TTL LOW | TTL HIGH | 1 |
| TTL HIGH | TTL LOW | 2 |
| TTL HIGH | TTL HIGH | 3 |

See Also Screens: Measurement Sync Specifications Timing Diagrams

RP_DMOD_TRIG Pin 7 Input

This is the rear-panel trigger signal input for digital demodulation. It connects to the DSP analyzer. It can also be used for other triggered measurements.

This signal is active when the digital demodulator's demodulation trigger source is set to Ext Demod, or when the measurement synchronization trigger source is set to Ext Demod.

Requirements Amplitude: TTL levels High drive requirements: 100 μ A Low drive requirements: 2 mA Active edge: rising edge.

See Also Screens: Power Ramp, Phase Freq(**Data Bits**) Specifications Timing Diagrams

RP_GSM_RST_IN Pin 3 Input

This connector is an active low input that halts and resets the Agilent 8922 GSM counters (frame, timeslot, and bits). It is used when two or more Agilent 8922M/S are connected together (daisy-chained) to simulate a GSM system.

Requirements Amplitude: TTL Levels Low Drive: 100 μ A High Drive: 2 mA Active Level: Low

RP_GSM_RST_OUT Pin 5 Output

This connector indicates whether the Agilent 8922M/S GSM counters have been halted (by RP-GSM-RST-IN). It is always active (TTL Low) when the Agilent 8922M/S is in the Settable Mode.

Requirements Amplitude: TTL Levels Low Drive: 100 μ A High Drive: 2 mA Active Level: Low

Connectors

Signal Descriptions for SYSTEM BUS

**RP_HOP_ADRS0,
through
RP_HOP_ADRS9,
RP_HOP_ADRS10**

**ADRS0-Pin 12, ADRS1-Pin 31 ADRS2-Pin 13, ADRS3-Pin 32 ADRS4-Pin 14,
ADRS5-Pin 33 ADRS6-Pin 15, ADRS7-Pin 34 ADRS8-Pin 16, ADRS9-Pin 35
ADRS10-Pin 17, Inputs**

These are the rear-panel hop frequency table address input lines. They connect to the hop controller. These lines select entries from user-entered RF generator and RF analyzer hop frequency tables. These lines have multiple uses, depending on the selected modes.

- 1 Used in combination with RP_TX_HOP to frequency hop the RF generator.
- 2 Used in combination with RP_RX_HOP to frequency hop the RF analyzer.
- 3 Used in combination with RP_RST_SEQ_HOP to reset the internal hop address register.

These signals are read on the positive-going edge of RP_TX_HOP when the RF generator's hop mode is set to Hop, the hop trigger is set to Arm, and the hop address source is set to Ext.

These signals can also be read on the positive-going edge of RP_RX_HOP when the RF analyzer's hop mode is set to Hop, the hop trigger is set to Arm, and the hop address source is set to Ext.

Or, these signals are read on the positive going edge on RP_SEQ_HOP when the address source is set to Seq, the RF analyzer's hop trigger is set to Arm, or RF generator's hop trigger is set to Arm.

Requirements Amplitude: TTL levels High drive requirement: 100 μ A Low drive requirement: 1 mA Format: unassigned binary, high=1.

See Also Screens: RFG/RFA (**Hop Control**) Specifications Timing Diagrams

RP_HOP_INHIBIT Pin 30 Input

This is the rear-panel internal hop inhibit input. It connects to the hop controller. It is used to inhibit internal hopping. The internal hop sequence address register is still sequenced, however. This signal should normally be kept TTL high.

This line is active whenever the hop controller' hop address source is set to Seq.

Requirements Amplitude: TTL levels High drive requirements: 100 μ A Low drive requirements: 2 mA Active level: Low

See Also Screens: RFG/RFA (**Hop Control**) Specifications Timing Diagrams

RP_RST_SEQ_HOP Pin 11 Input

This is the rear-panel input to reset the internal hop sequence address register. It connects to the hop controller. This signal is primarily used to reset the internal hop address register to zero before a hopping sequence reaches the end of the hop frequency table(s). The signal should normally be kept TTL high.

This signal is always active. To reset the internal hop sequence counter, however, the reset will only occur on a subsequent RP_SEQ_HOP signal when the hop controller's hop address source is set to Seq.

Requirements Amplitude: TTL levels High drive requirement: 100 μ A Low drive requirement: 2 mA Active level: Low

See Also Screens: RFG/RFA (**Hop Control**) Specifications Timing Diagrams

Connectors

Signal Descriptions for SYSTEM BUS

RP_RX_HOP

Pin 10 Input

This is the rear-panel trigger signal input for hopping the RF analyzer (if selected). It is used when externally addressing the hop frequencies.

You must supply signals on the rear-panel hop frequency table address input lines to select each RF analyzer hop frequency for each RF analyzer hop trigger. Also, the hop controller's hop address source must be set to Ext.

This line is active when the hop controller's hop address source is set to Ext, the RF analyzer's hop mode is set to Hop, and the RF analyzer's hop trigger is set to Arm.

Requirements Amplitude: TTL levels High drive requirement: 100 μ A Low drive requirement: 2 mA Triggered by: rising edge

See Also Screens: RFG/RFA (**Hop Control**) Specifications Timing Diagrams

RP_SEQ_HOP

Pin 29 Input

This is the rear-panel trigger signal input for hopping the RF generator and/or the RF analyzer (if selected). It is used when internally sequencing through the hop frequencies. It is connected to the hop controller. This signal can also be configured to control RF generator output pulsing (automatic level pulsing when this trigger occurs). It is used along with internal hop sequence reset input to control frequency hopping through user-entered RF generator and RF analyzer hop frequency tables.

Hop frequencies are automatically selected through user-entered RF generator and RF analyzer hop frequency tables. Hop frequency table address input lines are used for resetting the internal sequence address register.

For the hop sequence to be active, the hop controller's hop address source must be set to Seq. To generate frequency hops, the hop controller's hop address source must be set to internal, the RF generator's (or RF analyzer's) hop mode must be set to hop, and the RF generator's (or RF analyzer's) hop trigger must be set to arm.

Requirements Amplitude: TTL levels High drive requirements: 100 μ A Low drive requirements: 2 mA Triggered by: rising edge

See Also Screens: RFG/RFA (**Hop Control**) Specifications Timing Diagrams

Screens: RFG/RFA (**Hop Control**) Specifications Timing Diagrams RP_RST_SEQ_HOP

RP_TXD, RP_RXD TXD-Pin 37 RXD-Pin 18 Output/Input

These are the rear-panel serial transmit data and rear-panel serial receive data lines.

NOTE

Ground signals not listed individually here.

RP_TX_HOP Pin 28 Input

This is the rear-panel trigger signal input for hopping the RF generator (if selected). It is used when externally addressing the hop frequencies. It is connected to the hop controller. It can also be configured to control RF generator output pulsing (automatic level pulsing when this trigger occurs).

You must supply signals on the rear-panel hop frequency table address input lines to select each RF generator hop frequency for each hop trigger. Also, the hop controller's hop address Source field must be set to Ext.

This line is active when the hop controller's Source field is set to Ext, the RF generator's hop mode is set to Hop, and the RF generator's hop trigger is set to Arm.

Requirements Amplitude: TTL levels High drive requirement: 100 μ A Low drive requirement: 2 mA Triggered by: rising edge

See Also Screens: RFG/RFA (**Hop Control**) Specifications Timing Diagrams

SEQ_TRIG_OUT Pin 9 Output

This is the sequence trigger output. It is connected to the DSP analyzer. It outputs a positive-going pulse when an internal sequence goes through something other than the next higher address, or when reset occurs (Hop Address Source=Int).

Connectors

Signal Descriptions for SYSTEM BUS

USE_MEM_EXT_T RIG 27 Pin Input

This is the external trigger source for Use Mem.

When Trig Source is Ext (see Screens: Digital Demod), a TTL high on this pin will initiate data capture for Use Mem.

RP_BURST_T1 and RP_BURST_T2 must select the correct burst number (see signal descriptions for RP_BURST_T1, RP_BURST_T2).

Input

High: demodulated data is stored for later use. Low: data is not stored.

Requirements

TTL High drive: 100 μ A Low: 2 mA

See Also

Keys: Use Mem Connectors: System Bus, RP_BURST_T1, RP_BURST_T2

Timing Diagrams

| Symbol | min | max | description |
|--------|-----------------------|-----------------------|---|
| Tbth | 1.2 ms +Trig Delay | | hold time of valid burst type after demod trigger |
| Tbti | | 500 us +Trig Delay | latency time from demod trigger until valid burst type |
| Tdch | 400 ns | 600 ns | width of high state of DEMOD_CLK (rep rate 1 MHz) |
| Tdcl | 400 ns | 600 ns | width of low state of DEMOD_CLK (rep rate 1 MHz) |
| Tdh | 100 ns | | hold time of DEMOD_DATA after rising edge of DEMOD_CLK |
| Tds | 100 ns | | setup time of DEMOD_DATA prior to rising edge of DEMOD_CLK |
| Tdth | 1 us | | width of high state of demod trigger |
| Tdtl | 1 us | | width of low state of demod trigger |
| Tdtr | 4.615 ms | | time between subsequent demod triggers |
| Tdtv | 3.8 ms +Trig Delay | 4.2 ms +Trig Delay | latency time from demod trigger until DEMOD_VALID active |
| Tva | 200 ns | 400 ns | time from DEMOD_VALID active until rising edge of DEMOD_CLK |
| Tvi | 500 ns | 1 us | time from rising edge of last DEMOD_CLK until NOT DEMOD_VALID |

Figure 6-2

Digital Demodulation Timing Specification Table

Connectors
Timing Diagrams

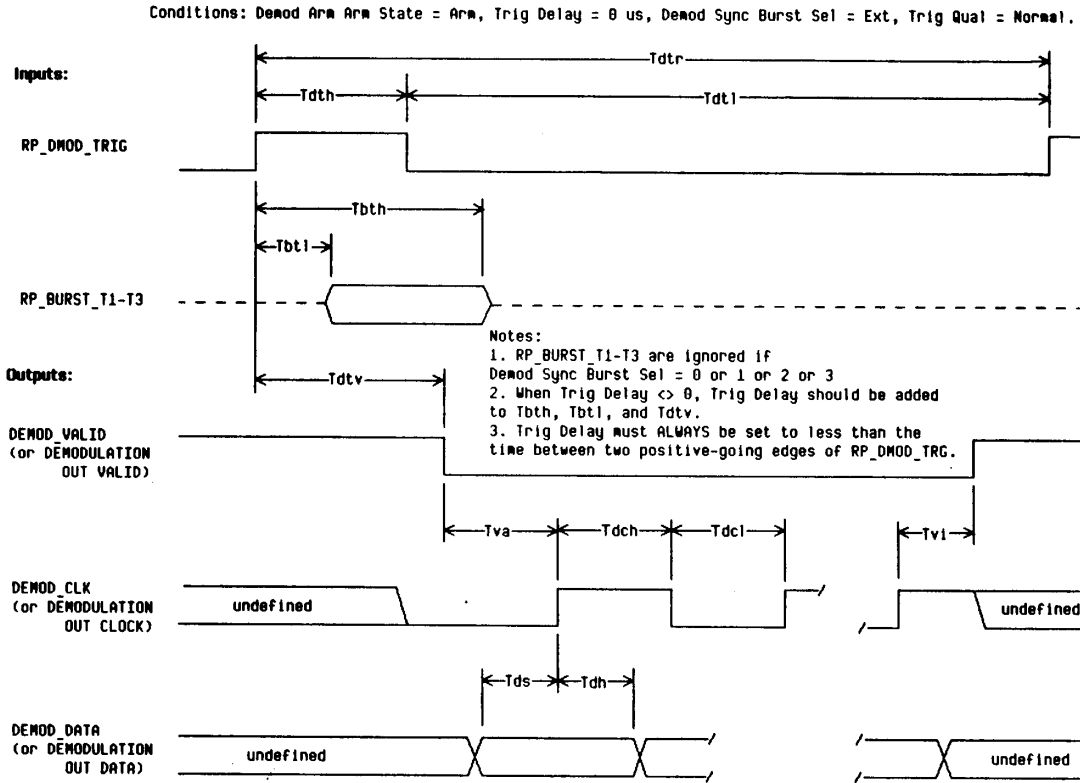

Figure 6-3 Digital Demod Timing Diagram

| Symbol | min | max | description |
|--------|--------|--------|--|
| Ta | 1 us | | time RP_HOP_ADRS0-10 is stable before and/or after event |
| Th | 0 | 570 us | time from hop trigger rising edge for RF Gen or RF Analyzer to meet frequency/phase specs (for 1 timeslot hop) |
| Th2 | 0 | 850 us | time from hop trigger rising edge for RF Gen or RF Analyzer to meet frequency/phase specs (for 1 timeslot hop) during simultaneous hopping |
| Tr | 577 us | | time between subsequent hop triggers of the same type (not useful less than 1.15 ms) |
| Trs | 1 us | | time after RP_RST_SEQ_HOP returns high until RP_SEQ_HOP rising edge can occur |
| Tsr | 1 us | | time after previous RP_SEQ_HOP rising edge until low RP_RST_SEQ_HOP can occur |
| Tw | 1 us | | pulse widths |

Figure 6-4

Frequency Hop Timing Specification Table

Connectors
Timing Diagrams

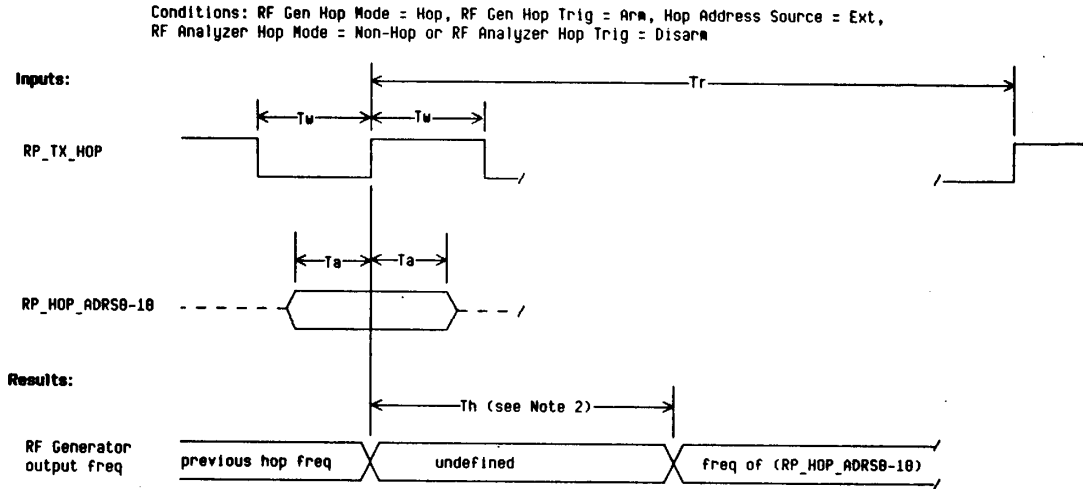

- Notes:**
1. If RF Analyzer Hop Mode = Hop and RF Analyzer Hop Trig = Arm, then this timing diagram applies only if RP_RX_HOP occurs at least 250 us before RP_TX_HOP.
 2. If RF Analyzer Hop Mode = Hop and RF Analyzer Hop Trig = Arm, and RP_RX_HOP occurs between 20 us and 250 us before RP_TX_HOP, then T_h above doesn't apply. Rather, the RF Generator Output will be hopped within T_h2 of the RP_RX_HOP.
 3. When the RF Analyzer should hop before the RF Generator, RP_RX_HOP rising edge should lead the RP_TX_HOP rising edge by at least 10 us.
 4. The RF Generator Output meets phase/frequency accuracy specs for the RF Generator Hop Frequency based on the address on the RP_HOP_ADRS0-10 signals.
 5. The RF Generator Output can also be pulsed off automatically during hopping by selecting RF Generator Mod Source Pulse = Hop Trig.

Figure 6-5 RF Generator Hop (Address Source = Ext) Timing Diagram

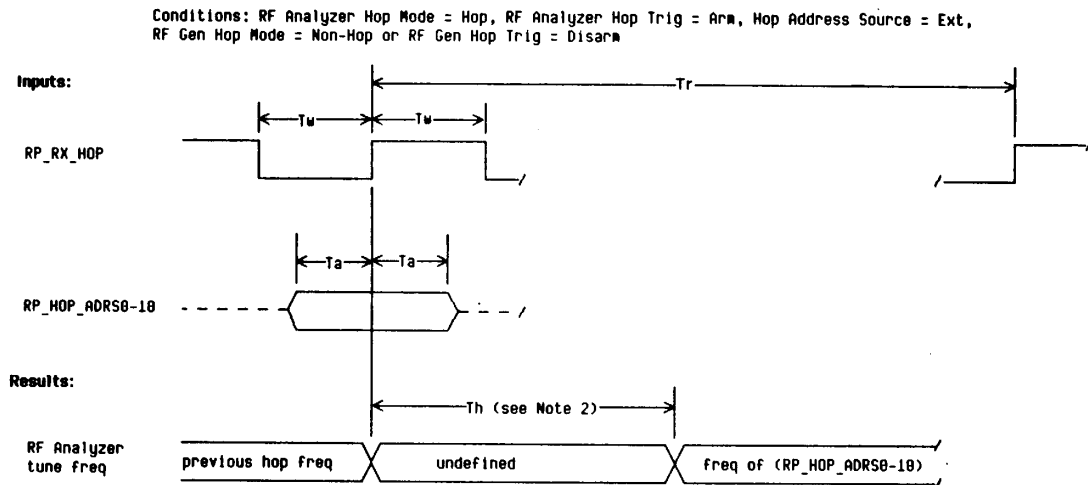

Notes:

1. If RF Gen Hop Mode = Hop and RF Gen Hop Trig = Arm, then this timing diagram applies only if RP_TX_HOP occurs at least 250 us before RP_RX_HOP.
2. If RF Gen Hop Mode = Hop and RF Gen Hop Trig = Arm, and RP_TX_HOP occurs less than 250 us before RP_RX_HOP, then T_h above doesn't apply. Rather, the RF Analyzer tune freq will be hopped within T_{h2} of the RP_TX_HOP.
3. When the RF Analyzer should hop before the RF Generator, RP_RX_HOP rising edge should lead the RP_TX_HOP rising edge by at least 10 us.
4. The RF Analyzer is tuned based on the address on the RP_HOP_ADRS0-10 signals.

Figure 6-6 RF Analyzer Hop (Address Source = Ext) Timing Diagram

Connectors
Timing Diagrams

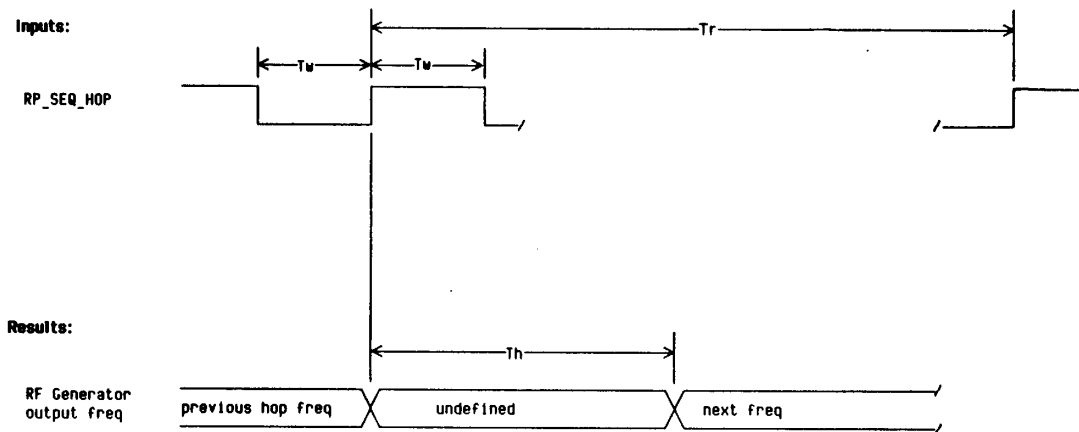

Notes:

1. This Timing Diagram applies even if RF Analyzer Hop Mode = Hop and RF Analyzer Hop Trig = Arr.
2. The RF Generator Output power can also be pulsed off automatically during hopping by selecting RF Generator Mod Source Pulse = Hop Trig.

Figure 6-7 RF Generator Hop (Address Source = Int) Timing Diagram

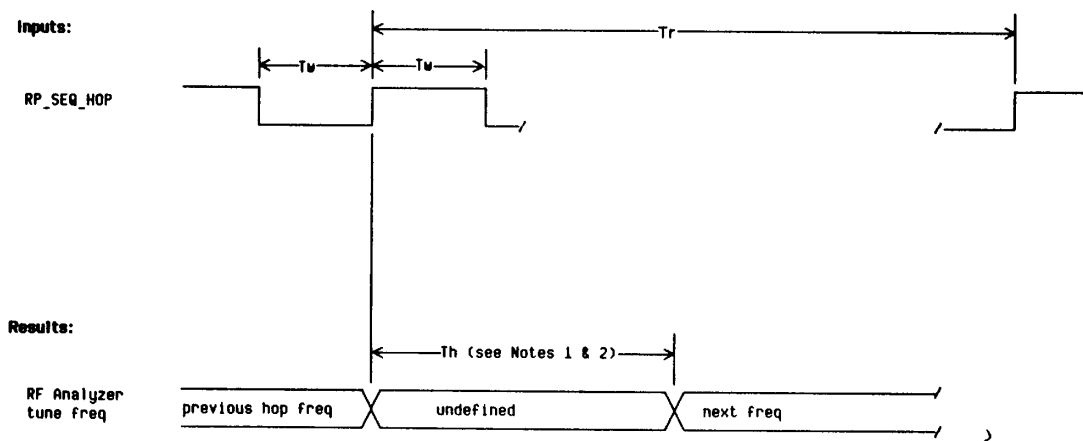

Notes:

1. If RF Gen Hop Mode = Hop and RF Gen Hop Trig = Arm, then T_{h2} applies instead of T_h .
2. If the next freq is the same as the currently tuned frequency, no hopping will occur. This allows the RF Analyzer to settle longer which is needed for making accurate measurements.
3. RP_HOP_INHIBIT is assumed to be high here.

Figure 6-8

RF Analyzer Hop (Address = Int) Timing Diagram

Connectors Timing Diagrams

Conditions: Hop Address Source = Int and { [RF Gen Hop Mode = Hop and RF Gen Hop Trig = ARM] and/or [RF Analyzer Hop Mode = Hop and RF Analyzer Hop Trig = ARM] } .

Inputs:

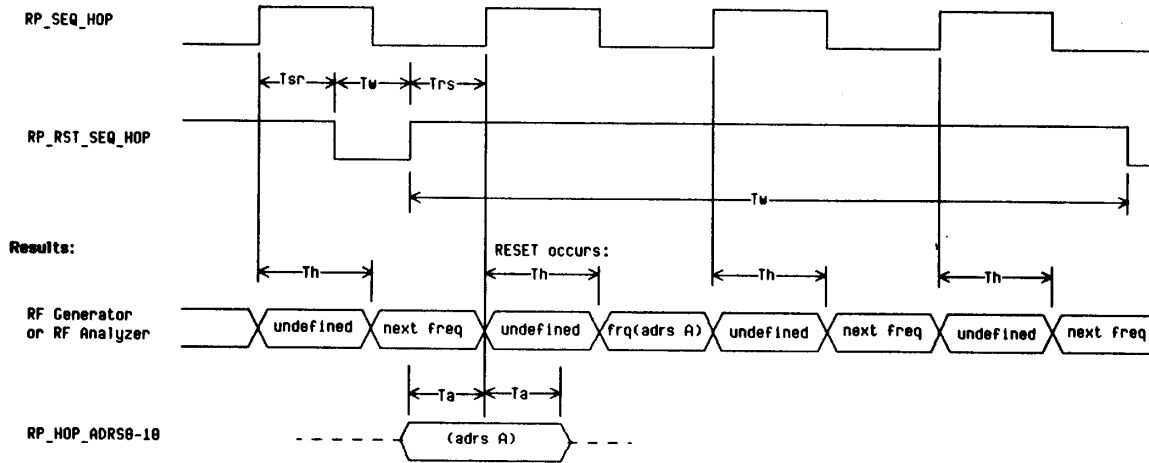

Notes:

1. Tw and Tr for RP_SEQ_HOP as well as Th or Th2 apply as per the other Address Source = Int Timing Diagrams.
2. Note that RP_RST_SEQ_HOP is not required to be TTL LOW at the actual RP_SEQ_HOP rising edge in order to cause RESET. RP_RST_SEQ_HOP is only required to have gone TTL LOW Tsr after the previous RP_SEQ_HOP rising edge and RP_RST_SEQ_HOP must be TTL LOW for at least Tw.
3. RP_HOP_INHIBIT is assumed to be high here.

Figure 6-9 **Reset Hop Once (Address Source = Int) Timing Diagram**

Conditions: Hop Address Source = Int and ([RF Gen Hop Mode = Hop and RF Gen Hop Trig = ARM] and/or [RF Analyzer Hop Mode = Hop and RF Analyzer Hop Trig = ARM]) .

Inputs:

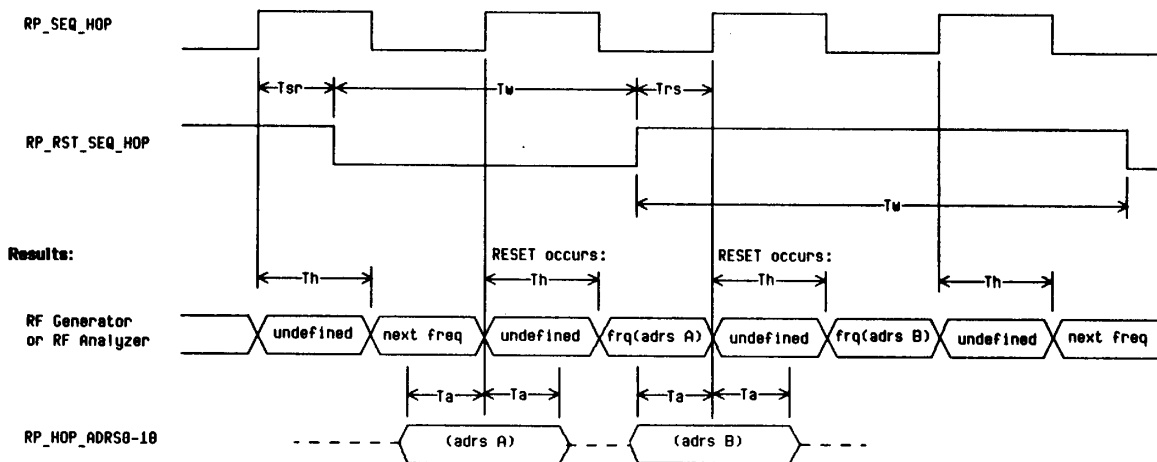

Notes:

1. T_w and T_r for RP_SEQ_HOP as well as T_h or T_{h2} apply as per the other Address Source = Int Timing Diagrams.
2. RP_HOP_INHIBIT is assumed to be high here.

Figure 6-10

Reset and Hold Hop (Address Source = Int) Timing Diagram

Connectors Timing Diagrams

Conditions: RF Gen Hop Mode = Hop, RF Gen Hop Trig = Arm, Hop Address Source = Int, RP_RST_SEQ_HOP stays TTL HIGH.

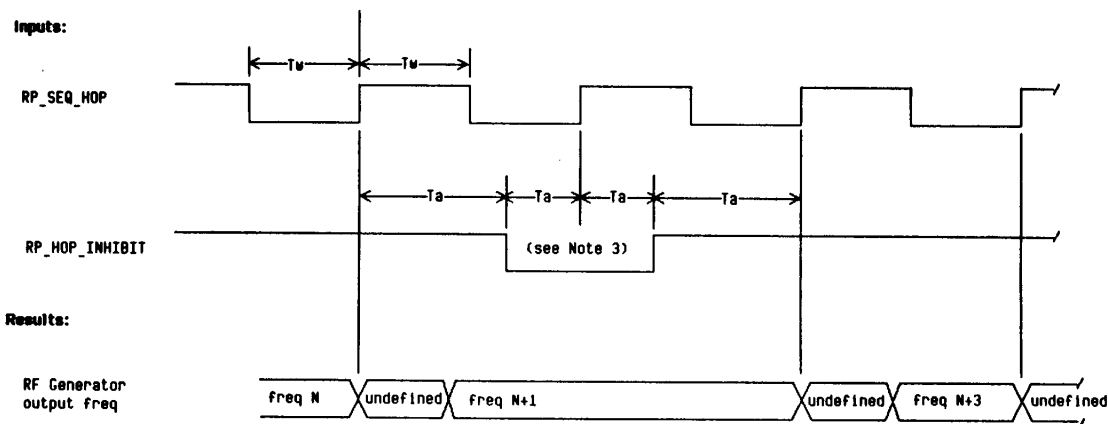

Notes:

1. This Timing Diagram applies even if RF Analyzer Hop Mode = Hop and RF Analyzer Hop Trig = Arm.
2. The RF Generator Output power can also be pulsed off automatically during hopping by selecting RF Generator Mod Source Pulse = Hop Trig.
3. Note that freq N+2 is NOT hopped to, but the hop counter is incremented to N+2.
4. RF Analyzer hopping is affected similarly by the RP_HOP_INHIBIT signal.
5. Assumed here is a sequential hop table.

Figure 6-11

Hop Inhibit (Address Source = Int) Timing Diagram

Messages

Messages can be reviewed by pressing **SHIFT** **MEAS SYNC**, (MSSG). If you have the Agilent 8922M/S Option 010 Multi-Band Test System, there may be additional error messages. Refer to the appropriate *Agilent 8922 Multi-Band User's Guide* for more information.

Communication Failures

The following four messages require you to cycle power on the instrument to continue any operation.

- DSP Analyzer Communication Failure
- Hop Controller Communication Channel Failure
- Protocol Processor Communication Channel Failure
- Communication failure with Signaling Board

Firmware Error

During a power-up cycle the following error message may appear;

Firmware revision error in module XXXXX

Take a note of the module name and contact your local Agilent Technologies Sales and Service Office for more information.

Sync Status

This field displays any errors that occurred while trying to synchronize the demodulated data. Some screens use this field to display progress during multi-burst measurement. When the measurement is completed to field returns to its normal state.

Bad Sync (for demodulation only)

This message appears if a synchronization error happened since the last Demodulation Arm (when Adjust Mode is disabled) or since the last change to Trig Delay (when Adjust Mode is enabled with Demod Arm already selected).

Possible causes of Bad Sync are:

- Useful bits occurred while power was too low.
- Demodulation trigger too early or too late.
- FM (bit) errors found while synchronizing to desired midamble.
- RF overload.

FM Error

At least one bit error was detected when comparing the measured midamble to the selected Midamble or User Defined Sync Pattern, (Sync Mode=Midamble only).

Level Late

The amplitude of the burst did not rise until after the first few bits were received.

Level Short

The amplitude of the burst fell before the last few bits were received.

Low Level

The DSP analyzer's RF level did not rise high enough to make a valid measurement.

No Error

No synchronization error occurred.

RF Ovrload

The measurement hardware overloaded during the measurement. (Increase RF Analyzer Amplitude setting to correct).

ShortBurst

The amplitude envelope was shorter than the expected burst.

Protocol Error Messages

A protocol error may be generated by one of six sources.

- Expiry of a timer
- An error detected by the physical hardware interface layer (PH)
- An error detected by the Data Link layer (DL)
- An error detected by the Radio Resource sublayer (RR)
- An error detected by the Mobility Management sublayer (MM)
- An error detected by the Call Control sublayer (CC)

The error may be fatal or nonfatal. Fatal errors will cause the call to be cleared and will display an error message containing the timer name or the abbreviation for the layer or sublayer (PH, DL, RR, MM, CC), and an error code. Nonfatal errors may only be observed by inspecting the signaling log.

Errors are fatal for calls in progress or signalling being attempted.

Timer names are taken from GSM Rec. 04.06, 04.08 and 05.08, with the exception of T3299, which is Agilent unique.

The timer expiry appears at the top of the display and is of the form:

```
"Call disconnected: timer T??? expired."
```

An unknown timer is reported as:

```
"Call disconnected: cause unknown."
```

Timers

The following is a brief description of the timers.

Physical Layer Timer

T100 Radio Link Failure
 "Loss of SACCH on uplink."

Data Link Layer Timers

T200 Data Link Failure
 "Failed to receive RR or other acknowledgment of
 an I frame."

Radio Resource Management Timers.

T3101 IMMEDIATE ASSIGNMENT timer
 "MS failed to seize the assigned channel."

T3103 HANDOVER timer
 "MS failed to seize the assigned channel."

T3105 Physical information repetition timer

T3107 ASSIGNMENT COMMAND timer
 "MS failed to seize the assigned channel."

T3109 Loss of communication timer

T3111 Channel deactivation delay timer.

T3113 PAGING REQUEST timer
 "MS did not respond to page."

TT01 TCH loopback timer.

Mobility Management Timers.

T3250 TMSI_REAL_CMD or LOC_UPD_ACC timer
 "MS failed to acknowledge a new TMSI."

T3260 AUTHENT_REQUEST timer
 "MS failed to authenticate."

T3270 IDENTITY_REQUEST timer
 "MS failed to identify."

T3299 HP Unique timer: CIPHER_REQUEST
 "HP 8922M/S failed to configure for ciphering."

Call Control Timers.

| | |
|------|--|
| T301 | Call Received timer "MS failed to connect." |
| T303 | Call Present timer "MS failed to respond to SETUP with CALL_CONF or REL_COMP." |
| T305 | Disconnect Indication timer "MS failed to respond to DISC with REL or DISC." |
| T306 | Disconnect Indication Tone timer "MS failed to respond to DISC with REL or DISC." |
| T308 | Release Request timer "MS failed to respond to REL with REL_COMP or REL." |
| T310 | Incoming call proceeding timer "MS failed to ALERT, CONN or DISC on incoming call." |
| T313 | Connect Indication timer "MS failed to respond to CON with CON_ACK." |
| T323 | Modify Request timer "MS failed to respond to MOD with MOD_COMP or MOD_REJ." |

Timer Values

The timer values have been set as follows:

Table 2-1

Timer Values

| Timer | Value (ms) | Timer | Value (ms) | Timer | Value (ms) |
|-------|----------------|-------|------------|-------|------------|
| T100 | 5000 | T3113 | 8000 | T303 | 10000 |
| T200 | 0 ^a | TT01 | 2000 | T305 | 10000 |
| | | | | T306 | 10000 |
| T3101 | 5000 | T3250 | 5000 | T308 | 10000 |
| T3103 | 5000 | T3260 | 5000 | T310 | 10000 |
| T3105 | 50 | T3270 | 5000 | T313 | 10000 |
| T3107 | 5000 | T3299 | 5000 | T323 | 10000 |
| T3109 | 5000 | | | | |
| T3111 | 500 | T301 | 20000 | | |

a. varies with channel type; see Rec. 04.06 Table 9

Disconnects

Physical Layer Disconnects

Physical Hardware interface layer error codes are proprietary to the Agilent 8922M/S. The defined error codes are as follows:

"Call disconnected: PH Error: 0x00??"

Causes:

| | |
|-----------------|---|
| 0x0096 - 0x009c | Channel or Speech coder failure. |
| 0x009d | Channel coder auto recovery to BCCH. [Non-fatal] |
| 0x009e | Channel coder failed, cycle power to recover. [Fatal] |
| 0x009f | Channel coder BCH hang up recovery. [Non-fatal] |
| 0x00a0 | Channel coder failure, BCH hang up. Cycle power to recover. [Fatal] |
| 0x00a2 | Channel coder failure. |
| 0x00a3 | Speech coder failure. |
| 0x00a5 | Invalid GSM Protocol Processor ROMS. |
| 0x00a6 | RTI failed to configure. |
| 0x00a7 | Channel or Speech coder failed to boot. |
| 0x00aa | Channel or Speech coder I/O overloaded. |
| 0x00ab | T100 expired. |
| 0x00ac | Protocol Message Allocation failed. |

Data Link Layer Disconnects

Data Link layer error codes are proprietary to the Agilent 8922M/S. The defined error codes are as follows:

"Call disconnected: DL Error: 0x00??"

Causes:

| | |
|--------|---------------------------------------|
| 0x00c8 | SAPI incorrect. |
| 0x00c9 | Timer T200 expired. |
| 0x00ca | Re-establish link. |
| 0x00cb | Unexpected UA response. |
| 0x00cc | Unexpected DM response. |
| 0x00cd | Unexpected DM response in multiframe. |
| 0x00ce | Unexpected S frame. |
| 0x00cf | Frames out of sequence. |
| 0x00d0 | Bad parameters in U frame. |
| 0x00d1 | Bad parameters in S frame. |
| 0x00d2 | Bad M bit in I frame. |
| 0x00d3 | I frame length incorrect. |
| 0x00d4 | Invalid frame. |
| 0x00d5 | Unexpected SABM. |
| 0x00d6 | SABM in I frame. |
| 0x00d7 | Unexpected release. |

**Radio Resource
Layer Disconnects**

The RR sub-layer only generates timer expiry error codes.

"Call disconnected: RR Error: 0x00??"

Causes:

No RR reports are supported.

**Mobility
Management Layer
Disconnects**

Mobility Management sub-layer error codes are proprietary to the Agilent 8922M/S.
The defined error codes are as follows:

"Call disconnected: MM Error: 0x00??"

Causes:

| | |
|--------|---------------------------------|
| 0x0001 | Authorization procedure failed. |
| 0x0002 | MS rejected. |

**Call Control Layer
Disconnects**

Call Control sub-layer error codes are actually CC cause values as defined by Rec. 04.08 Table 10.53. The cause values used by the Agilent 8922M/S are as follows:

"Call disconnected: CC Cause: 0x00??"

Causes:

| | |
|--------|---|
| 0x0001 | Unassigned number. |
| 0x0002 | No route to specified transit network. |
| 0x0003 | No route to destination. |
| 0x0006 | Channel unacceptable. |
| 0x0010 | Normal call clearing. |
| 0x0011 | User busy. |
| 0x0012 | User not responding. |
| 0x0013 | User no answer. |
| 0x0015 | Call rejected no good reason. |
| 0x0016 | Number changed. |
| 0x001b | Destination out of order. |
| 0x001c | Invalid number. |
| 0x001e | Response to STATUS_ENQUIRY. |
| 0x001f | Normal, unspecified. |
| 0x0022 | No circuit/channel available. |
| 0x0026 | Network out of order. |
| 0x0029 | Network temporary failure. |
| 0x002a | Switching equipment congestion. |
| 0x002b | Access information discarded. |
| 0x002c | Requested circuit/channel not available. |
| 0x002f | Resource unavailable, unspecified. |
| 0x0039 | Bearer capability not authorized. |
| 0x003a | Bearer capability not available. |
| 0x003f | Service or option not available, unspecified. |
| 0x0041 | Bearer service not implemented. |
| 0x0046 | Only restricted digital information bearer capability is available. |
| 0x004f | Service or option not implemented, unspecified. |

Messages
Disconnects

| | |
|--------|---|
| 0x0051 | Invalid call reference value. |
| 0x0058 | Incompatible destination. |
| 0x005f | Invalid message, unspecified. |
| 0x0060 | Mandatory information element error. |
| 0x0061 | Message type non-existent or not implemented. |
| 0x0062 | Message not compatible with call state or message type non-existent or not implemented. |
| 0x0063 | Information element non-existent or not implemented. |
| 0x0064 | Invalid information element contents. |
| 0x0065 | Message not compatible with call state. |
| 0x0066 | Recovery on timer expiry. |
| 0x006f | Protocol error, unspecified. |
| 0x007f | Interworking, unspecified. |

Host I/O Error:

"Call disconnected: Host I/O Error."

**Operating System
Error:**

"Call disconnected: Operating System Error."

Unknown Errors:

"Call disconnected: 0x00??"

Protocol Log Examples Of Typical Calls.

We often have requests for ‘What is a good call supposed to look like?’. In appendix A you will find the complete Common Air Interface protocol log of a typical call. It includes: Call Setup, Intra-cell Handover, Inter-cell Handover, Single TCH, Hopped TCH, and Call Termination. The log shown was obtained using a PC Protocol Logger attached to the Protocol Interface.

Appendix A details how to set up Protocol Logging.

The sample protocol log of the Common Air Interface was obtained using the LOGGING Pass_Filter set to: ‘+Service’. The system parameters used were the Agilent 8922M/S power on defaults except for changing TCH2 to use MA2. Only OSI Control Stack traffic is shown. Management stack traffic configuring the Agilent 8922M/S is not shown. Note that a mobile may ‘piggyback’ an acknowledgment on a following I frame rather than use the explicit RR frame. Some service primitives used are proprietary to the Agilent 8922M/S. Layer 3 messages are accompanied by the full L3 message in HEX format.

Monitoring For Protocol Failure And Recovery During Test.

The Agilent 8922M/S provides error reporting for protocol errors. These errors may be due to mobile failure, base station failure or a faulty user configuration. It is wise to query the error messages periodically. Particularly errors should be queried prior to call setup, after call termination and after a handover.

When the error: 'Call disconnected: PH Error: 0x009d' (or 0x009f) is encountered, a fatal protocol error has been detected by the Agilent 8922M/S and it has reconfigured back to the BCCH. Testing may resume from a point at which the mobile is camped.

When the error: 'Call disconnected: PH Error: 0x009e' (or 0x00a0) is encountered, a fatal protocol error has been detected which requires cycling power on the Agilent 8922M/S.

Instrument BASIC

Agilent Technologies 8922M/S Instrument BASIC Overview

The Agilent 8922M/S contains an HP Instrument BASIC computer that can run programs to control the Agilent 8922M/S and any connected GPIB equipped instruments. This provides a powerful test instrument and test system controller in one package.

Programs can be written on an external computer and loaded into the Agilent 8922M/S, or can be typed directly into the Agilent 8922M/S's Instrument BASIC computer. Programs can then be stored on memory cards.

IBASIC

The rest of this section of the manual refers to the HP Instrument BASIC Language known as **IBASIC**.

In This Chapter

The information in this chapter is divided into two broad categories: general information about IBASIC, and information about IBASIC programming using the TESTS subsystem.

The general information category contains four sections:

- Configuration and Instrument Control
- Loading, Storing, and Running
- Entering and Editing Programs
- Memory Cards

The IBASIC programming category contains information on structuring IBASIC programs to run in the TESTS subsystem and some of the features of the TESTS subsystem that can be used in writing programs.

The IBASIC programming category contains one section:

- Programming and Using the TESTS Subsystem

The TESTS Subsystem and IBASIC

The Agilent 8922M/S's IBASIC computer is the "core" of an automated test environment referred to as the TESTS subsystem. This environment is available by accessing the **TESTS** screen.

Programs can also be written that do not use the special TESTS subsystem capabilities, using only the IBASIC computer core.

Programs That Use the TESTS Subsystem

The TESTS subsystem's capabilities were designed to allow the operator to "pick and choose" the tests and parameters they need from a larger set, eliminating unnecessary tests and reducing test time. This is especially helpful when a very large program has been written containing several tests and a multitude of associated specifications, test parameters and frequencies.

Writing programs to run in this environment requires you to understand and adhere to the program structure and syntax required by the TESTS subsystem.

Programs That Do Not Use the TESTS Subsystem

If you have a common test routine that uses the same tests and parameters every time it is run, it may be easier to write your test program to run directly in the IBASIC computer without using the TESTS subsystem.

These programs are much like any stand-alone program, and development of these programs will not be covered by this chapter. All of the general information sections of this chapter can be applied to these types of IBASIC programs.

By writing tests that do not use the TESTS subsystem, you lose the ability to easily access and change the test order and associated parameters with the subsystem's editing screens (although you can write your program to provide operator input during the test to change parameters).

Configuration and Instrument Control

Controlling HP 8922M/S Functions

The Agilent 8922M/S's IBASIC computer acts much like a system controller connected by a GPIB cable to the Agilent 8922M/S; but instead of a cable, the Agilent 8922M/S has its own internal control bus connected to the IBASIC controller.

The internal bus address is **8xx**. (xx is any valid GPIB address.) When you write programs to run on the Agilent 8922M/S's IBASIC computer to address Agilent 8922M/S functions, you must use the "8xx" address to output commands.

For example, if you want a program in the IBASIC computer to reset the Agilent 8922M/S at the start of a test procedure, the program code to do this would be written **OUTPUT 814;"*RST"**

Controlling Connected Instruments

When the Agilent 8922M/S's GPIB **Mode** field, on the I/O Configure screen is set to Control, it takes on the role of system controller. This allows it to control other test instruments connected by GPIB cables.

Instruments controlled by the Agilent 8922M/S use the normal **7xx** GPIB address prefix.

For example, if two Agilent 8922M/S's are used in a test system, and the second instrument's GPIB address is 715, a program running in the *controlling* Agilent 8922M/S would output the command **OUTPUT 715;"*RST"** to reset the *controlled* Agilent 8922M/S.

NOTE

Multiple Controllers Only one system controller can be connected to the bus at any time. If the Agilent 8922M/S is used in a test system that has its own controller, the Agilent 8922M/S can not be used as a controller unless the system controller is turned off or disconnected from the bus.

NOTE

If an Agilent 8922M/S is used as a controller in a system with another Agilent 8922M/S, the GPIB **Mode** of the non-controller Agilent 8922M/S must be set to Talk&Listen.

Hardware Connections and Agilent 8922M/S Configuration

Agilent 8922M/S provides an RS-232 Serial port and an GPIB port for a variety of uses:

- Controlling the Agilent 8922M/S using a connected controller
- Controlling connected instruments using the Agilent 8922M/S IBASIC computer
- Printing screen images and test results
- Entering and editing IBASIC programs

The Agilent 8922M/S's **I/O CONFIGURE** screen is used to configure these ports for the desired use.

GPIB Configuration For Programming

- 1 Access the Agilent 8922M/S's **I/O CONFIGURE** screen.
- 2 Set the **HP-IB Adrs** to the desired address.
- 3 Set the **Mode** field to Talk&Lstn.
- 4 Enter the **Print Adrs** if a GPIB printer is connected.
 - 1 Set the **Printer Port** field to HPIB.
- 5 Connect GPIB cables to other instrument(s).

This configuration prepares the Agilent 8922M/S to be controlled by a system controller, allowing program transfers over the bus. Refer to "Entering and Editing Programs" on page 8-16, to start programming or editing.

**Serial Port
 Configuration for
 Programming**

Connecting the Serial Port

- 1 Connect an RJ-11/RS-232 adapter (Agilent P/N 98642-66508) to the 25-pin RS-232 connector of your terminal or personal computer (PC). (If your PC has a 9-pin RS-232 port, use the appropriate adapter and use the table below to verify connections.)
- 2 Connect a 4-conductor RJ-11 cable (Agilent P/N 98642-66505) from the adapter to the Serial Port of the Agilent 8922M/S.

NOTE

RJ-11 Connectors RJ-11 cables and adapters can be wired differently. If you buy a cable or adapter from a supplier other than Agilent, verify the connections for the pins indicated in the following table before connecting cables to the instruments.

| Agilent 8922M/S RJ-11 Serial Port | | Terminal/PC 25-Pin RS-232 | | Terminal/PC 9-Pin RS-232 |
|--------------------------------------|----|------------------------------|----|-----------------------------|
| Pin 2 (RX) | to | pin 2 (TX) | or | pin 3 (TX) |
| Pin 5 (TX) | to | pin 3 (RX) | or | pin 2 (RX) |
| Pin 4 (GND) | to | pin 7 (GND) | or | pin 5 (GND) |

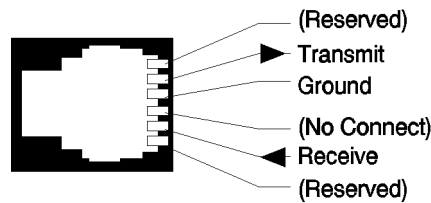

Figure 8-1

Serial Port Connections

Configuring the Agilent 8922M/S

- 1 Access the Agilent 8922M/S's **I/O CONFIGURE** screen.
- 2 Set **Serial In** field to **Inst** to allow the Agilent 8922M/S's IBASIC controller to accept characters from a PC or ASCII terminal.
- 3 Set **IBASIC Echo** to **On**.
- 4 Set **Inst Echo** to **On**.
- 5 Set the **Serial Baud** to 4800. (Baud can be altered as required by your terminal.)
- 6 Set **Parity** field to **None**.
- 7 Set **Data Length** to 8 bits.
- 8 Set **Stop Length** to 1 bit.
- 9 Set **Rcv Pace** to **None**.
- 10 Set **Xmt Pace** to **Xon/Xoff**.

Configuring Your Terminal or PC

Configuring an ANSI Terminal

- 1 Select **ANSI** operating mode.
- 2 Set **Baud Rate** to **4800** (if this rate is not available on your terminal, set it to a rate that can be selected on the Agilent 8922M/S's **I/O CONFIGURE** screen).
- 3 Set **Parity** to **none**.
- 4 Set **Data Bits** to **8**.
- 5 Set **AnqAck** to **no** (or **none**).
- 6 Set **Receive/Transmit Pacing** to match the Agilent 8922M/S's settings.

Your terminal may have additional fields available for different configurations, but should be able to communicate with the Agilent 8922M/S if these settings are made.

Configuring an IBM-Compatible PC With HP AdvanceLink

HP AdvanceLink is a popular PC terminal emulator used to emulate a variety of terminals. If you are using a different terminal emulator program on a PC, configure it using the above settings.

Instrument BASIC

Configuration and Instrument Control

- 1 Load and run HP AdvanceLink on your PC.
- 2 Set the *Global Configuration* settings.
 - a Keyboard: USASCII
 - b Personality: HP
 - c Language: ENGLISH
 - d Terminal Mode: Alphanumeric
 - e Remote To: (Enter your PC's serial port number.)
 - f Printer I/F: None
 - g Memory Size: 32K
 - h Plotter I/F: None
 - i HP Mode: Yes
 - j Video Type: (Select your display type.)
 - k Forms Path: (Enter path if used.)
 - l Screen Size: (Enter the size.)
- 3 Set the *Terminal Configuration* settings.
 - a Terminal ID: 2392A
 - b Local Echo: OFF
 - c CapsLock: OFF
 - d Start Col: 01
 - e Bell: ON
 - f XmitFnctn(A): NO
 - g SPOW(B): NO
 - h InHcolWrp(C): NO
 - i Line/Page(D): LINE
 - j InHndShk(G): No
 - k InH DC2(H): NO
 - l Esc Xfer(N): YES
 - m ASCII 8 Bits: YES
 - n FldSeperator: US
 - o BlkTerminator: RS
 - p ReturnDef: CR
 - q Copy: Fields
 - r Type Ahead: No
 - s ROW Size: 80
 - t Host Prompt Character: D1
 - u Horiz. Scrolling Increment: 08
 - v Large [+] Key: +
- 4 Set the *Remote Configuration* settings
 - a Baud Rate: 4800
 - b Parity/Data Bits: None/8
 - c Eng Ack: No
 - d Asterisk: OFF
 - e Chk Parity: NO
 - f SR(CH): LO
 - g Recv Pace: None
 - h Xmit Pace: None
 - i CS(CB)Xmit: No

**Verifying Serial Port
to IBASIC
Operation**

- 1 Access the Agilent 8922M/S's **TESTS** screen.
- 2 Select IBASIC from the **Test Function** field to access the **IBASIC Controller** screen.
- 3 Position the cursor in the top left corner of the screen. (The top of the screen contains two command lines for entering commands and editing code.)
- 4 Type **SCRATCH**, **(ENTER)**: *Note - this clears any existing programs in memory.*
- 5 Type **10 PRINT "HELLO WORLD"**, **(ENTER)**.
- 6 Type **20 END**, **(ENTER)**.
- 7 Press **(L1)** on the Agilent 8922M/S (or type **RUN**, **(ENTER)** on your terminal) to run this two line program.
- 8 **HELLO WORLD** should be displayed on the Agilent 8922M/S and the terminal/PC's screen.

After the cable and adapter have been connected, and the Agilent 8922M/S and terminal (or PC) have been configured, you should be able to type on your terminal's keyboard and "talk" to the Agilent 8922M/S.

As you type each command, the letters appear on the Agilent 8922M/S's command lines and the terminal/PC screen. The letters appear on the terminal/PC screen because the **Inst Echo** field in the **I/O CONFIGURE** screen is set to **On**.

When the program is run, **HELLO WORLD** appears on the Agilent 8922M/S's display area and on the terminal/PC's screen because the **IBASIC Echo** field in the **CONFIGURE** screen is **On**. Any non-graphic character that is printed to the Agilent 8922M/S's display area during a "print-to-screen" operation (**CAT**, **LIST**, **PRINT**,..) is also printed to the terminal/PC.

Refer to "Entering and Editing Programs" on page 8-16, to start programming or editing.

Loading, Storing, and Running

This section describes loading, storing, and running both IBASIC programs and test procedures using the TESTS subsystem.

Loading An IBASIC Program From A Memory Card

- 1 Insert the memory card.
- 2 Access the **IBASIC Controller** screen from the Test Function field on the **TESTS** screen.
- 3 Using the knob, select the field and enter the following command to load your program:

```
GET "<filename>:INTERNAL"
```

Loading an IBASIC Program From A GPIB Disk Drive

- 1 Insert the disk into the drive.
- 2 Access the IBASIC controller screen from the Test Function field on the TESTS screen.
- 3 Using the knob, select the field and enter the following command to load your program:

```
LOAD "<filename>:7xx,x"
```

Downloading An IBASIC Program Into the Agilent 8922M/S

This procedure downloads an IBASIC program from your connected IBASIC computer to the Agilent 8922M/S's IBASIC Controller. This procedure assumes your Agilent 8922M/S's GPIB address is set to **14**.

- 1 Access the Agilent 8922M/S's **IBASIC Controller** screen.
- 2 Load your IBASIC program into your connected IBASIC computer.
- 3 Enter the following commands on your IBASIC computer to copy the program into the Agilent 8922M/S's IBASIC Controller:

```
OUTPUT 714;"PROG:DEL" <enter>  
OUTPUT 714;"PROG:DEF #0" <enter>  
LIST #714 <enter>  
OUTPUT 714;" "END <enter>
```

Storing IBASIC Programs On Memory Cards

- 1 Use the previous procedure to download your program into the Agilent 8922M/S's RAM.
- 2 Press **LOCAL**, **SHIFT**, **CANCEL** on the Agilent 8922M/S to perform an IBASIC reset.
- 3 If your memory card has not been initialized, insert your memory card into the Agilent 8922M/S and enter the following command on your computer:

```
OUTPUT 714;"PROG:EXEC `INITIALIZE"" :INTERNAL"" ""
```
- 4 Insert the initialized memory card into the Agilent 8922M/S.
- 5 Define the memory card as the Mass Storage device by entering the following command on your computer:

```
OUTPUT 714;"PROG:EXEC `MSI "" :INTERNAL"" ""
```
- 6 Save your program to the memory card by entering the following command on your computer:

```
OUTPUT 714;"PROG:EXEC `SAVE ""<filename>"" ""
```
- 7 Press **LOCAL**.

Storing an IBASIC Program On A GPIB Disk Drive

- 1 Insert the disk into the drive.
- 2 Access the IBASIC controller screen from the Test Function field on the TESTS screen.
- 3 Using the knob, select the field and enter the following command to save your program:

```
STORE "<filename>:7xx,x"
```

Running Your Program

Once the program is loaded into the **IBASIC Controller's** RAM, it can be run by using the knob to enter the **RUN** command, or by selecting the Run field in the top right corner of the screen.

Loading a Test Procedure

A Test Procedure file includes all the user defined channels, frequencies, limits, and values from the Test Executive for the radio under test. You can make as many Test Procedure files as needed for the different radios you are testing.

- 1 Press the front-panel **TESTS** key and select the **Location** field. Refer to item (1), see Figure 8-2 on page 8-12.
- 2 Choose the location (Card, ROM, RAM, or Disk) where the Test Procedure is found. Refer to item (2), see Figure 8-2 on page 8-12. (The location you select appears in the field (1) area.)

Instrument BASIC
Loading, Storing, and Running

| | | | |
|-----------------------------|------------------------|-------------------|-----------|
| Procedure: Location Library | TESTS | Program Autostart | Run Test |
| : ROM | | : Off/On | Continue |
| Comment | | | Edit Sean |
| | | | Edit Parm |
| | | | Edit Spec |
| Test Execution Conditions | | | Choices: |
| On UUT Failure | Run Mode | | Card |
| Continue/Stop | Continuous/Single Step | | ROM |
| Output Results | Output Destination | | RAM |
| All/Failures | Crt/Printer | | Disk |
| Output Heading | | | |
| | | | |
| Test Function | | | |
| Edit Sean | | | |

Figure 8-2 Loading a Test Procedure

- 3 Select the **Procedure** field. Refer to item (3), see Figure 8-3 on page 8-13.
- 4 Choose the Test Procedure file that you want to download. Refer to item (4), see Figure 8-3 on page 8-13. (The Test Procedure you select appears in the field (3) area.)
- 5 Read the **Comment** field to ensure that the loaded Test Procedure file is the one you want. Refer to item (5), see Figure 8-3 on page 8-13.

NOTE

The Test Procedure file should have a Test Library file with the same name. Refer to the *Programming and Using the TEST Subsystem* for descriptions of Test Procedure and Library files, and how these files relate to the program's code file.

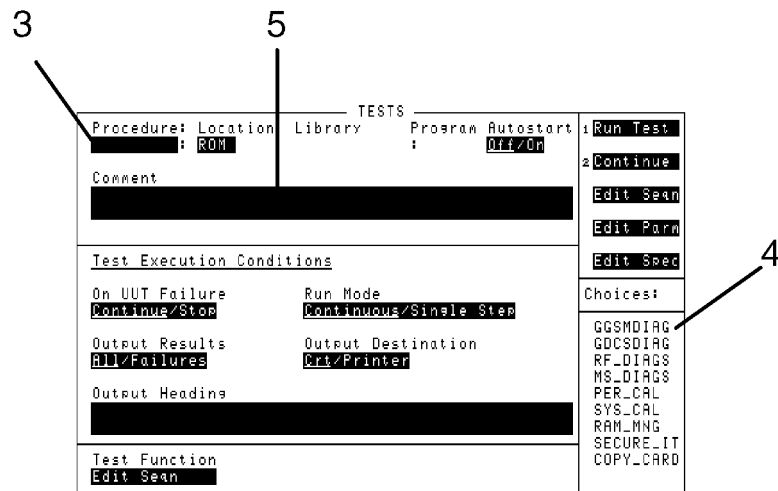

Figure 8-3 Loading a Test Procedure

- Making or Deleting Test Procedure Files**
- 1 Select the front-panel **TESTS** key, and then select the **Test Function** field shown by item (1), see Figure 8-4 on page 8-14.
 - 2 Select **Proc Mngr** shown by item (2), see Figure 8-4 on page 8-14.

Instrument BASIC
Loading, Storing, and Running

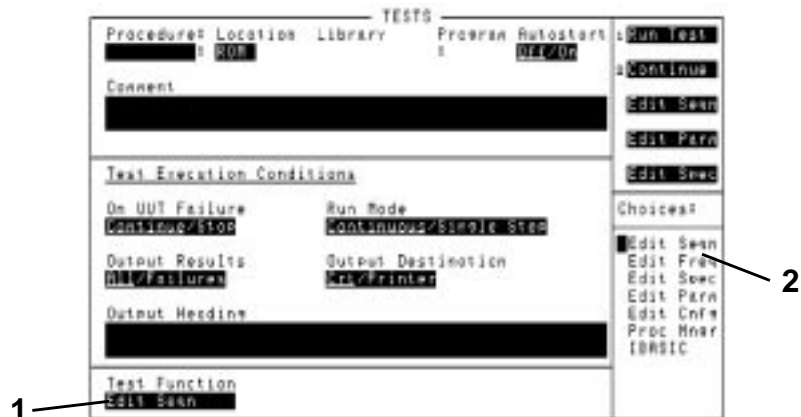

Figure 8-4 Test Procedure and Test Library Files

- 3 Select the **Procedure** field shown by item (3), see Figure 8-5 on page 8-15.
- 4 Enter the Test Procedure filename that you want to make or delete by using the alpha/numeric list of characters shown by item (4), see Figure 8-5 on page 8-15.
- 5 Select the **Location to Make or Delete** field shown by item (5), see Figure 8-5 on page 8-15, then select the file's location to be on memory card, RAM, or Disk from the list of choices shown in item (4).
- 6 Enter up to two lines of comments to identify the new Test Procedure. Refer to item (6), see Figure 8-5 on page 8-15.
- 7 Select whether the new Test Procedure will use the current Test Library or if it will use no library as shown by item (7), see Figure 8-5 on page 8-15.
- 8 Select where the program for the Test Procedure is to be found. Refer to item (8), see Figure 8-5 on page 8-15.
- 9 Select the **Make Procedure** field or the **Delete Procedure** field as shown in item (9).

Use the **Pass Number** field in the lower-right corner of the Procedure Manager menu to unsecure a Test Procedure file. The ROM program **SECURE_IT** is used to secure Test Procedure files.

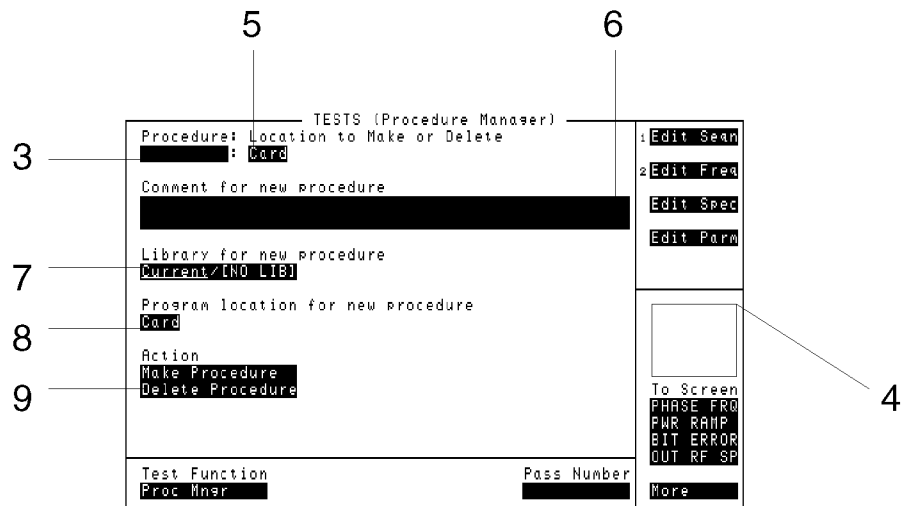

Figure 8-5 Making a Test Procedure File

Running a Test Sequence

- 1 Select the Run Test field.
- 2 Follow directions and prompts on the Agilent 8922M/S screen according to the test sequence being run.
- 3 When testing is complete, the Agilent 8922M/S will respond to front panel or remote input. If at any time you need to stop testing, press the front-panel **CANCEL** key.

NOTE

A program takes up to 3 minutes to load into the Agilent 8922M/S and is loaded when the Run Test field is first pressed.

Press the front-panel **SHIFT** **CANCEL** keys to abort from an error condition or to abort from the program. When you abort from loading the program, you'll need to clear Agilent 8922M/S RAM memory in order to correctly re-load the program at a later time.

To clear Agilent 8922M/S RAM, select and run the ROM program **COPY_PL** from the **Procedure** field in the **TESTS** menu. (Running **COPY_PL** deletes all **SAVE/RECALL** registers. So instead you may want to load another program, run it, and then re-load the original program that was aborted.

Entering and Editing Programs

The **IBASIC Controller** screen is the “computer” for the TESTS subsystem. You enter and edit programs just like any other IBASIC computer, with the exceptions that the Agilent 8922M/S does not have a computer keyboard connected directly to it, and full screen editing does not yet exist.

Programs can be entered into the IBASIC computer’s RAM using a variety of methods:

- Using the IBASIC Controller screen and the Cursor Control knob.
- Using an external IBASIC controller connected to the Agilent 8922M/S by GPIB.
- Using an external ASCII terminal or Personal Computer (PC) connected to the Agilent 8922M/S by RS-232.

Accessing the Agilent 8922M/S’s IBASIC Controller

- 1 Access the **TESTS** screen by pressing **TESTS**.
- 2 Select the **Test Function** field at the bottom of the screen to display a list of choices.
- 3 Select IBASIC to display the **IBASIC Controller** screen.

Using the Knob

After accessing the **IBASIC Controller** screen, position the cursor in front of the command line at the top of the screen and press the Cursor Control knob. A list of characters is displayed that you select from to enter your commands. A maximum of 100 characters may be entered into the command line. After the command is entered on the command line, select ‘Done’ at the top of the list of characters to execute it.

Commands and program lines are entered just as you would enter them using a keyboard. For example, to set the default mass storage device to the memory card slot, you would enter the command

```
MSI ":INTERNAL"  
and select ‘Done’
```

To list the contents of the default mass storage device, enter

```
CAT  
and select ‘Done’.
```

Using HP-IB

The easiest way to enter and edit a program is to create it on your computer, using your computer's editing features, and then download it into the Agilent 8922M/S. The usual development sequence is:

- 1 Write the program on your computer to control the Agilent 8922M/S using the normal **7xx** GPIB address.
- 2 Run the program to verify that it controls the Agilent 8922M/S correctly.
- 3 Change the Agilent 8922M/S's GPIB address in your program to **8xx**.
- 4 Download the program into the Agilent 8922M/S. (See Downloading a Program Into the Agilent 8922M/S.)
- 5 Run the program on the Agilent 8922M/S to verify correct operation.
- 6 Copy the program to a memory card for future use.

PROGRAM Interface Commands

The Agilent 8922M/S's IBASIC Controller has a special Program Interface it uses to communicate with other computers over GPIB. When sending a command to the Agilent 8922M/S from another computer, you must use a 'PROG' command to tell the Agilent 8922M/S you need it to perform an operation.

In the following list, 'Addr' is the address of the Agilent 8922M/S, and '<filename>' represents the name of the file you are saving or retrieving.

NOTE

For more information on memory cards, see the Memory Cards section.

To initialize a memory card use this command:

```
OUTPUT Addr;"PROG:EXEC `INITIALIZE ``:INTERNAL"" ""
```

To change the default Mass Storage device use this command:

```
OUTPUT Addr;"PROG:EXEC `MSI ``:INTERNAL"" ""
```

To save a file to the default Mass Storage device, use this command:

```
OUTPUT Addr;"PROG:EXEC `SAVE ``<filename>"" ""
```

To retrieve a file from the default Mass Storage device, use this command:

```
OUTPUT Addr;"PROG:EXEC `GET ``<filename>"" ""
```

Instrument BASIC

Entering and Editing Programs

Other PROG Commands

Two additional PROG Commands are used to prepare the Agilent 8922M/S's IBASIC Controller RAM for receiving programs.

```
OUTPUT Addr;"PROG:DEL"
```

deletes any programs currently residing in RAM.

```
OUTPUT Addr;"PROG:DEF #0"
```

defines the address in RAM where a downloaded program will be stored.

Preparing the Agilent 8922M/S to Receive Programs

- 1 Configure the GPIB port as described in this chapter, 'GPIB Configuration For Programming' on page 8-5.
- 2 Access the **IBASIC Controller** screen.

Downloading A Program Into the Agilent 8922M/S

This procedure assumes your Agilent 8922M/S's GPIB address is **14**. If it is not, change the address in the following procedure to match your instrument's address.

- 1 Load the IBASIC program to be downloaded into your controller.
- 2 Enter these commands to transfer the program to the Agilent 8922M/S:

```
10 DIM LINE$(200), FILE_NAME$(120)
20 Addr=714
30 INPUT "NAME OF (ASCII) IBASIC FILE TO DOWN-      LOAD?", FILE_NAME
$
40 ASSIGN @FILE TO FILE_NAME$; FORMAT ON
50 ON END @FILE GOTO DONE
60 OUTPUT Addr;"PROG:DEL"
70 OUTPUT Addr;"PROG:DEF #0"
80 WHILE (1)
90 ENTER @FILE; LINE$
100 OUTPUT Addr; LINE$
110 END WHILE
120 DONE: !
130 OUTPUT Addr; " " END
140 PRINT "Done with down-load"
150 END
```

Figure 8-6

Download Program for Computers using GPIB

To verify that your code was downloaded, type in the command- **OUTPUT 714;"PROG:EXEC \LIST ' ' .** Your program should be listed on the Agilent 8922M/S's **IBASIC Controller** screen.

Line-by-line Entry and Editing

Program lines in the Agilent 8922M/S's RAM can be entered and edited one line at a time from your computer using the PROG command -

```
OUTPUT Addr;"PROG:EXEC `<program line/command> '"
```

with `<program/command>` representing any command or program line you want to enter.

For example, to enter or change line 20 of a program to '20 A=3.14', you would enter the following command on your computer

```
OUTPUT Addr;"PROG:EXEC `20 A=3.14` '"
```

Quoted strings, such as those used in PRINT commands, must use double quotes. Example -

```
OUTPUT Addr;"PROG:EXEC `30 PRINT ""TEST""` '"
```

Using a Terminal

A connected terminal, or PC using a terminal emulator, is used to enter characters directly into the Agilent 8922M/S IBASIC Controller's command line.

Editing a program line requires you to re-enter the full line with corrections.

Configuring your terminal/PC for this operation is explained in this chapter, 'Serial Port Configuration for Programming' on page 8-6.

Entering Commands

When program lines or commands are entered, you press the ENTER key on your terminal to execute the command. For example, to LIST a program in RAM you would type LIST, **ENTER**

This differs from using the Cursor Control knob to enter characters where you select 'Done' to execute the command.

Memory Cards

This section contains information about memory cards and about programming the Agilent 8922M/S. You are also shown how to connect a radio to the Agilent 8922M/S in order to run automated tests from the main radio-test screen (referred to as the “Test Executive”).

This section covers:

- *Using the Memory Card* – Inserting and removing memory cards, setting write protection, backing up programs, and changing memory-card batteries.
- *Programming the Agilent 8922M/S* – Using HP Instrument BASIC, entering programs, downloading programs over GPIB, editing programs line-by-line over the serial port.
- *Automated Radio Testing* – Connecting radios to the Agilent 8922M/S, and using the Agilent 8922M/S Test Executive to test radios.

Using Memory Cards

Figure 8-7 on page 8-21 illustrates how to insert a memory card into the Agilent 8922M/S front panel. To remove a memory card, simply pull it out. Pay attention to memory-card orientation as it's inserted; otherwise, the card will not be seated correctly in the slot. The memory-card label is marked with an arrow that must be inserted on the same side as the arrow shown on the front-panel slot.

Memory cards may be inserted and removed with the Agilent 8922M/S powered on or off.

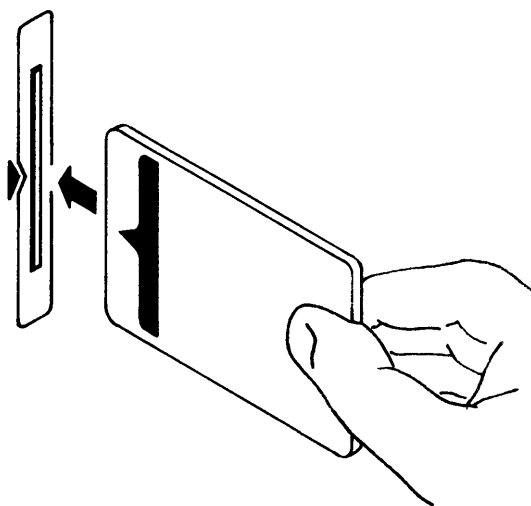

Figure 8-7 **Inserting a Memory Card**

Types of Memory Cards

Two types of memory cards may be purchased from Agilent Technologies as shown in Table 1 on page 8-21:

- SRAM (Static Random-Access Memory), or
- OTP (One-Time Programmable).

Table 1 **Memory Card Part Numbers**

| Memory | Type | Part Number |
|---------------|------|----------------|
| 32 kilobytes | SRAM | Agilent 85700A |
| 128 kilobytes | OTP | Agilent 85701A |
| 128 kilobytes | SRAM | Agilent 85702A |
| 256 kilobytes | OTP | Agilent 85703A |
| 256 kilobytes | SRAM | Agilent 85704A |
| 512 kilobytes | SRAM | Agilent 85705A |
| 512 kilobytes | OTP | Agilent 85706A |

SRAM memory cards require a battery to maintain stored information. OTP memory cards do not require a battery and will maintain stored information indefinitely.

Initializing an SRAM Memory Card

An SRAM memory card must be initialized before it can be used. Initialize the SRAM memory card by using the **COPY_PL** program (which at the same time you can copy Test Procedure and Test Library files to the memory card). Otherwise, initialize the SRAM card using the IBASIC computer as follows:

- 1 Press the front-panel **TESTS** key and then select the **Test Function** field (lower-left corner of screen).
- 2 Choose IBASIC from the **Choices** menu.
- 3 Select the IBASIC field, then use the knob to type:

INITIALIZE ":INTERNAL"

Then select **Done**.

The initialization process takes only a second to complete.

- 4 Ensure that the SRAM memory card is initialized. Select the IBASIC field, then use the knob to type:

CAT

Then select **Done**.

Information for the initialized memory card should appear on the screen.

If the error message "**ERROR 85 Medium uninitialized**" appears on the screen, check the SRAM battery to ensure that it's charged and that its polarity is correctly oriented in the battery holder.

Setting the Write-Protect Switch

The SRAM memory card's write-protect switch lets you secure its contents from being accidentally overwritten or erased. The switch has two positions as illustrated in Figure 8-8 on page 8-23:

- *Read-write* – The memory-card contents can be changed or erased, and new files may be written on the card.
- *Read-only* – The memory-card contents can be read by the Agilent 8922M/S, but cannot be changed or erased.

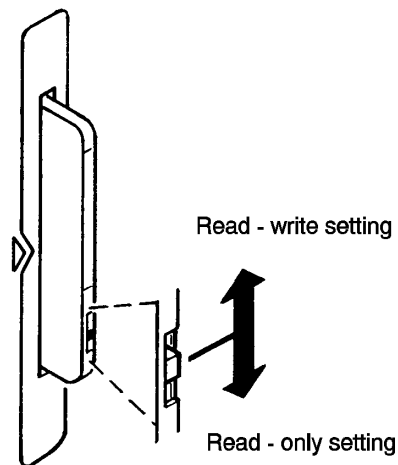

Figure 8-8 **Setting the SRAM Write-Protect Switch**

Backing Up the Memory-Card Programs

SRAM memory cards contain a battery to preserve its contents when the Agilent 8922M/S is turned off or when the card is removed. Memory-card contents may be backed up using the following procedure:

Procedure for Backing Up a Memory Card

The program **COPY_PL** on Agilent 8922M/S ROM backs up Test Procedure and Test Library files onto a SRAM memory card. The program **COPY_PL** also lets you to initialize the SRAM memory card. (Code files should reside on OTP memory cards; an external “device programmer” is required to download code files into an OTP memory card.)

Instrument BASIC
Memory Cards

NOTE

Test Procedure files are identified in the IBASIC screen when a catalog (CAT) is done. A lowercase “p” is prefixed to a Test Procedure filename. Test Library filenames are prefixed with a lowercase “l.”

- 1 Press the front-panel **TESTS** key.
- 2 Select the program **COPY_PL** from ROM in the **Procedure** field, and then select the Run Test field. (Refer to ‘*Loading a Test Procedure*’ on page 8-11 for help.)
- 3 Select the Run Test field.
- 4 Read the instructions on the screen and continue with the copy program when you are ready. (Directions are provided on the screen as you continue.)
- 5 Press the front-panel **PREV** key to exit the screen.

The Memory Card Battery

A memory-card battery should last between 3 and 5 years depending on its use. Write the date a battery is installed in the memory card. The date is important for determining when to replace the battery.

When the battery needs replacing, insert the card into the Agilent 8922M/S and turn the **POWER** switch on. An inserted memory card takes power from the Agilent 8922M/S preventing the card's contents from being lost.

Replace the battery as shown in Figure 8-9 on page 8-25 with a 3 volt 2016 coin cell. *Hold the card in with your other hand while pulling the battery out. Also, be sure to install the battery with the side marked "+" on the same side marked "+" on the battery holder.*

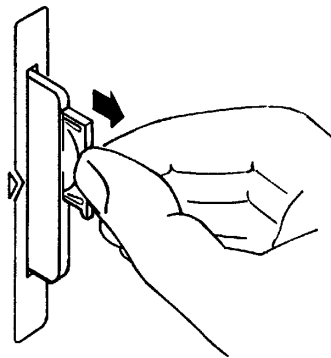

Figure 8-9

Replacing the Memory-Card Battery

Avoid touching the flat sides of the battery when replacing it. Finger oils may contaminate battery contacts in the memory-card.

WARNING

Do not mutilate, puncture, or dispose of batteries in fire. The batteries can burst or explode, releasing hazardous chemicals. Discard unused batteries according to the manufacturer's instructions.

Programming and Using the TESTS Subsystem

This section describes the concepts and tasks associated with the TESTS subsystem. It is intended to help the experienced programmer develop programs, or modify existing programs.

TESTS Subsystem File Descriptions

Three types of files are used in the TESTS subsystem to store different types of information.

Code Files

The first aspect of an automated definition is the code itself. This is just a standard IBASIC Code file that can reside either on the Memory card, on an external disk drive connected to the GPIB port of the Agilent 8922M/S, or in an internal RAM disk. The name of this file is preceded by a lower case 'c'. This tells the TESTS subsystem that this particular file contains program code.

Library Files

A Library indicates all of the available test subroutines in the code, the set of all parameters that might be entered using the user-interface screens, and all specifications that might be used by the subroutines in the code to decide if a test point passes or fails.

Only one Library is defined for each Code file. The name of this file is preceded by a lower case 'l', telling the TESTS system that this is a Library file. Also, both the Library and Code file should have the same base name to indicate the relationship between them.

A Library is required if you want to use the user-interface screen functions of the TESTS subsystem. If the program is simple enough that there is no need for user-input, or if all the user-input is simple enough to be accomplished through INPUT statements, then a [NO LIB] option is available.

Procedure Files

A Procedure allows the user to define which of the test subroutines, parameters, and specifications defined in the Library will be used to test a specific Radio. There may be many Procedures defined that use the same IBASIC Code and Library, each using a different subset of the choices available in the Library. These files are preceded with a lower case 'p', but are *not* required to have the same base name as either the Library or the Code. The name of the corresponding Library (if any) is stored in each Procedure file.

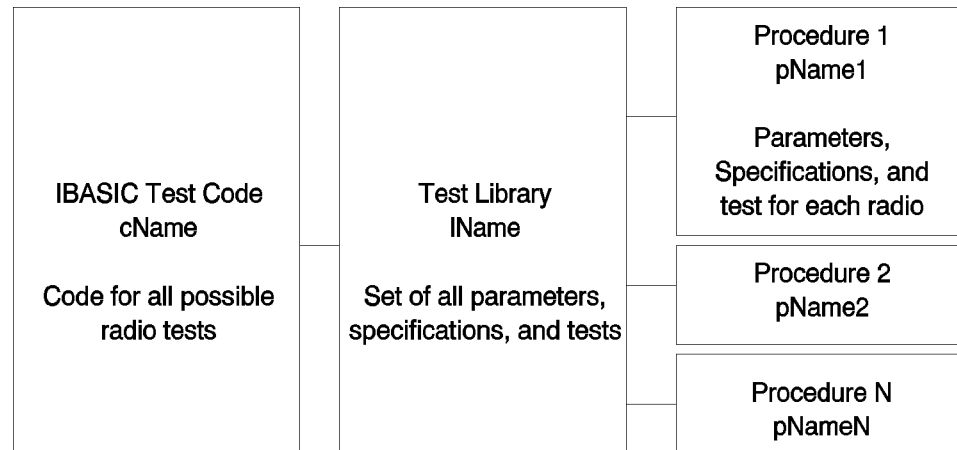

Figure 8-10 TESTS Subsystem File Relationship

TESTS Subsystem Screens The TESTS subsystem uses several screens to create, select, and copy files, and to run tests.

The Main TESTS Subsystem Screen

Refer to Figure 8-11 on page 8-28.

The Main TESTS screen is accessed by pressing the front panel **TESTS** key. Notice that the first line shows the currently selected Procedure. The associated Library is listed, as well as the location of the code.

The comment area is simply available to give the user a more complete explanation of this particular Procedure.

To view all the Procedures available on the selected media, simply select the **Procedure** field. A menu will appear in the lower right corner of the screen, displaying all the Procedures available. This is not a listing of the full contents of the disk; it is only a list of the Procedures that have been stored.

Instrument BASIC
 Programming and Using the TESTS Subsystem

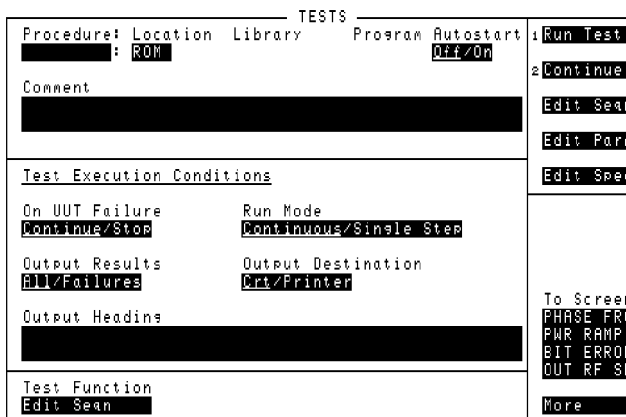

Figure 8-11 The Main TESTS Subsystem Screen

**TESTS Subsystem
 User-Interface
 Screens**

The TESTS subsystem allows the user to easily modify the test subroutines, parameters, specifications and configuration to correspond to the requirements of a specific Radio. There are several user-interface screens that allow the user to do this.

To access any of these screens, select the **Test Function** field at the bottom of the main TESTS screen to display the screen choices.

- The *Edit Sequence* screen lets you select the desired test(s) from the full set of available tests in the default Procedure file.
- The *Edit Specifications* screen defines the specifications used to generate pass/fail messages during testing.
- The *Edit Parameters* screen is used to define instrument settings and characteristics to match those of the radio being tested (audio load impedance, audio power, power supply voltage,..etc.).
- The *Edit Configuration* screen identifies all connected GPIB equipped instruments and their GPIB addresses.
- The *Procedure Manager* screen is used to make or delete Procedures.

IBASIC Programming

IBASIC gives you control over the internal functionality of the Agilent 8922M/S, as well as control over any external instruments connected to the GPIB.

Refer to the Agilent 8922M/S *Agilent Instrument BASIC Programmer's Guide* for details about IBASIC. The manual contains important information about the IBASIC programming-language code, Test Procedure and Test Library file structures, and programming and interfacing techniques.

Program Status

A single-character “run indicator” is displayed in the upper-right corner of the screen to indicate program status:

- If the screen is blank, the program is stopped.
- An asterisk “*”, indicates the program is running or doing other input/output.
- A dash “-” indicates the program is paused.
- A question mark “?” indicates the program is awaiting user input.

Three alpha characters are also displayed in the upper-right corner of the screen to indicate status:

- An “R” indicates the Agilent 8922M/S is in remote operation; the absence of an “R” means the Agilent 8922M/S has changed to local operation.
- An “T” indicates the Agilent 8922M/S is “talking” on the GPIB.
- An “L” indicates the Agilent 8922M/S is “listening” on the GPIB.

Setting Up the Test Execution Conditions.

Five **Test Execution Condition** fields are shown in Figure 8-12 on page 8-30. Set up each field according to your testing needs.

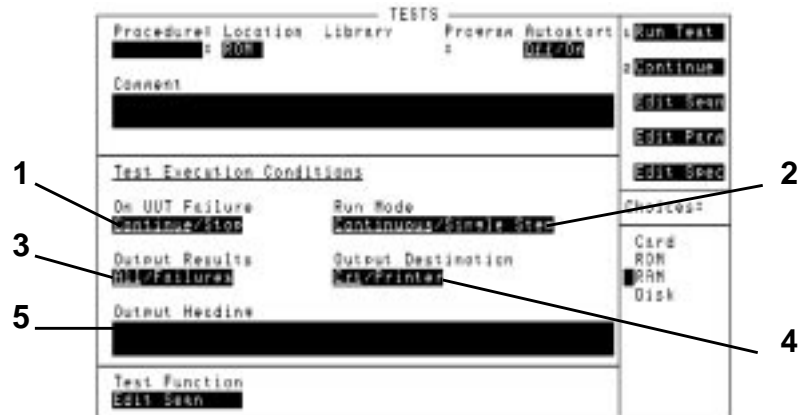

Figure 8-12 Test Execution Conditions

To Have Testing Stop or Continue on a UUT Failure

Refer to item (1) in Figure 8-12 on page 8-30.

On UUT Failure..... Continue

Testing continues whenever the UUT (Unit Under Test) fails to meet its test specification limits. When this occurs, an error is listed on the test-results printout and/or is displayed on the CRT.

On UUT Failure.....Stop

Testing stops whenever the UUT fails to meet test specification limits.

To Continue or Pause After Each Test

Refer to item (2) in Figure 8-12 on page 8-30.

Run Mode.....Continuous

All tests run in sequence. Testing pauses only if the operator is required to interact with the UUT or Agilent 8922M/S; interaction such as changing UUT channels, setting squelch, changing audio level, and so forth, cause testing to pause.

Run Mode.....Single Step

The program stops running at the completion of each test. The test-system operator is prompted to select Continue to proceed with testing.

To Select Printing Conditions

Refer to item (3) in Figure 8-12 on page 8-30.

Output Results.....All

All test results are shown on the output device (CRT and/or printer). Printouts include a “banner” listing the test conditions, measured values, lower and upper limits, and whether the test passed or failed. The **Comment** field is shown at the top along with any identifying information from the **Output Heading** field. Date, and time is also output.

Output Results.....Failures

Test results are shown only when a UUT failure or software error occurs. Printouts include a “banner” listing the test conditions, measured values, and lower and upper limits of the failed test. The **Comment** field and any identifying information from the **Output Heading** field is also output.

To Have Test Results Appear on a CRT or Printer

Refer to item (4) in Figure 8-12 on page 8-30.

Output Destination.....Crt

Test results are output to the Agilent 8922M/S CRT screen only.

Output Destination.....Printer

Test results are output to the CRT and printer. A printer must be correctly configured in order to get a printout.

- To configure an RS-232 printer, refer to chapter 4 for **I/O CONFIGURE** screen descriptions.
- To configure a GPIB printer, refer to the instructions in the following section titled *Configuring External Instruments for GPIB Control*.

To Enter Comments in the Output Heading Field

Refer to item (5) in Figure 8-12 on page 8-30.

- 1 Select the **Output Heading** field. (An alpha/numeric list of characters appears in the lower-right corner of the screen.)
- 2 Select characters one at a time using the knob in order to compose the comment you want to make. (Two lines of comments, 50 characters in length, may be entered.)
- 3 Select **Done** when you are finished.

Instrument BASIC

Programming and Using the TESTS Subsystem

Using Autostart

Ensure the **Autostart** field toggle is set to **On** (see Figure 8-13 on page 8-32 (1)); this allows the Agilent 8922M/S to go straight to the Procedure Menu each time the Agilent 8922M/S is switched on, providing a Memory Card is inserted in the front panel of the Agilent 8922M/S.

If the Procedure Menu screen does not appear on the Agilent 8922M/S display, select **TESTS** and load the procedure.

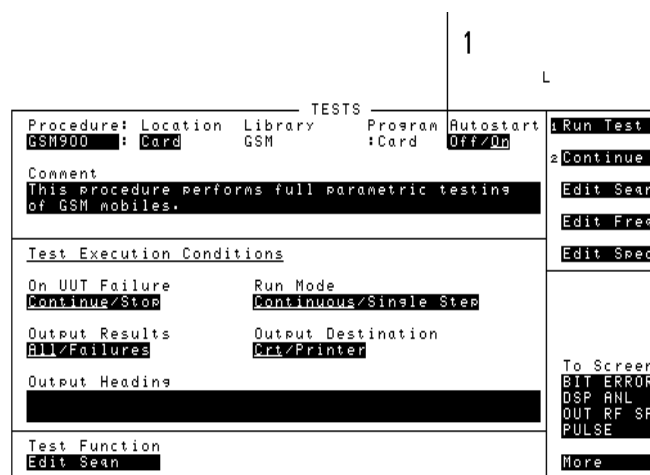

Figure 8-13

Tests Screen of the Agilent 8922M/S

Making a Test Sequence

The Test Sequence menu lets you select radio tests and the order you want them performed.

- 1 Select the Edit Seqn field. A test-sequence screen similar to that shown in Figure 8-14 on page 8-33 appears.
- 2 Select the Insrt Stp field or Delet Stp field as needed to insert or delete tests on the screen. Refer to item (1) in Figure 8-14 on page 8-33.
- 3 Select the **Step #** field and turn the knob to the test you want to change. (As you turn the knob, the test's step number, name, and description changes.)
- 4 Select the **Test Name** field and turn the knob to select the desired test. Refer to item (4) in Figure 8-14 on page 8-33. (As you turn the knob, the test name and description changes along with the test number shown in the **Choices** menu.)

- 5 Select the Yes/No field and decide if the test is to be run on all channels (select **Yes**), or if the test is to be run on prime channels only (select **No**). (Prime channels are selected from the Edit Freq field.)

Four factors determine how long it takes to test a radio:

- The number of tests selected in the sequence.
- The kind of tests that are selected.
- The order in which the tests are selected.
- The number of points measured in a test. (This is determined by the start, stop, and step values in certain test parameters.)

Tests can be selected in any order; but to reduce testing time, you should strategically organize the test sequence. Tests requiring operator intervention (changing volume, channels, and so forth) should be grouped together.

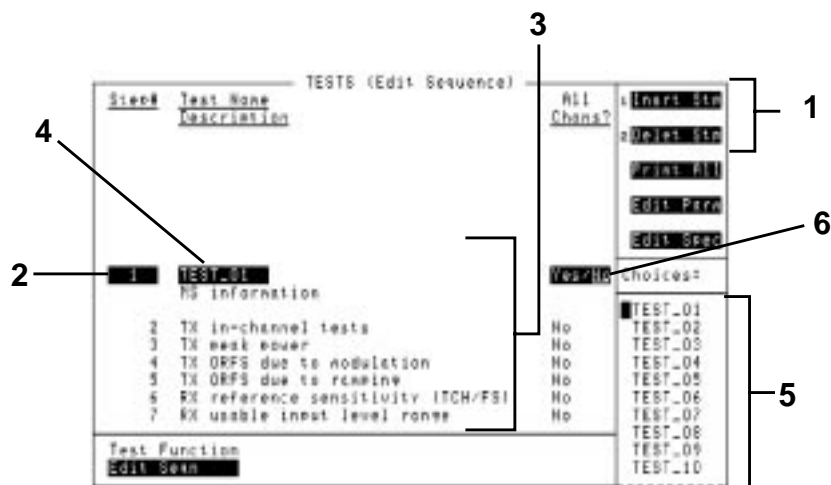

Figure 8-14 Test-Sequence Screen

Editing Test Specifications

Test Specifications are the upper and lower limit values that are used by the Test Executive to describe the manufactured specifications of the radio itself. For a radio to pass a test, the measured value must fall within the test's specified value (lower limit, upper limit, or both upper and lower limits).

- 1 **TESTS** and select the field **Test Function** at the bottom of the screen.
- 2 From the list of **Choices** in the revealed box, select **Edit Seqn** and edit the

Instrument BASIC
 Programming and Using the TESTS Subsystem

Test Sequence as described below.

- 3 When finished editing sequence select **TESTS** to return to test screen.
 - a. Select either **Edit Parm** or **Edit Spec** from the test function field to continue editing.
 - OR
 - b. If editing is complete, select **TESTS** and press **L2** or select **Continue** to return to the **Edit Proc** screen, then press **L1** or select **Run** to run the modified test procedure.

To add tests, select the following keys according to the labelled steps in Figure 8-15 on page 8-34:

- 1 Press **L1** or select **Insrt Stp** to insert a step.
- 2 Select the test name (example TEST_09) to modify the inserted step.
- 3 Select a new Test name for the inserted step.
- 4 Press **L2** or select **Delet Stp** to remove steps from a procedure.

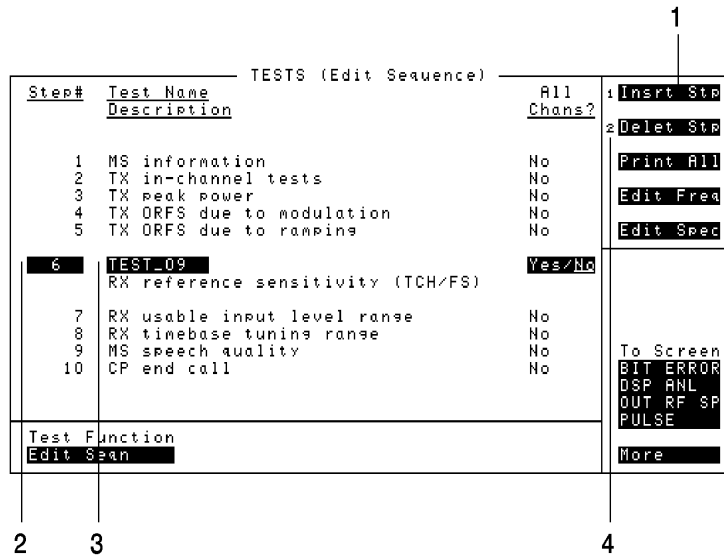

Figure 8-15 Edit Sequence Screen on the HP/Agilent 83212X

NOTE The tests you select determine the specifications that are required.

Editing Test Parameters

From the Edit Procedure screen (see Procedure Development section in this chapter), select the following keys:

- 1 **TESTS** and select the field **Test Function** at the bottom of the screen.
- 2 From the list of **Choices** in the revealed box, select **Edit Parm** and edit the Test Parameters as described below.
- 3 When finished editing parameters select **TESTS** to return to test screen.
 - a. Select either **Edit Seqn** or **Edit Spec** from the test function field to continue editing.
 - OR
 - b. If editing is complete, select **TESTS** and press **L2** or select **Continue** to return to the **Edit Proc** screen, then press **L1** or select **Run** to run the modified test procedure.

NOTE For a fuller explanation of the fields see Edit Parameter.

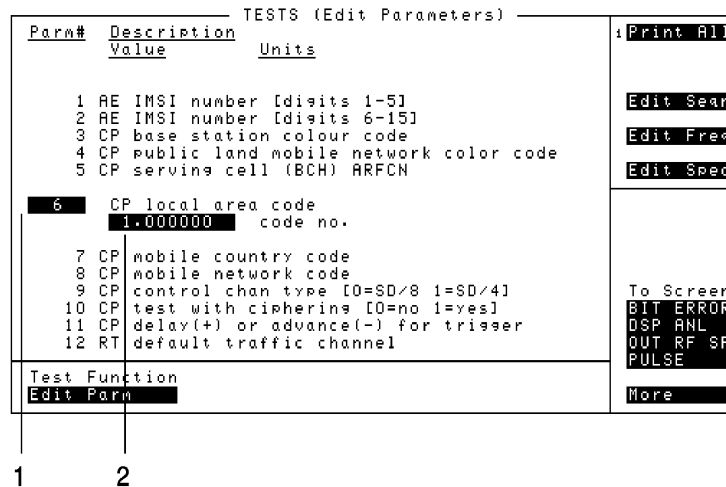

Figure 8-16 Edit Parameters Screen on the HP/Agilent 83212X

Select the following information according to the labelled steps in Figure 8-16 on page 8-35:

- 1 Select the parameter to modify, either by scrolling with the knob or entering the Parameter Number with the Data Keypad.
- 2 Select the Description Value and enter a new parameter value.

Configuring External Instruments for GPIB Control

Use the following instructions to configure the IBASIC computer to see external instruments on the GPIB “700” bus.

Instrument BASIC

Programming and Using the TESTS Subsystem

- 1 Select the front-panel **TESTS** key, and then the **Test Function Edit Cnfg.** A configuration screen similar to that shown in Figure 8-17 on page 8-37 appears.
- 2 Select the **Calling Name** field and enter the instrument's name in upper-case letters. For example, **PRINTER, POWER SUPPLY, DATA COLLECTION**, and so forth. Refer to item (1) in Figure 8-17 on page 8-37.
- 3 Select the **Model** field and enter the instrument's model number. There is no specific syntax for entering model numbers into this field. Refer to item (2) in Figure 8-17 on page 8-37.
- 4 Select the **Addr** (address) field and turn the knob to enter the last two digits of the instrument's GPIB address. Refer to item (3) in Figure 8-17 on page 8-37. (The RS-232 address must be 9, and the Data Collection address must be 1.)
- 5 Select the **Options** field (refer to item (4) in Figure 8-17 on page 8-37) and enter the instrument's option number(s) if any. This field may be left blank, or otherwise may include other calling name options, for example:

Printer options – **LN=#, START, END**

Where **#** is the number of lines on each page.

Where **START** causes a form feed at the start of each printout.

Where **END** causes a form feed at the end of each printout.

Data collection option – **NN**

Where **NN** is the number of records (file size) for the mass-storage location where data will be collected on disk or memory card. The default record size is "80".

- 6 Press the **Insrt Ins** field or **Delet Ins** field as needed or turn the knob to insert or delete as many instruments as needed. Refer to item (5) in Figure 8-17 on page 8-37.

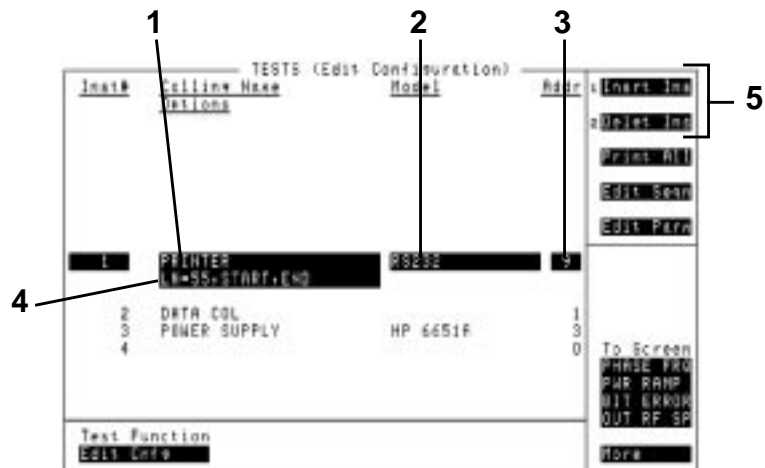

Figure 8-17 Instrument-Configuration Screen

Program Structure for TESTS Subsystem Programs

Writing programs that take advantage of the TESTS subsystem capabilities requires the programmer to understand how to structure the program to access the TESTS subsystem user-interface screens.

General Organization

Here are the steps to a basic algorithm that can be used to execute a number of test subroutines at a number of different frequencies:

- BEGIN
- SET UP (Set up the COM area to hold the global variables.)
- REPEAT (for all Defined Tests)
 - DO SUBROUTINE (defined Test)
- UNTIL (All Defined Tests Done)
- END
- SUBROUTINE1 (Defined Test 1)
- SUBROUTINE2 (Defined Test 2)
- SUBROUTINE3 (Defined Test 3)

Instrument BASIC

Programming and Using the TESTS Subsystem

Program Example

The following example IBASIC program uses the basic algorithm shown above and the TESTS subsystem to execute a number of test subroutines at a number of defined test frequencies. Also included are examples of how to interact with the user-interface to allow a user to access parameters, specifications, and configuration fields to define a specific set of test requirements.

An explanation of the program example is given at the end of the listing.

Program Listing

```
10      ! DEMO_1
20      !
30      ! THE FIRST LINE MUST CONTAIN THE NAME OF THE LIBRARY
40      !
50      ! _____
60      !
70      ! THIS PROGRAM IS A DEMO PROGRAM TO DEMONSTRATE THE USE
80      ! OF THE TEST SUBSYSTEM ON THE Agilent 8922M
90      !
100     ! REVISION: 1 APRIL, 1991
110     !
120     ! _____
130     COM /I_o/ I_o${470}
140     ! INPUT OUTPUT STRING
150     COM /Freq/ Rx_f,Tx_f
160     ! PRESENT RX AND TX FREQUENCIES IN MHZ
170     !
180     INTEGER Test_return
190     ! TITLE SCREEN FOR OUR TESTS
200     CLEAR SCREEN
210     PRINT TABXY(2,2),"___DEMO PROGRAM FOR THE TESTS SUBSYSTEM___"
220     !
230     ! SET UP A SOFT KEY TO HALT THE PROGRAM
240     ON KEY 1 LABEL "Stop Test",5 GOTO Stp_test
250     !
260     ! CLEAR THE INTERNAL HP 8922M BUS
270     CLEAR 800
280     !
290     ! NOW READ THE TEST FREQUENCIES IN ONE AT A TIME AND DO THE
300     ! SEQUENCE OF TESTS ON THEM
310     Ch=1
320     REPEAT
330         OUTPUT 800;"TESTS:FREQ? "&VAL$(Ch)
340         I_o$=""
350         ENTER 800;I_o$
360         !                               SET THE VALUE OF THE RX FREQUENCY
370         Rx_f=VAL(I_o${4;12})
380         !                               SET THE VALUE OF THE TX FREQUENCY
390         Tx_f=VAL(I_o${30;12})
400         !                               SET WHETHER TO TEST THIS FREQUENCY
410         T_it$=I_o${56;1}
420         !                               SET IF THIS IS A PRIME FREQUENCY
430         IF (LEN(I_o$)>57) THEN
440             Prime$=I_o${58;1}
450         ELSE
460             Prime$="N"
470         END IF
480         !                               IF THIS FREQUENCY IS TO BE TESTED
```

Instrument BASIC
Programming and Using the TESTS Subsystem

```

490 IF T_it$="Y" THEN
500 PRINT TABXY(2,6),"RX FREQUENCY = ",Rx_f
510 PRINT TABXY(2,7),"TX FREQUENCY = ",Tx_f
520 PRINT TABXY(2,8),"TEST THIS FREQUENCY ? ",T_it$
530 Run_ts=1
540 ! RUN THROUGH THE SEQUENCE OF TESTS
550 REPEAT
560 Done_t=0
570 ! ENTER IN THE TEST SEQUENCE
580 OUTPUT 800;"TESTS:SEQN? "&VAL$(Run_ts)
590 I_o$=""
600 ENTER 800;I_o$
610 Tst=VAL(I_o$[4;2])
620 ! IF THIS TEST IS TO BE SKIPPED THEN SET THIS
630 IF I_o$[7;1]="N" THEN Tst=-Tst
640 ! IF THIS IS A PRIME FREQUENCY RUN THE TEST
650 IF Tst&%<0 AND Prime$="Y" THEN
660 ! CALLS THE SUBROUTINE NAME T(ABS(Tst))
670 T(ABS(Tst),Test_return)
680 IF (Test_return=1) THEN GOTO Test_error
690 Done_t=1
700 END IF
710 ! IF THIS TEST IS TO BE DONE AND IS NOT A PRIME FREQUENCY
720 IF Tst>0 AND NOT Done_t THEN
730 ! CALLS THE SUBROUTINE NAME T(ABS(Tst))
740 T(ABS(Tst),Test_return)
750 IF (Test_return=1) THEN GOTO Test_error
760 END IF
770 Run_ts=Run_ts+1
780 UNTIL Tst=0 OR Run_ts=51
790 END IF
800 Ch=Ch+1
810 UNTIL Ch=51 OR Tx_f=-1 OR Rx_f=-1
820 Stp_test: !
830 CLEAR SCREEN
840 PRINT TABXY(2,10),"FINISHED TESTING"
850 GOTO End_program
860 Test_error: !
870 CLEAR SCREEN
880 PRINT TABXY(2,10),"PROGRAM STOPPED, TEST ",ABS(Tst),"FAILED"
890 End_program: !
900 END
910 T01:SUB T01(Test_return)
920 COM /I_o/ I_o$
930 COM /Freq/ Rx_f,Tx_f
940 DIM Calling_name${22},Model${22},Options${22}
950 ! TEST ROUTINE NUMBER 1
960 PRINT TABXY(2,12),"DOING TEST NUMBER 1 FOR FREQ ",Rx_f
970 ! GET THE PARAMETER 1 FOR THIS TEST
980 OUTPUT 800;"TESTS:PARM? "&VAL$(1)
990 I_o$=""
1000 ENTER 800;I_o$
1010 ! IF THERE IS NO PARAMETER THEN PAUSE
1020 IF I_o$[1;5]="Error" THEN
1030 PRINT TABXY(2,14),"ERROR IN RECALLING THE PARAMETERS FOR
TEST 1"
1040 Test_return=1
1050 END IF
1060 Parm_1=VAL(I_o$)
1070 ! GET CONFIGURATION 1 INFO FOR THIS TEST
1080 OUTPUT 800;"TESTS:CONF? "&VAL$(1)
1090 I_o$=""
1100 ENTER 800;I_o$

```

Instrument BASIC

Programming and Using the TESTS Subsystem

```
1110 Calling_name$=I_o${4;21]
1120 Model$=I_o${27;21]
1130 I_laddr=VAL(TRIM$(I_o${50}))
1140 Options$=I_o${54]
1150 ! GET SPECIFICATION 1 FOR THIS TEST
1160 OUTPUT 800;"TESTS:SPEC? "&VAL$(1)
1170 I_o$=""
1180 ENTER 800;I_o$
1190 IF I_o${1;5}="Error" THEN
1200 PRINT TABXY(2,14),"ERROR IN RECALLING THE SPECIFICATIONS FOR
TEST 1"
1210 Test_return=1
1220 END IF
1230 Lower_limit=VAL(TRIM$(I_o${4}))
1240 Upper_limit=VAL(TRIM$(I_o${17}))
1250 Test$=TRIM$(I_o${30])
1260 SUBEND
1270 T02:SUB T02(Test_return)
1280 COM /I_o/ I_o$
1290 COM /Freq/ Rx_f,Tx_f
1300 ! TEST ROUTINE NUMBER 2
1310 PRINT TABXY(2,13),"DOING TEST NUMBER 2 FOR FREQ ",Rx_f
1320 SUBEND
1330 T03:SUB T03(Test_return)
1340 COM /I_o/ I_o$
1350 COM /Freq/ Rx_f,Tx_f
1360 ! TEST ROUTINE NUMBER 3
1370 PRINT TABXY(2,14),"DOING TEST NUMBER 3 FOR FREQ ",Rx_f
1380 SUBEND
1390 T:SUB T(N,Test_return)
1400 ! CALL THE PASSED TEST NUMBER (N)
1410 SELECT N
1420 CASE 1
1430 T01(Test_return)
1440 CASE 2
1450 T02(Test_return)
1460 CASE 3
1470 T03(Test_return)
"
"
"
2380 CASE 49
2390 T49(Test_return)
2400 CASE 50
2410 T50(Test_return)
2420 END SELECT
2430 SUBEND
```

Program Listing Explanation

The following is line-by-line explanation of the commands shown in the previous program example. Each explanation is in the format;

Linenumber: Command Description

- 10: This first line must contain the name of the Library and the program. This is checked by the TESTS subsystem when loading the program.
- 130: Establish a common I_o\$ string for the ENTER statements.
- 150: Establish common Rx_f and Tx_f that can be used by the subprograms (tests).
- 180: The Integer Test_return is used by the subprograms to indicate the test ended with some error condition. The meaning of Test_return could be expanded to include the status of the test (i.e. PASS/FAIL).
- 200: Clears the IBASIC Screen.
- 210: Prints and indication that the Demo program is running.
- 240: Allows the User to stop the program using a softkey.
- 270: Clear the Internal Bus of the Agilent 8922M/S
- 310: Ch keeps track of which channel we are currently testing.
- 320: Now Repeat for all Frequencies:
- 330: Request all the channel values from the Agilent 8922M/S.
- 340: I_o\$ gets the string return.
- 370: The Rx frequency is pulled from the string.
- 390: The Tx frequency is pulled from the string.
- 410: T_it\$ gets either a "Y" or an "N" depending on whether this frequency is to be tested.
- 430: If a Prime channel has been specified then Prime\$ gets a value of "Y".
- 490: If this frequency is to be tested:
- 500-520: Print out some information on the test about to be performed.
- 530: Run_ts holds the value of the test currently being run.
- 550: Repeat for all Specified Tests:
- 560: Done_t is initialized to not completed.
- 580: Get the Test specifier for the current Test.

Instrument BASIC
Programming and Using the TESTS Subsystem

590: Initialize I_o\$ to a null string.

600: I_o\$ holds the value of the return string.

610: Tst now hold the value of the current test. This value is equal to the index of the Test Name in the Test selection list shown on the Test Seqn screen.

630: This tests whether this test is to be run for all channels. If not, the value is still kept around but is made negative. This will be used in later tests.

650: If the number of the test is indeed negative but the channel is prime, then the test is done.

670: This calls a subroutine that maps the number of the test with the subroutine that defines this test.

680: If there is an error, then the program stops and the error is reported.

690: Done_t is set to completed.

700: End this IF statement.

720: If Tst is suppose to be done, and has not yet been done, then now do it.

740: Again, This calls a subroutine that maps the number of the test with the subroutine that defines this test.

750: If there is an error, then the program stops and the error is reported.

760: End this IF statement.

770: Increment the step for the Test index.

780: If there are no more steps specified, or if the number of tests run is 51, then leave the test seqn loop.

790: End the Tst IF statement.

800: Increment the Channel number.

810: Stop stepping through the channels if the number of channels reaches 51, or if the Receive or Transmit frequencies are specified at -1.

820: The goto location for the stop test softkey.

830: Clear the screen

840: Indicate that the test is finished.

850: Goto the end statement.

860: The goto location if an error occurs in one of the subroutines.

870: Clear the screen.

880: Indicate that one of the tests have failed.

890: The goto for the end of the program.

900: End of the main program.

910: Subroutine T01-This corresponds with test #1. This subroutine illustrates how to enter values from the Parameters, Configuration, and Specification screens.

920-930: Includes the common variables.

940: Dimension some variables that will be used to store values from the configure screen.

960: Indicate that the first test is now active.

980: Enter the value of the first Parameter. This is the value of the first parameter on the Parameter Screen.

990: Initialize the I_o\$ string.

1000: Enter the value.

1020-1050: If there is no defined parameter this string will catch the error and return it to the main program.

1080: Get the information for the first instrument stored on the configure screen.

1090: Initialize the I_o\$ string.

1100: Enter the string.

1110: Calling_name\$ now holds the string associated with the Calling Name field on the configure screen.

1120: Model\$ now holds the string associated with the Model field on the configure screen.

1130: I1addr equals the value in the Addr field on the configure screen.

1140: Options\$ now holds the string associated with the Options field on the configure screen.

1160: Get the information for the first Specification listed on the Specification system.

1170: Initialize the I_o\$ string to null.

1180: ENTER the I_o\$ string.

1190-1220: If there is no specification defined for this specification number, then an Error will appear in the I_o\$ string. If this occurs, stop the test and return the error to the main program.

Instrument BASIC

Programming and Using the TESTS Subsystem

1230: Set the lower limit from the value in the string.

1240: Set the upper limit from the value in the string.

1250: Set Test\$ to whether “Upper”, “Lower”, “Both”, or “None” of the specs are to be tested.

1260: End of this subroutine.

1270-1380: These are the second and third subroutines. They are labeled T02 and T03 to correspond with the second and third test routines defined on the Test Seqn screen.

1390-2430: SUB T maps the calls from the main program to the correct subroutine. The mapping is quite simple, with the main program specifying which test to run and this subroutine calling the correct subroutine based on the SELECT statement.

Creating A Library And Default Procedure File

Once the Code file has been created, an associated Library and default Procedure file for the Code file can also be created.

Creating A Procedure File With No Library

If you do not want your program to use the different user-interface screens of the TESTS subsystem, you can create a Procedure from your Code file that does not have a Library associated with it. When the test information is defined, [NO LIB] is selected for the Library Name.

When creating a procedure to run without a Library, the first line of your Code file must be an exclamation point followed by the Code file name. For example, if your procedure is called 'FM_TESTS' the first line of your Code file **must** be

```
1    ! FM_TESTS
```

A

APPENDIX A

APPENDIX A

Purpose

Purpose

NOTE

This feature is not available on the Agilent 8922S.

Protocol Logging captures protocol messages to and from the mobile station in buffers in the Agilent 8922M. Messages can then be sent to an external Protocol Logger, such as the HP/Agilent 37900D, through the Protocol Interface connector on the rear panel.

WARNING

Before proceeding, you must consult the relevant User's Guides for all Safety Considerations that are to be observed while using this equipment.

Equipment Required

- HP/Agilent 37900D (Latest Revision).
- HP/Agilent 37967A HP/Agilent 8922G protocol monitor application software.¹
- HP/Agilent 37966B GSM software.
- HP/Agilent 15756A Interface Cable.
- HP/Agilent 37910A Slave Signalling Card.
- HP/Agilent 37913A RS232/449 Datacomms Interface Card.
- Agilent 8922M Option 003.

1. All software should be loaded into the HP/Agilent 37900D.

APPENDIX A

Connecting the Agilent 8922M to the HP/Agilent 37900D

Connecting the Agilent 8922M to the HP/Agilent 37900D

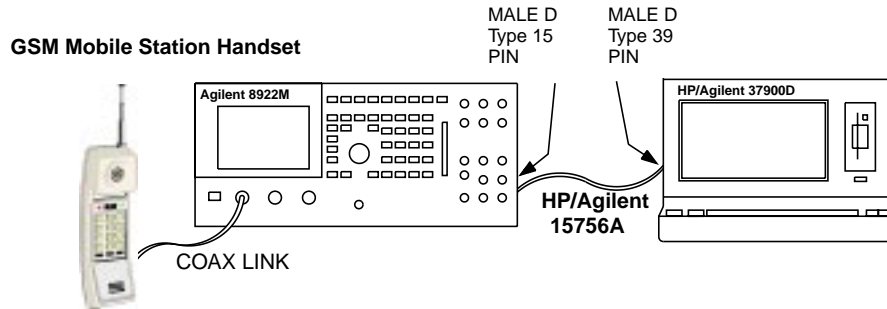

Figure A-1 Cabling Setup - Front View

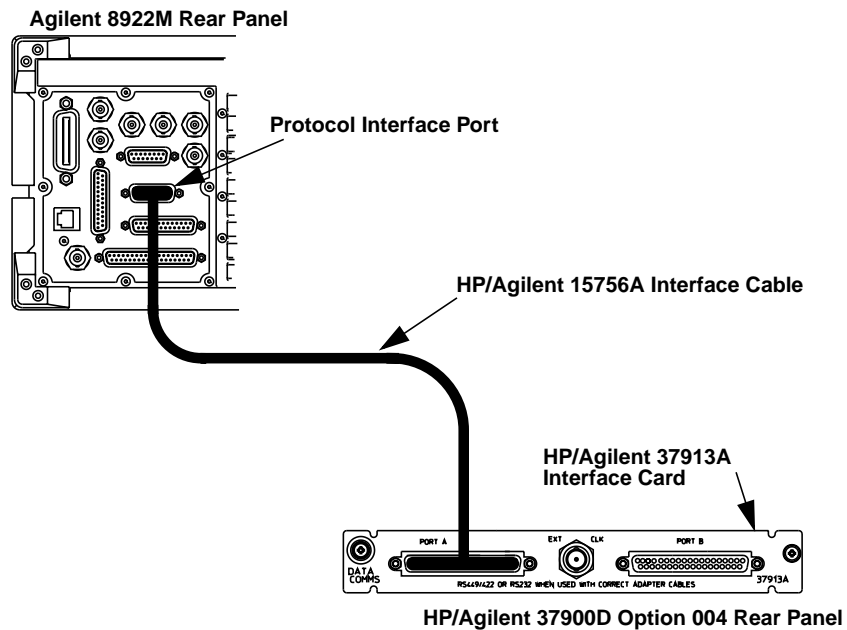

Figure A-2 Cabling Setup - Rear View

Using HP/Agilent 15756A Interface cable, connect PORT A on the rear of the HP/Agilent 37900D to the Protocol Interface Port on the rear panel of the Agilent 8922M.

Setting Up the Agilent Technologies 8922M

Camp On

Firstly, the Mobile Station should be "camped" on to the Agilent 8922M. That is the MCC, MNC, LAC should all be correct, and any adjustments to power level made as appropriate to the Mobile under test.

For more details on how to get "camped" on refer to "Making a Call From the Agilent 8922M/S to the Mobile Phone", Chapter 2, *Agilent 8922M/S GSM Test Set User's Guide*.

Set up Logging Screen

Set up the logging conditions to the Protocol Port using the logging screen. The logging screen gives you control over the Protocol Interface port on the rear panel. The screen is selected by highlighting **More** and selecting **LOGGING**. Then from highlighting the field below **Pass Filter**, one of the following logging conditions are available;

- a) NetwkOnly
- b) +DataLink
- c) +Service

For a full explanation of these options refer to "Additional Information", page A-11.

Set Service Latch

To enable protocol logging, the correct service latch must be set.

To set the correct service latch from the **Cell Control** screen select **CONFIG**. Then select **SERVICE** and then **Latch**. From this field choose **g_log_configuration** and ensure the **Value** is set to **0**.

Return to the Logging Screen.

Setting Up the HP/Agilent 37900D

Check Software Ensure that HP/Agilent 37966B and HP/Agilent 37967A software has been installed into the HP/Agilent 37900D. This software enables the HP/Agilent 37900D to communicate with the Agilent 8922M.

Set Personality From the HP/Agilent 37900D start-up screen highlight **PERSONALITY** and select **t**. This will display a submenu of personality options. Select **t** until **8922G** is highlighted then hit **Return**.

| | | | |
|-------------|--------------|-------------|------|
| PERSONALITY | APPLICATIONS | MANUAL MODE | HELP |
|-------------|--------------|-------------|------|

NOTE

It is acceptable to select **8922G** from the HP/Agilent 37900D. This option is a drop-in replacement for **8922M**.

Set Up Interface Card Ensure that the HP/Agilent 37913A Interface Card is set up correctly. Refer to the list below for **Port A** setting requirements;

Table 1

| | Port A Settings |
|-------------------|----------------------|
| Interface | RS-449/442 |
| Connection Setup | MONITOR |
| DCE/DTE | DCE |
| Clock Source | I'FACE HIGH |
| TxD Timing Source | TX CLOCK DTE SOURCED |
| Mark Polarity | NORMAL |

From the HP/Agilent 37900D start-up screen highlight **MANUAL MODE**. Select **t** until **CONFIGURATION** is highlighted then hit **Return**.

| | | | |
|-------------|--------------|-------------|------|
| PERSONALITY | APPLICATIONS | MANUAL MODE | HELP |
|-------------|--------------|-------------|------|

Then from the **CONFIGURATION MODE** menu, press 'M' and select the slot to be modified.

Set up the parameters for Port A as shown below

```

                                RS-449/422, RS-232
SLP
Slot   Card
3 RS449/422,RS232
2 Slave Signal
1
0

Port A                               Port B
-----+-----+-----+-----+-----+-----+-----+-----+
| RS449 DCE  I'FACE HIGH  M | RS232 DTE  I'FACE HIGH  M |
| No Card                                         | No Card                                         |
| No Card                                         | No Card                                         |
+-----+-----+-----+-----+-----+-----+

                                {{CURRENT SETTING}}
I - Interface                       >> RS-449/442           >> RS-449/442
S * connection Setup                >> MONITOR              >> MONITOR
D - DCE/DTE                          >> DCE                  >> DTE
C - Clock source                     >> I/FACE HIGH          >> I/FACE HIGH
T - TXD Timing source                >> TX CLOCK DTE SOURCED >> TX CLOCK DCE SOURCED
P - mark Polarity                    >> NORMAL               >> NORMAL

O - modify Other port                A - Auto-configure other port    Q - Quit

Enter menu option:

```

For Example, to change the Interface Setting;

Press 'I'

A new menu is shown listing the available options. When you have selected the required option, you are returned to the above menu.

Select Quit ('Q' from keyboard) twice.

Select Yes ('Y' from keyboard) to return to start-up screen.

Refer to the *HP/Agilent 37900D Monitor Guide* for detailed information on using the HP/Agilent 37900D Signaling Test Set.

How to Obtain a Protocol Log

NOTE

Protocol units are stored in a buffer in the Agilent 8922M until a certain number (~100) has been accumulated, and then they are sent out to the interface in a block. This means that it is not possible to have time stamps attached to the messages by the HP/Agilent 37900D.

NOTE

Also, even though there is nothing happening on the HP/Agilent 37900D, the Agilent 8922M and Mobile Station may still be active, with Agilent 8922M accumulating protocol messages to send to the HP/Agilent 37900D. With a call up, this occurs about every 15 seconds.

NOTE

The Agilent 8922M Option 003 occasionally send ABORTS to the attached protocol monitor. These ABORTS are normal and logging data is not lost. The ABORTS will normally only appear on the "Display Logged Data" screen of the HP/Agilent 37900D.

Check connection

Before logging can begin it is important to ensure that connection has been made.

With the HP/Agilent 37900D on the main Signaling Test Set (STS) screen, highlight **MANUAL MODE** and using the **t/s** key, select **MONITOR** to get to the **MONITOR MODE** menu.

Set the instrument to monitor the link by pressing 'M' which then takes you to the **MONITOR SIGNALLING LINKS** menu.

Press 1 to get a more detailed look at link 1 on the **MONITOR ISDN SIGNALLING LINK 1** screen. This is the link to which the cable from the Agilent 8922M is attached. If the link is good, then the Signalling Bit Rate under Channel 1 should be shown as 64000 Hz.

If Connection not working

If 0 Hz appears under Channel 1 then there is a fault. Check the following and if the signalling bit rate still does not change contact your local Agilent Technologies Sales and Service Office for assistance.

- 1 Check all cable connections.
- 2 Check Service Latch on the Agilent 8922M.
- 3 Check Interface Card setup in the HP/Agilent 37900D.

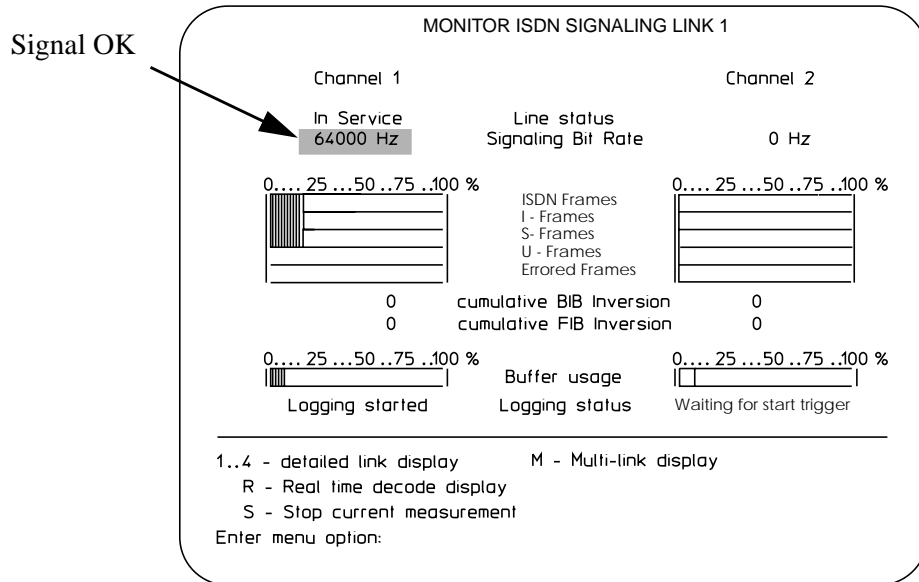

Agilent 8922M To log protocol messages into the Agilent 8922M

Logging Start-up

- 1 Select **Log/Pause**
- 2 Select **Clear Log**
- 3 Select **Log/Pause**

Make Call

With the real time display enabled (To see the messages themselves on the HP/Agilent 37900D, Press 'R' to get a real time display of incoming messages. These are short summaries of each message. To return to the MONITOR ISDN SIGNALLING LINK1 screen, select '1'), press '123' on the Mobile Station handset keypad, and press 'SEND', just as you would when making a real call on a GSM cellular phone. As the call comes up, there will be assignment appearing on the display of the HP/Agilent 37900D.

Real Time Message Display

To see the messages themselves on the HP/Agilent 37900D, press 'R' to get a real time display of incoming messages. These are short summaries of each message. To return to the **MONITOR ISDN SIGNALLING LINK1** screen, select '1'

Occasionally the bar graph indicators will rise up to 100% and then fall back as the Agilent 8922M empties its cache of messages. This only occurs when a call has been established.

APPENDIX A

How to Obtain a Protocol Log

- System Information sent and received** Once the call is up, then System Information messages will begin to appear for the entire duration of the call. Since there is only one 'BTS' there will be no handovers during the call. The System Information messages contain power measurements and bit error indications for both uplink and downlink directions.
- End Call** To end the call, on the Mobile Station handset, press 'END'. At this point the call will drop. There may not have been enough messages on the Agilent 8922M to fill the cache for the last messages to be put out to the HP/Agilent 37900D.
- Flush Log** To see the last protocol messages from the Mobile Station handset, go to the logging screen on the Agilent 8922M.
- Select **Flush Log**
- Press 'S' on the HP/Agilent 37900D to stop logging, and Quit (Press 'Q') to get back to the **MONITOR MODE** menu.
- Refer to the *HP/Agilent 37900D Monitor Guide* for detailed information on using the HP/Agilent 37900D Signaling Test Set.

Additional Information

Logging Screen

The logging screen gives you control over the Protocol Interface port on the rear panel (option 003). This function is selected by highlighting **More** and selecting **LOGGING**.



No protocol logging messages appear on the Agilent 8922M Logging screen.

- 1. Clear Log** Clear erases the contents of the logging buffers.
- 2. Flush Log** Flush Log transfers messages from partially full buffers to an external Protocol Logger through the Protocol Interface connector (rear panel).
When buffers are full, they are automatically flushed. Messages continue to be logged-in during Flush Log.
- 3. Log/Pause** Log will activate accumulation, or “logging” of protocol messages into dual circular logging buffers in the Agilent 8922M. Although the messages are delayed, the original sequence is maintained.
Pause will suspend logging.

APPENDIX A

Additional Information

- 4. Pass Filter** The Pass Filter allows you to select only the category of protocol messages you want logged into the Agilent 8922M internal logging buffers.

Choices

- **NetwkOnly** will pass these messages:

- peer-to-peer messages between the network layers (signaling layer 3).

Network peer-to-peer messages are only passed out through the interface. That is, only DL_UNIT_DATA and DL_DATA messages are passed out as they carry the L3 Network peer-to-peer messages. This includes all PTP messages between CC-CC, MM-MM and RR-RR.

- **+Datalink** will pass these messages:

- peer-to-peer messages between the network layers
- peer-to-peer messages between the data link layers.

This includes 'NetwrkOnly' plus Datalink peer-to-peer messages. That is, only DL_UNIT_DATA, DL_DATA and PH_DATA messages are passed out as they carry the L3 peer-to-peer and L2 peer-to-peer messages.

- **+Service** will pass these messages as (defined by GSM recommendations):

- peer-to-peer messages between the network layers
- peer-to-peer messages between data link layers
- intra-layer/inter-layer service request and response messages.
- Service primitives exchanged between the signaling layer of the Agilent 8922M.

This includes 'NetwrkOnly' plus 'DataLink' and all interlayer messages defined by GSM recommendations. It does not include HP proprietary messages.

Remote Control of Protocol Logging

It is possible to control the logging functions of the Agilent 8922M over the GPIB interface. For more details on how to do this refer to the *Agilent 8922M/S GSM Test Set Programming Reference Guide*.

Protocol Log of a Typical Call

For brevity, the protocol log shown in the User's Guide is in a shorter form than that presented by the HP/Agilent 37900D GSM 04.08 decoding option.

This is a protocol log of the Common Air Interface (CAI) for a typical call placed between the Agilent 8922M/S and a GSM Mobile Station. You are expected to be familiar with ETSI standards GSM 04.06 and 04.08 to understand these protocol logs. The logs are in a simplified format and contain the following information:

- Source Layer -> Destination Layer,
- PRIMITIVE,
- Logical Channel (if any),
- Data Link Frame Header,
- Layer 3 Message Type,
- Layer 3 Message Contents in hexadecimal,
- TDMA Frame number.

The Service Access Points (SAP) in the BS (Agilent 8922M/S) that are recorded are:

- Between CC and MM,
- Between MM and RR,
- Between RR and DL,
- Between DL and PH.

The call is BS originated to a class II MS. Authentication and encryption are not used. The initial TCH is full rate on ARFCN 30 using timeslot 4. The intra-cell handover is to a hopping TCH using ARFCN 10, 62 and 114 with MAIO set to zero using timeslot 6. The inter-cell handover is back to the ARFCN 30 timeslot 4 TCH. The call is BS terminated. The BCCH/CCCH is using SD/4 organization on ARFCN 20. Paging mode is normal and DTX is off. Requested MS transmit level is 15. This is an early assignment call without use of start times. The MS in this case is using DL I frames for acknowledgement rather than 'piggybacking' acknowledgement on following DL I frames. This is a Phase I MS and therefore only BM0 format BA, CA and MA tables are used.

Uplink traffic is in **bold** typeface, downlink traffic is in normal typeface.

APPENDIX A
Protocol Log of a Typical Call

**Base originated call
To TCH1 non-
hopped, ARFCN 30
Timeslot 4, SD/4
organization**

HST->CC CC_SETUP_REQ Frame 2446544
CC->MM MM_ESTABLISH Frame 2446544
MM->RR RR_EST Frame 2446544
RR->DL DL_UNIT_DATA PCH RR Paging Request Type 1 06 21 03 08 09 10
10 76 98 10 32 54 Frame 2446544
DL->PH PH_DATA PCH L2 ABIS M0 RR Paging Request Type 1 Frame
2446544
PH->DL PH_RANDOM_ACCESS RACH Frame 2446643
DL->RR DL_RANDOM_ACCESS RACH Frame 2446643
RR->DL DL_UNIT_DATA AGCH RR Immediate Assignment 06 3f 03 20 a0
14 92 aa 2e 00 00 Frame 2446653
DL->PH PH_DATA AGCH L2 ABIS M0 RR Immediate Assignment Frame
2446653

**Agilent 8922M/S
configures to DCH**

PH->DL PH_CONNECT SDCCH Frame 2446654
PH->DL PH_CONNECT SACCH Frame 2446654
PH->DL READY_TO_SEND SDCCH Frame 2446694
DL->PH PH_DATA SDCCH UI P0 CR1 SAPI0 M0 Frame 2446694
PH->DL READY_TO_SEND SACCH Frame 2446714
DL->PH PH_DATA SACCH UI P0 CR1 SAPI0 M0 Frame 2446714
**PH->DL PH_DATA SDCCH SABM P1 CR0 SAPI0 M0 RR Paging Re-
sponse Frame 2446718**
**DL->RR DL_ESTABLISH SDCCH RR Paging Response 06 27 04 03 01 00
00 08 09 10 10 76 98 10 32 54 Frame 2446718**
**RR->MM RR_EST RR Paging Response 06 27 04 03 01 00 00 08 09 10 10 76
98 10 32 54 Frame 2446718**
MM->CC MM_ESTABLISH Frame 2446718
CC->MM MM_DATA CC Setup 03 05 04 01 a0 34 3f Frame 2446718
MM->RR RR_DATA CC Setup 03 05 04 01 a0 34 3f Frame 2446718
RR->DL DL_DATA SDCCH CC Setup 03 05 04 01 a0 34 3f Frame 2446719
PH->DL PH_DATA SACCH UI P0 CR0 SAPI0 M0 RR Measurement Re-

port Frame 2446738

**DL->RR DL_UNIT_DATA SACCH RR Measurement Report 06 15 37 77
00 00 00 00 00 00 00 00 00 00 00 00 00 00 00 00 Frame 2446738**

PH->DL READY_TO_SEND SDCCH Frame 2446745

DL->PH PH_DATA SDCCH UA F1 CR0 SAPI0 M0 RR Paging Response
Frame 2446745

PH->DL PH_DATA SDCCH UI P0 CR0 SAPI0 M0 Frame 2446769

RR->DL DL_UNIT_DATA SACCH RR System Information Type 6 06 1e 00 01
00 f1 10 00 01 63 ff Frame 2446775

PH->DL READY_TO_SEND SDCCH Frame 2446796

DL->PH PH_DATA SDCCH I Nr0 Ns0 P0 CR1 SAPI0 M0 CC Setup Frame
2446796

PH->DL READY_TO_SEND SACCH Frame 2446816

DL->PH PH_DATA SACCH UI P0 CR1 SAPI0 M0 RR System Information
Type 6 Frame 2446816

PH->DL PH_DATA SDCCH RR Nr1 PF0 CR1 SAPI0 M0 Frame 2446820

**PH->DL PH_DATA SACCH UI P0 CR0 SAPI0 M0 RR Measurement Re-
port Frame 2446840**

**DL->RR DL_UNIT_DATA SACCH RR Measurement Report 06 15 37 37
00 00 00 00 00 00 00 00 00 00 00 00 00 00 00 00 Frame 2446840**

PH->DL READY_TO_SEND SDCCH Frame 2446847

DL->PH PH_DATA SDCCH UI P0 CR1 SAPI0 M0 Frame 2446847

**PH->DL PH_DATA SDCCH I Nr1 Ns0 P0 CR0 SAPI0 M0 CC Call Con-
firmed Frame 2446871**

DL->RR DL_DATA SDCCH CC Call Confirmed 83 08 Frame 2446871

RR->MM RR_DATA CC Call Confirmed 83 08 Frame 2446871

RR->DL DL_UNIT_DATA SACCH RR System Information Type 5 06 1d 00
00 00 00 00 00 00 00 00 00 00 00 00 08 00 00 Frame 2446875

MM->CC MM_DATA CC Call Confirmed 83 08 Frame 2446875

CC->CC CC_SYNC Frame 2446875

CC->MM MM_SYNC Frame 2446875

APPENDIX A

Protocol Log of a Typical Call

Agilent 8922M/S
Configures to TCH

MM->RR RR_SYNC Frame 2446875
RR->DL DL_DATA SDCCH RR Assignment Command 06 2e 0c a0 1e 0f 63 01
Frame 2446875
PH->DL READY_TO_SEND SDCCH Frame 2446898
DL->PH PH_DATA SDCCH I Nr1 Ns1 P0 CR1 SAPI0 M0 RR Assignment
Command Frame 2446898
RR->DL DL_RELEASE SDCCH Frame 2446906
DL->RR DL_RELEASE SDCCH Frame 2446906
RR->DL DL_RELEASE SACCH Frame 2446906
DL->RR DL_RELEASE SACCH Frame 2446906

PH->DL PH_CONNECT FACCH_F Frame 2446911
PH->DL PH_CONNECT SACCH_TF Frame 2446911
PH->DL PH_DATA FACCH_F SABM P1 CR0 SAPI0 M0 Frame 2446923
DL->DL READY_TO_SEND FACCH_F Frame 2446923
DL->RR DL_ESTABLISH FACCH_F Frame 2446923
DL->PH PH_DATA FACCH_F UA F1 CR0 SAPI0 M0 Frame 2446923
PH->DL READY_TO_SEND FACCH_F Frame 2446926
**PH->DL PH_DATA FACCH_F I Nr0 Ns0 P0 CR0 SAPI0 M0 RR Assign-
ment Complete Frame 2446953**
DL->DL READY_TO_SEND FACCH_F Frame 2446953
**DL->RR DL_DATA FACCH_F RR Assignment Complete 06 29 00 Frame
2446953**
DL->PH PH_DATA FACCH_F RR Nr1 PF0 CR0 SAPI0 M0 Frame 2446954
PH->DL READY_TO_SEND FACCH_F Frame 2446960
PH->DL READY_TO_SEND SACCH Frame 2446974
DL->PH PH_DATA SACCH UI P0 CR1 SAPI0 M0 RR System Information
Type 5 Frame 2446974
RR->MM RR_SYNC Frame 2446974
MM->CC MM_SYNC Frame 2446975

**PH->DL PH_DATA FACCH_F I Nr0 Ns1 P0 CR0 SAPI0 M0 CC Alerting
Frame 2446988**

DL->DL READY_TO_SEND FACCH_F Frame 2446988

DL->RR DL_DATA FACCH_F CC Alerting 83 41 Frame 2446988

DL->PH PH_DATA FACCH_F RR Nr2 PF0 CR0 SAPI0 M0 Frame 2446988

RR->MM RR_DATA CC Alerting 83 41 Frame 2446989

MM->CC MM_DATA CC Alerting 83 41 Frame 2446989

CC->HST CC_ALERT Frame 2446989

PH->DL READY_TO_SEND FACCH_F Frame 2446995

RR->DL DL_UNIT_DATA SACCH_TF RR System Information Type 6 06 1e
00 01 00 f1 10 00 01 63 ff Frame 2447056

**PH->DL PH_DATA SACCH UI P0 CR0 SAPI0 M0 RR Measurement Re-
port Frame 2447058**

**DL->RR DL_UNIT_DATA SACCH RR Measurement Report 06 15 37 77
4e 00 00 00 00 00 00 00 00 00 00 00 00 00 00 00 Frame 2447058**

PH->DL READY_TO_SEND SACCH Frame 2447078

DL->PH PH_DATA SACCH_TF UI P0 CR1 SAPI0 M0 RR System Information
Type 6 Frame 2447078

**PH->DL PH_DATA FACCH_F I Nr0 Ns2 P0 CR0 SAPI0 M0 CC Connect
Frame 2447092**

DL->DL READY_TO_SEND FACCH_F Frame 2447092

DL->RR DL_DATA FACCH_F CC Connect 83 07 Frame 2447092

DL->PH PH_DATA FACCH_F RR Nr3 PF0 CR0 SAPI0 M0 Frame 2447092

RR->MM RR_DATA CC Connect 83 07 Frame 2447093

MM->CC MM_DATA CC Connect 83 07 Frame 2447093

CC->HST CC_SETUP_CONF Frame 2447093

CC->MM MM_DATA CC Connect Acknowledge 03 0f Frame 2447093

MM->RR RR_DATA CC Connect Acknowledge 03 0f Frame 2447093

RR->DL DL_DATA FACCH_F CC Connect Acknowledge 03 0f Frame
2447093

PH->DL READY_TO_SEND FACCH_F Frame 2447099

DL->DL READY_TO_SEND FACCH_F Frame 2447716
DL->RR DL_ESTABLISH FACCH_F Frame 2447717
DL->PH PH_DATA FACCH_F UA F1 CR0 SAPI0 M0 Frame 2447717
PH->DL READY_TO_SEND FACCH_F Frame 2447724
PH->DL READY_TO_SEND SACCH Frame 2447728
DL->PH PH_DATA SACCH_TF UI P0 CR1 SAPI0 M0 RR System Information
Type 6 Frame 2447728
**PH->DL PH_DATA FACCH_F I Nr0 Ns0 P0 CR0 SAPI0 M0 RR Assign-
ment Complete Frame 2447751**
DL->DL READY_TO_SEND FACCH_F Frame 2447752
**DL->RR DL_DATA FACCH_F RR Assignment Complete 06 29 00 Frame
2447752**
DL->PH PH_DATA FACCH_F RR Nr1 PF0 CR0 SAPI0 M0 Frame 2447752
PH->DL READY_TO_SEND FACCH_F Frame 2447759
RR->MM RR_SYNC Frame 2447772
MM->CC MM_SYNC Frame 2447773

Intra-cell handover is complete

**Inter-cell handover
to TCH1, Single
TCH on ARFCN 30,
slot 4**

HST->CC CC_SYNC Frame 2448955
CC->MM MM_SYNC Frame 2448955
MM->RR RR_SYNC Frame 2448955
RR->DL DL_DATA FACCH_F RR Handover Command 06 2b 0d 14 0c a0 1e
3b 0f d0 Frame 2448955
DL->DL READY_TO_SEND FACCH_F Frame 2448955
DL->PH PH_DATA FACCH_F I Nr1 Ns0 P0 CR1 SAPI0 M0 RR Handover
Command Frame 2448955
**PH->DL PH_DATA SACCH UI P0 CR0 SAPI0 M0 RR Measurement Re-
port Frame 2448957**
**DL->RR DL_UNIT_DATA SACCH RR Measurement Report 06 15 37 37
00 77 01 a0 00 00 00 00 00 00 00 00 00 00 00 00 00 00 00 00 Frame 2448957**
PH->DL READY_TO_SEND FACCH_F Frame 2448963

APPENDIX A
Protocol Log of a Typical Call

Agilent 8922M/S
configures to new
TCH

PH->DL READY_TO_SEND SACCH Frame 2448976

DL->PH PH_DATA SACCH_TF UI P0 CR1 SAPI0 M0 RR System Information
Type 6 Frame 2448976

RR->DL DL_RELEASE FACCH_F Frame 2448978

DL->RR DL_RELEASE FACCH_F Frame 2448978

RR->DL DL_RELEASE SACCH_TF Frame 2448978

DL->RR DL_RELEASE SACCH_TF Frame 2448978

PH->DL PH_CONNECT FACCH_F Frame 2448982

PH->DL PH_CONNECT SACCH_TF Frame 2448982

PH->DL MPH_ACCESS RACH Frame 2448987

DL->RR MDL_ACCESS RACH Frame 2448988

RR->DL DL_UNIT_DATA FACCH_F RR Physical Information 06 2d 00
Frame 2448988

DL->DL READY_TO_SEND FACCH_F Frame 2448988

DL->PH PH_DATA FACCH_F UI P0 CR1 SAPI0 M0 RR Physical Information
Frame 2448988

PH->DL READY_TO_SEND FACCH_F Frame 2448997

RR->DL DL_UNIT_DATA FACCH_F RR Physical Information 06 2d 00
Frame 2448998

DL->DL READY_TO_SEND FACCH_F Frame 2448998

DL->PH PH_DATA FACCH_F UI P0 CR1 SAPI0 M0 RR Physical Information
Frame 2448998

PH->DL READY_TO_SEND FACCH_F Frame 2449006

RR->DL DL_UNIT_DATA FACCH_F RR Physical Information 06 2d 00
Frame 2449009

DL->DL READY_TO_SEND FACCH_F Frame 2449009

DL->PH PH_DATA FACCH_F UI P0 CR1 SAPI0 M0 RR Physical Information
Frame 2449009

PH->DL READY_TO_SEND FACCH_F Frame 2449014

RR->DL DL_UNIT_DATA FACCH_F RR Physical Information 06 2d 00

Frame 2449020

DL->DL READY_TO_SEND FACCH_F Frame 2449020

DL->PH PH_DATA FACCH_F UI P0 CR1 SAPI0 M0 RR Physical Information
Frame 2449020

PH->DL READY_TO_SEND FACCH_F Frame 2449023

RR->DL DL_UNIT_DATA FACCH_F RR Physical Information 06 2d 00
Frame 2449030

DL->DL READY_TO_SEND FACCH_F Frame 2449031

DL->PH PH_DATA FACCH_F UI P0 CR1 SAPI0 M0 RR Physical Information
Frame 2449031

PH->DL READY_TO_SEND FACCH_F Frame 2449032

PH->DL PH_DATA FACCH_F SABM P1 CR0 SAPI0 M0 Frame 2449038

DL->DL READY_TO_SEND FACCH_F Frame 2449038

DL->RR DL_ESTABLISH FACCH_F Frame 2449038

DL->PH PH_DATA FACCH_F UA F1 CR0 SAPI0 M0 Frame 2449038

PH->DL READY_TO_SEND FACCH_F Frame 2449040

PH->DL READY_TO_SEND SACCH Frame 2449054

DL->PH PH_DATA SACCH UI P0 CR1 SAPI0 M0 Frame 2449054

RR->DL DL_UNIT_DATA SACCH_TF RR System Information Type 5 06 1d
00 00 00 00 00 00 00 00 00 00 00 00 00 00 08 00 00 Frame 2449058

**PH->DL PH_DATA FACCH_F I Nr0 Ns0 P0 CR0 SAPI0 M0 RR Handover
Complete Frame 2449068**

DL->DL READY_TO_SEND FACCH_F Frame 2449068

**DL->RR DL_DATA FACCH_F RR Handover Complete 06 2c 00 Frame
2449068**

DL->PH PH_DATA FACCH_F RR Nr1 PF0 CR0 SAPI0 M0 Frame 2449068

PH->DL READY_TO_SEND FACCH_F Frame 2449075

RR->MM RR_SYNC Frame 2449089

MM->CC MM_SYNC Frame 2449089

APPENDIX A
Protocol Log of a Typical Call

Inter-cell handover complete

Call termination

HST->CC CC_DISC Frame 2449729
CC->MM MM_DATA CC Disconnect 03 25 02 e0 90 Frame 2449729
MM->RR RR_DATA CC Disconnect 03 25 02 e0 90 Frame 2449729
RR->DL DL_DATA FACCH_F CC Disconnect 03 25 02 e0 90 Frame 2449729
DL->DL READY_TO_SEND FACCH_F Frame 2449729
DL->PH PH_DATA FACCH_F I Nr1 Ns0 P0 CR1 SAPI0 M0 CC Disconnect
Frame 2449729
PH->DL READY_TO_SEND FACCH_F Frame 2449734
RR->DL DL_UNIT_DATA SACCH_TF RR System Information Type 5 06 1d
00 00 00 00 00 00 00 00 00 00 00 00 00 00 08 00 00 Frame 2449760
**PH->DL PH_DATA FACCH_F RR Nr1 PF0 CR1 SAPI0 M0 Frame
2449761**
DL->DL READY_TO_SEND FACCH_F Frame 2449761
**PH->DL PH_DATA SACCH UI P0 CR0 SAPI0 M0 RR Measurement Re-
port Frame 2449762**
**DL->RR DL_UNIT_DATA SACCH RR Measurement Report 06 15 37 37
00 77 01 a0 00 00 00 00 00 00 00 00 00 00 00 00 Frame 2449762**
PH->DL READY_TO_SEND SACCH Frame 2449782
DL->PH PH_DATA SACCH_TF UI P0 CR1 SAPI0 M0 RR System Information
Type 5 Frame 2449782
**PH->DL PH_DATA FACCH_F I Nr1 Ns1 P0 CR0 SAPI0 M0 CC Release
Frame 2449800**
DL->DL READY_TO_SEND FACCH_F Frame 2449800
DL->RR DL_DATA FACCH_F CC Release 83 6d Frame 2449800
DL->PH PH_DATA FACCH_F RR Nr2 PF0 CR0 SAPI0 M0 Frame 2449800
RR->MM RR_DATA CC Release 83 6d Frame 2449801
MM->CC MM_DATA CC Release 83 6d Frame 2449801
CC->MM MM_DATA CC Release Complete 03 2a Frame 2449801
MM->RR RR_DATA CC Release Complete 03 2a Frame 2449801

RR->DL DL_DATA FACCH_F CC Release Complete 03 2a Frame 2449801
CC->MM MM_RELEASE Frame 2449801
MM->RR RR_REL Frame 2449801
RR->DL DL_DATA FACCH_F RR Channel Release 06 0d 00 Frame 2449801
RR->DL MDL_RELEASE SACCH_TF Frame 2449802
CC->HST CC_REL_IND Frame 2449802
PH->DL READY_TO_SEND FACCH_F Frame 2449803
DL->PH PH_DATA FACCH_F I Nr2 Ns1 P0 CR1 SAPI0 M0 CC Release Complete Frame 2449803
PH->DL READY_TO_SEND FACCH_F Frame 2449812
PH->DL PH_DATA FACCH_F RR Nr2 PF0 CR1 SAPI0 M0 Frame 2449839
DL->DL READY_TO_SEND FACCH_F Frame 2449839
DL->PH PH_DATA FACCH_F I Nr2 Ns2 P0 CR1 SAPI0 M0 RR Channel Release Frame 2449839
PH->DL READY_TO_SEND FACCH_F Frame 2449846
PH->DL PH_DATA SACCH UI P0 CR0 SAPI0 M0 RR Measurement Report Frame 2449866
PH->DL PH_DATA FACCH_F RR Nr3 PF0 CR1 SAPI0 M0 Frame 2449874
DL->DL READY_TO_SEND FACCH_F Frame 2449874
PH->DL READY_TO_SEND SACCH Frame 2449886
PH->DL PH_DATA FACCH_F DISC P1 CR0 SAPI0 M0 Frame 2449909
DL->DL READY_TO_SEND FACCH_F Frame 2449909
DL->PH PH_DATA FACCH_F UA F1 CR0 SAPI0 M0 Frame 2449909
PH->DL READY_TO_SEND FACCH_F Frame 2449916
DL->RR DL_RELEASE FACCH_F Frame 2449930

Call termination complete, HP 8922M/S configures to BCCH

APPENDIX A
Protocol Log of a Typical Call

B

Glossary

| | |
|-----------------------|--|
| ARFCN | Absolute Radio Frequency Channel Number |
| BCH | <p>The BCH (Broadcast Channel) is a beacon which is always turned on so that mobile can look out for it when trying to find service. A useful BCH always carries information in timeslot 0. The BCH ARFCN has to be active in all timeslots to allow mobiles to synchronize to other cells. There are a number of other areas to the BCH:</p> <ul style="list-style-type: none">• TCH (Frequency correction Channel) is a special burst on the BCH. It has special fixed bit sequences to allow the mobile to tune onto the midamble.• SCH (Synchronization Channel) has a burst with extended midamble. It is used by the mobile to adjust its internal timing and get synchronized to the multiframe sequence.• BCCH (Broadcast Control Channel) has information encoded on it which identifies the network. It also carries lists of the channels in use in the cell (BA and CA tables).• CCCH (Common Control Channel) is like a message board. Like the FCH, SCH, and BCCH, it can be received by any mobile. Sub-channels like PCH (Paging Channel) and AGCH (Access Grant Channel) are posted on the CCCH. |
| BCCH | Broadcast Control Channel. A unidirectional channel used by the base station facilities to broadcast control information to land mobile units. |
| Bit Error Rate | The digital receiver test that measures of the quality of the recovered information (sensitivity and usable input level range) equivalent to SINAD in an analog system. |
| BS | Base Station |
| BTS | Base Transceiver System |

| | |
|--------------------------------------|--|
| Burst-by-Burst Bit Error Rate | The Burst-by-Burst Bit Error Measurement makes use of a new loopback path within the mobile to calculate the equivalent Class II BER. This measurement is 5 times faster than the conventional method. This is also sometimes known as Fast Bit Error Measurement. |
| Channel Coding | The baseband digital process used to arrange the error protected speech data into the final form necessary for RF transmission. Channel coding involves adding the following data for channel control: training sequences, tail bits, and guard bits. |
| Class I Bits | In an error correction scheme, the most important data bits. This class is subdivided into classes Ia and Ib. |
| Class II Bits | In an error correction scheme, the slowly changing or long-term data bits. Class II bits receive no error correction. |
| CRC | Cyclic Redundancy Check. A method for detecting errors by dividing the reception polynomial (which expresses the reception data) by the generator polynomial, and then detecting errors by residuals. |
| DCS1800 | Digital Cellular System. DCS1800 is technically very similar to GSM900 with wider frequency bands leading to more channels and at a frequency of 1.8 GHz. DCS1800 systems are designed to cope with higher user densities. DCS1800 mobiles have a lower output power than GSM900 mobiles, therefore the cell size is smaller. |
| Equalization | The process used by digital radios to correct for the fading which occurs in real world conditions. |
| Error Correction | A way to provide reasonable voice quality for digital radios that are subject to Doppler shifts and multipath fading. Types of error correction include parity bits, cyclic error correction coding, and convolutional coding. |
| FACCH | When the SACCH reports coming back to the BS indicate that another cell would offer the mobile a better signal quality, a handover is necessary. The SACCH doesn't have the bandwidth necessary to transfer all the information associated with the handover. The TCH is replaced by a FACCH (Fast Associated Control Channel), for a short time using short consecutive bursts, which have a higher data rate than the SACCH, which |

Glossary

| | |
|---------------------------|--|
| | only uses one burst in 26. When the FACCH steals control from the TCH small drop-outs in the speech can often be heard. |
| Frame | A repetitive collection of time slots in a TDMA system. |
| GMSK | Gaussian Filtered Minimum Shift Keying. The type of digital modulation used for the GSM system. |
| GSM900 | Global System for Mobile Communication. GSM900 is the original GSM system, using frequencies in the 900 MHz band, and is designed for wide area cellular operation. |
| Global Phase Error | An in-channel test of modulation quality for GSM transmitters using a constant amplitude envelope when transmitting information. Global phase measures the difference between the measured phase trajectory and the ideal phase trajectory. |
| Guard Bits | These bits provide a buffer between adjacent data packets. There are ramp-up and ramp-down guard bits. |
| IMSI | International Mobile Subscriber Identification. A unique subscriber number which is contained on the SIM card. |
| MSK | Minimum Shift Keying. A form of digital modulation in which a frequency shift is chosen to exactly twice the data bit rate. It is called minimum shift keying because the frequency spacing between the two frequency states is the minimum spacing that allows the two frequency states to be orthogonal to each other. |
| PCS1900 | Personal Communications System. This is a system used in the USA, bands have been released around 1.9 GHz. |
| PRBS | Pseudo-Random Bit Sequence. A pattern of bits used in bit error testing. |
| Pulsed RF Power | An in-channel, test of the mobile phone's ability to correctly turn its transmitter on and off. |
| RACH | RACH (Random Access Channel) is used to grab the attention of the BS. RACH is a special short burst used to inform the mobile of its timing advance. These bursts are short to avoid collisions with other timeslots. |

| | |
|----------------------|--|
| RPE-LTP | Regular Pulse Excitation Long Term Prediction. A commonly used technique for converting voice from analog to digital form. This is the CODEC that is used by GSM, DCS1800 and PCS1900 systems. |
| RSSI | Received Signal Strength Indicator. Reception level. |
| SACCH | There is a spare frame every 12 TCH frames and this is used for the SACCH (Slow Associated Control Channel). On the down-link, the SACCH is used to send slowly but regularly changing control information to the mobile. The up-link carries information about the received signal strength (RXLev) and quality (RXQual)of the TCH and the adjacent cell BCH measurement. |
| SDCCH | The SDCCH (Stand-alone Dedicated Control Channel) is sometimes configured on a BCH and sometimes on its own physical channel. The SDCCH has a different multiframe structure to the TCH. SDCCH bursts repeat less frequently than one per frame. For this reason, more than 8 SDCCH can share a physical channel. The data rate on a SDCCH is lower than on the TCH. During the call set-up process, there can be a lot of time between the mobile sending a RACH and getting service, to the start of the conversation. During this period, no speech is transmitted (though communication does take place). This transitional time means less of the cells resource are used, the SDCCH improves efficiency and provides a useful holding channel for the mobile until, speech data needs to be exchanged. |
| SIM | The SIM (Subscriber ID Module) card plugs into every GSM mobile and holds all the unique subscriber information. It also stores dialing lists, network allowable usage etc. |
| SMSCB | Short Message Service Cell Broadcast. This service is analogous to the Teletext service offered on television. It permits a number of unacknowledged general messages to be broadcast to all mobiles in a particular region. |
| Speech Coder | An electronic circuit that converts the audio signal into data and minimizes the number of bits needed to represent the audio. |
| Trigger Delay | The time delay between a valid trigger event and the digital demodulation of the signal, or the delay between the trigger event and the beginning of a measurement. |

Glossary

Index

A

ABORTS, A-8
 from the Agilent 8922M, A-8
 sending to HP/Agilent 37900D, A-8
absolute radio frequency channel
 number, 4-17, 4-18, 4-23, 4-24, 4-37, 4-64
ac coupling
 AF generator, 4-111
AC Level
 Audio, 4-4
Activated
 Cell Configuration, 4-16, 4-22
active cell+
 single/hop, 4-32
address
 external disk, 4-59
Adj Cell
 Cell Control, 4-37
adjacent cell, 4-37
AF analyzer input, 4-4, 4-75, 4-77, 4-80
AF Anl In
 Audio, 4-4
AF Freq
 Audio, 4-4
AF Frequency measurement
 selection, 4-4
AF generator, 4-111
AGC
 RF analyzer, 4-112
AGC Mode
 RF Analyzer, 4-112
AllFS, 4-10, 4-14
AM Mod
 Audio, 4-4, 4-75, 4-77, 4-80
Ampl1-12
 Pwr Ramp (Summary), 4-101
Amplitude
 AF Generator, 4-111
 bit error ratio, 4-5
 Bit Error Test, 4-8, 4-12, 4-17, 4-23, 4-37
 CW Meas, 4-54
 Output RF Spectrum (Main View), 4-82
 Output RF Spectrum (Trace View), 4-84
 Phase/Freq (Main), 4-86
 Phase/Freq (Multi-burst), 4-88
 Pulse, 4-104
 Pulse Fall, 4-109
 Pulse Rise, 4-107
 Pwr Ramp (Fall Edge), 4-99
 Pwr Ramp (Rise Edge), 4-95
 Pwr Ramp (Summary), 4-101
 Pwr Ramp (Top 2 dB), 4-97
 RF Analyzer, 4-113
 RF Generator, 4-115
 Spectrum Analyzer (RF Gen Controls), 4-124
amplitude
 negative peak, 4-102
 positive peak, 4-102
 RF generator, 4-12, 4-17, 4-23, 4-37
analog meter, 5-6
AnqAck, 8-6
ANSI Terminal, Configuring, 8-6
ARFCN, 4-18, 4-24
 Cell Configuration, 4-17, 4-23
 Cell Control, 4-37
 Measurement Sync, 4-64
assign
 keys, 5-3
Atten Hold
 RF Generator, 4-115
audio frequency generator, 4-111
Audio In
 Audio, 4-4, 4-75, 4-77, 4-80
Audio In Lo
 Audio, 4-5
audio input
 floating, 4-5
 grounded, 4-5
Audio Out
 Audio, 4-4, 4-75, 4-77, 4-80
Auto
 Bit Error Test, 4-13
auto all
 range hold, 4-51
Auto/Norm
 Oscilloscope (Trigger Controls), 4-78
automatic gain control
 RF analyzer, 4-112
automatic level control
 speaker, 4-6

autostart, 8-32
Aux BCCH
 Cell Configuration, 4-18, 4-24
Aux RF In
 Configure, 4-49
Aux RF Out
 Configure, 4-50
average
 keys, 5-3
 transmitted power, 4-96, 4-98, 4-100
averaging
 measurements, 5-3
Avg TX Pwr
 Pwr Ramp (Fall Edge), 4-100
 Pwr Ramp (Rise Edge), 4-96
 Pwr Ramp (Top 2 dB), 4-98

B

BA
 Cell Configuration, 4-18, 4-24
backing up
 memory card files, 8-23
bad sync message, 7-4
Bad Syncs
 Cell Control, 4-31, 4-37
base station allocation, 4-18, 4-24
base station identity code, 4-20, 4-26
battery
 discarding, 8-25
 in SRAM memory cards, 8-23
 replacing on memory cards, 8-24
 warning, 8-25
battery holder, 8-24
baud rate, 4-62
BCC
 Cell Configuration, 4-18, 4-24
BE Count
 Bit Error Test, 4-8, 4-12, 4-13
BE Ratio
 Bit Error Test, 4-8, 4-12, 4-13
Beeper
 Configure, 4-50
Bit Error
 Round Trip Delay, 4-9
Bits Tested

Index

- Bit Error Test, 4-12
 - Bits to Test
 - Bit Error Test, 4-12
 - buffers, A-11
 - Burst Length
 - Measurement Sync, 4-64
 - Burst Number
 - Measurement Sync, 4-64
 - Burst Sel
 - Measurement Sync, 4-65
 - burst selection
 - measurement synchronization, 4-65
 - Burst Type
 - Measurement Sync, 4-65
 - Burst Used
 - Measurement Sync, 4-65
 - Bursts
 - Phase/Freq (Data bits), 4-93
 - Phase/Freq (Phase Err), 4-91
 - bursts measured, 4-90
- C**
- CA
 - Cell Configuration, 4-18, 4-24
 - cache, A-10
 - buffers, A-11
 - call count
 - reset, 4-43
 - call counts
 - frame errors, 4-31, 4-39
 - pages, 4-42
 - RACHs, 4-43
 - Call Status
 - Cell Control, 4-38
 - Caller
 - Cell Control, 4-38
 - Camping On, A-5
 - LAC, A-5
 - MCC, A-5
 - MNC, A-5
 - More information, A-5
 - Power level, A-5
 - camping on, 4-71
 - cancel
 - keys, 5-3
 - CBCH, 4-119
 - cell allocation, 4-18, 4-24
 - cell configurationscreen
 - keys, 5-4
 - cell control
 - active cell+, 4-31
 - cell control screen
 - keys, 5-3
 - Center Freq
 - Spectrum Analyzer (Main Controls), 4-123
 - Center Freq (Marker To)
 - Spectrum Analyzer (Marker Controls), 4-125
 - center frequency
 - spectrum analyzer, 4-123, 4-125
 - Clear Log, A-10, A-11
 - Agilent 8922M, A-10
 - Logging, A-11
 - clock input
 - connector, 6-3
 - clock input selection, 4-18, 4-24
 - clock output
 - connector, 6-3
 - closed-loop AGC
 - RF analyzer, 4-112
 - Code Files, 8-37
 - Code files, 8-2
 - color code, 4-18, 4-24
 - command line, 8-16
 - comments
 - for the Output Heading field, 8-31
 - communication failure message, 7-2
 - completed bits tested
 - Bit Error Test, 4-9, 4-12, 4-15
 - CONFIGURE, 8-5
 - CONFIGURE Screen
 - Aux RF Out, 4-50
 - Connect
 - Cell Control, 4-39
 - Connection, A-2, A-4
 - Agilent 8922M to HP/Agilent 37900D, A-4
 - bar graphs, A-9
 - checking, A-8
 - diagram, A-4
 - indication, A-9
 - verification, A-9
 - connector
 - protocol interface, A-2
 - connectors
 - 10 MHz output, 6-10
 - 13 MHz output, 6-10
 - AM input, 6-11
 - AM/Speech input, 6-4
 - audio input (high), 6-5
 - audio input (low), 6-5
 - audio output, 6-7
 - auxiliary RF input, 6-2
 - auxiliary RF output, 6-2
 - clock, 6-3
 - clock output, 6-3
 - data input/output, 6-6
 - data output, 6-4
 - EMMI bus, 6-11
 - FM output, 6-4
 - GPIB, 6-12
 - monitor, 6-7
 - opt 001 reference output, 6-14
 - oscilloscope input, 6-8
 - Parallel Port, 6-15
 - PCN Interface, 6-15
 - Protocol Interface, 6-16
 - pulse modulation, 6-8
 - pulse output, 6-7
 - reference input, 6-16
 - reference output, 6-14
 - RF input/output, 6-8
 - serial port, 6-17
 - speech, 6-7
 - system bus, 6-17
 - trigger input, 6-9
 - valid data, 6-9
 - video output, 6-17
 - Cont/Single
 - Oscilloscope (Trigger Controls), 4-78
 - Control
 - Bit Error Test, 4-10
 - RF Analyzer, 4-113
 - Control Ch
 - Cell Config, 4-19, 4-25
 - control channel, 4-19, 4-25
 - Control mode, 4-60
 - Controls
 - Oscilloscope, 4-76
 - Spectrum Analyzer (AuxiliaryCon-

Index-2

Index

- trols), 4-127
- Spectrum Analyzer (Main Controls), 4-122
- Spectrum Analyzer (Marker Controls), 4-125
- Spectrum Analyzer (RF Gen Controls), 4-124
- COPY_PL program, 8-21
 - how to run, 8-23
- country code, 4-20, 4-26
- Coupling
 - AF Generator, 4-111
- coupling
 - bit error ratio, 4-5
- Creating A Library, 8-44
- Creating A Procedure, 8-44
- CRT
 - for showing test results, 8-31
- CW Freq
 - CW Meas, 4-54
- CW Power
 - CW Meas, 4-55
- CWFreqErr
 - CW Meas, 4-54
- cyclic-redundancy-check, 4-9, 4-12

D

- data bits, 4-93
- data bits measurement, 2-19
- Data Collection, 8-35
 - record size, 8-35
- data input selection, 4-18, 4-24
- Data Length, 8-6
 - Configure, 4-59
- DataLink, A-12
- Date
 - Configure, 4-50
- DC AM
 - RF Generator, 4-115, 4-116
- dc coupling
 - AF generator, 4-111
- DCS1800
 - input attenuation, 4-127
- device programmer, 8-23
- discontinuous transmission, 4-40

- disk address, 4-59
- Display Logging Screen
 - HP/Agilent 37900D, A-8
- Display Messages, A-9
- Do Open Cal
 - RF Analyzer, 4-113
- Done
 - Phase/Freq (Multi-burst), 4-88
- Downlink messages, A-10
- Download A Program, 8-10
- download code files, 8-23
- DRX
 - Cell Control, 4-40
- DTX
 - Cell Control, 4-40

E

- echo, 4-60
- Echo Delay
 - Cell Control, 4-5, 4-40
- E-GSM
 - channel number, 4-31, 4-34, 4-35
 - input attenuation, 4-127
- end call
 - keys, 5-4
- ending a call, A-10
- Equipment required, A-3
- equipment supplied, 1-2
- ERROR 85, 8-21
- error message
 - what to do, 2-30
- errors detected, 4-89
- Execute
 - Cell Control, 4-40
- Ext Load R
 - Audio, 4-5
- external disk specification
 - Configure, 4-59
- external load resistance, 4-5
- external protocol logger, A-2

F

- Fall Pos

- Pulse, 4-104
- Fast Bit Error
 - Round Trip Delay, 4-58
- ff at end
 - I/O configuration, 4-59
- ff at start
 - I/O configuration, 4-59
- field types
 - alphanumeric, 4-2
 - data entry, 4-2
 - list of choices, 4-2
 - underlined entry, 4-3
- File Descriptions, 8-37
- Firmware
 - Configure, 4-50
- Firmware Error, 7-3
- firmware revision date, 4-50
- First bit
 - Measurement Sync, 4-66
- Flatness
 - Pwr Ramp (Summary), 4-102
- Flush Log, A-11
 - Logging, A-11
- FM Demod
 - Audio, 4-4, 4-75, 4-77, 4-80
- FM error message, 7-4
- FM Errors
 - Measurement Sync, 4-66
- form feed
 - for test results printout, 8-35
 - I/O configuration, 4-60
- frame erasure, 4-9, 4-12
- Frame Errors
 - Cell Control, 4-39
- frame errors
 - call counts, 4-31, 4-39
- Freq Offs
 - Output RF Spectrum (Main View), 4-82
- Frequency
 - AF Generator, 4-111
 - RF Analyzer, 4-113
 - RF Generator, 4-116
 - Spectrum Analyzer (RF Gen Controls), 4-124
- frequency
 - bit error ratio, 4-5
 - CW, 4-54

Index

frequency analyzer test, 3-10
Frequency Error
 Phase/Freq, 4-86
 Phase/Freq (Multi-burst), 4-89
frequency error
 continuous wave, 4-54
frequency error measurement, 2-15
frequency generator test, 3-9
frequency offset
 output RF spectrum, 4-82
 spectrum analyzer, 4-123
frequency span
 spectrum analyzer, 4-123
fuse, 1-3
FW Revision
 Configure, 4-50

G

G1
 keys, 5-11
G2
 keys, 5-11
G3
 keys, 5-11
gate time
 RF Analyzer, 4-55
global (G1, G2, G3)
 keys, 5-3
global keys, 5-11
GMSK
 RF Generator, 4-116
GMSK modulation test
 RF analyzer, 3-11
 signal generator, 3-9
GPIO
 address, 8-35
 instruments on the "700" bus, 8-35
GPIO address, 3-6
 keys, 5-3
 selecting, 4-60
GPIO Adrs, 8-5
 Configure, 4-60
GPIO command syntax, 8-3
GPIO Control, A-12
GPIO Mode, Control, 8-3

GPIO Mode, Talk&Listen, 8-3
GPIO port, 8-5
GPIO printer, 8-31
GSM900
 input attenuation, 4-127

H

handovers, A-10
high limit
 keys, 5-4
 setting, 5-4
 turn off, 5-4
high stability time base
 option 001, 4-51
hold
 keys, 5-4
hold all
 range hold, 4-51
Hop Meas Freq
 RF Analyzer, 4-113
Hop Mode
 RF Analyzer, 4-113
 RF Generator, 4-116
Hop Offset
 RF Analyzer, 4-113
Hop Trig
 RF Analyzer, 4-114
 RF Generator, 4-116
How to
 obtain a Protocol Log, A-8
HP AdvanceLink, 8-7
HP/Agilent 15756A Interface Cable, A-3
HP/Agilent 37900D, A-11
HP/Agilent 37900D Option 004, A-3
HP/Agilent 37910A Slave Signalling
 Card, A-3
HP/Agilent 37913A RS232/449 Interface
 Card, A-3
HP/Agilent 37966A GSM software, A-3
HP/Agilent 37967A protocol monitor
 application software, A-3
HP/Agilent 8922M Option 003, A-3

I

IBASIC computer
 initializing memory cards, 8-21
 may be programmed, 8-29
 to configure external instruments, 8-35
IBASIC Echo, 8-6, 8-9
 Configure, 4-60
IBASIC programming-language code, 8-29
IBASIC programs
 file structures, 8-29
 user written, 8-29
IMSI attach/detach, 4-71
increment
 keys, 5-4
initializing memory cards, 8-21
input amplitude
 CW Meas, 4-54
Input Atten
 Spectrum Analyzer (Auxiliary Controls), 4-127
input attenuation
 DCS1800 radio, 4-127
 E-GSM radio, 4-127
 GSM900 radio, 4-127
input attenuator
 spectrum analyzer, 4-127
Inst Echo, 8-6, 8-9
 Configure, 4-60
installation
 overview, 1-5
installing software, 3-5
instrument setup
 recall, 5-7
 save, 5-9
Intensity
 Configure, 4-50
Interface Card, A-6
interfacing techniques, 8-29
intermediate bits tested
 Bit Error Test, 4-8
internal control bus, 8-3

Index

K

keys, 5-2
 assign, 5-3
 average, 5-3
 cancel, 5-3
 cell configuration screen, 5-4
 cell control screen, 5-3
 end call, 5-4
 G1, 5-11
 G2, 5-11
 G3, 5-11
 global (G1, G2, G3), 5-3
 GPIB address, 5-3
 high limit, 5-4
 hold, 5-4
 increment, 5-4
 L1, 5-10
 L2, 5-10
 local (L1, L2), 5-3
 low limit, 5-5
 measurement arming, 5-5
 measurement synchronization screen,
 5-6
 message screen, 5-6
 meter, 5-6
 mobile station information screen, 5-6
 no, 5-6
 on/off, 5-6
 originate call, 5-6
 previous, 5-6
 print, 5-6
 recall, 5-7
 receive call, 5-7
 reference set, 5-8
 release, 5-8
 RF analyzer screen, 5-9
 RF generator screen, 5-9
 save, 5-9
 tests screen, 5-9
 use memory, 5-9
 yes, 5-9

L

L1

 keys, 5-10
L2
 keys, 5-10
LAC
 Cell Config, 4-19, 4-25
LAI
 Cell Config, 4-20, 4-26
level
 oscilloscope, 4-76
Level (div)
 Oscilloscope (Trigger Controls), 4-78
level late message, 7-4
level short message, 7-4
level test
 RF Analyzer, 3-11
 Signal Generator, 3-7
Library Files, 8-37
Library files, 8-2
Limit
 Cell Control, 4-40
line feed
 I/O configuration, 4-60
line voltage, 1-3
lines/page
 I/O configuration, 4-60
Loading A Program, 8-10
local (L1, L2)
 keys, 5-3
local keys, 5-10
location
 area code, 4-19, 4-25
 area identification, 4-20, 4-26
 update, 4-71
Log, A-11
Log/Pause, A-11
 Logging, A-11
Logging Messages, A-11
Logging Screen, A-11
 aborts, A-8
 clear log, A-11
 DataLink, A-12
 flush log, A-11
 Log/Pause, A-11
 NetwkOnly, A-12
 options, A-5
 Pass Filter, A-12
 selecting, A-5, A-11
 Service, A-12

 set up, A-5
Logging screen, A-5
Logging start-up, A-9
Loop Delay Speech Frames
 Bit Error Test, 4-15, 4-58
Loopback
 Bit Error Test, 4-13
 Cell Control, 4-40
low level message, 7-4
low limit
 keys, 5-5
 setting, 5-5
 turn off, 5-5
Lvl
 Pulse Fall, 4-109
 Pulse Rise, 4-107

M

MA1
 Cell Configuration, 4-19, 4-25
 Cell Control, 4-40
MA2
 Cell Configuration, 4-20, 4-25
main screen, 4-27, 4-33, 4-35
MAIO1
 Cell Configuration, 4-20, 4-26
MAIO2
 Cell Configuration, 4-20, 4-26
Making a Call, A-9
 HP/Agilent 37900D, A-9
Marker
 Oscilloscope (Main Controls), 4-76
 Oscilloscope (Marker Controls), 4-81
 Output RF Spectrum (Trace View), 4-
 84
 Pwr Ramp (Fall Edge), 4-99
 Pwr Ramp (Rise Edge), 4-95
 Pwr Ramp (Top 2 dB), 4-97
 Spectrum Analyzer (Main Controls), 4-
 123
 Spectrum Analyzer (Marker Controls),
 4-125
 Spectrum Analyzer (RF Gen Controls),
 4-124
Marker Pos

Index

- Output RF Spectrum (Trace View), 4-85
- Phase/Freq (Phase Err), 4-91
- Pwr Ramp (Fall Edge), 4-100
- Pwr Ramp (Rise Edge), 4-95
- Pwr Ramp (Top 2 dB), 4-97
- marker position, 4-97, 4-100
 - pulse fall, 4-110
 - pulse on/off ratio, 4-107
- Marker To Peak+
 - Oscilloscope (Marker Controls), 4-81
- Marker To, Ref Level
 - Spectrum Analyzer (Marker Controls), 4-126
- Markerl
 - Oscilloscope (Trigger Controls), 4-78
- MarkerPos
 - Pulse Fall, 4-110
 - Pulse Rise, 4-107
- Mask
 - Pwr Ramp (Fall Edge), 4-100
 - Pwr Ramp (Rise Edge), 4-96
 - Pwr Ramp (Top 2 dB), 4-98
- Max Hold
 - Spectrum Analyzer (Main Controls), 4-123
- MCC
 - Cell Config, 4-20, 4-26
- Meas Cntl
 - Bit Error Test, 4-14
- Meas Num
 - Bit Error Test, 4-12
- Meas Reset
 - Audio, 4-6
 - Configure, 4-51
 - CW Meas, 4-55
 - Oscilloscope (Main Controls), 4-76
 - Oscilloscope (Marker Controls), 4-81
 - Oscilloscope (Trigger Controls), 4-78
 - Spectrum Analyzer (MainControls), 4-123
- Measurement
 - Bit Error Test, 4-13
- measurement arming
 - keys, 5-5
- measurement averaging, 5-3
- measurement control, 4-10, 4-14
- Measurement Summary
 - Pwr Ramp (Summary), 4-102
 - measurement summary message, 2-17
 - measurement synchronization, 4-64
 - measurement synchronization screen
 - keys, 5-6
 - memory cards
 - backing up programs, 8-23
 - batteries, 8-24
 - COPY_PL program, 8-23
 - initializing, 8-21
 - inserting and removing, 8-20
 - SRAM and OPT part numbers, 8-21
 - write-protect switch, 8-22
 - message screen
 - keys, 5-6
 - messages, 7-1
 - bad sync, 7-4
 - Communication Failures, 7-2
 - Firmware Errors, 7-3
 - FM error, 7-4
 - level late, 7-4
 - level short, 7-4
 - low level, 7-4
 - measurement summary, 2-17
 - no error, 7-4
 - protocol errors, 7-5
 - RF overload, 7-4
 - short burst, 7-4
 - sync status, 7-4
 - meter
 - keys, 5-6
 - Midamble
 - Measurement Sync, 4-66
 - Midamble Start Bit Position
 - Measurement Sync, 4-67
 - MM
 - Cell Control, 4-41
 - MNC
 - Cell Config, 4-20, 4-26
 - mobile
 - country code, 4-20, 4-26
 - network code, 4-20, 4-26
 - mobile allocation
 - number, 4-40
 - number 1, 4-19, 4-25
 - number 2, 4-20, 4-25
 - mobile allocation index
 - offset 1, 4-20, 4-26
 - offset 2, 4-20, 4-26
 - mobile station
 - information, 4-70
 - timing error, 4-43
 - mobile station information screen
 - keys, 5-6
 - mobility management, 4-41
 - Mode
 - Cell Control, 4-41
 - Configure, 4-60
 - Output RF Spectrum (Main View), 4-83
 - Mode field, 8-5
 - model
 - I/O configuration, 4-60
 - modulation
 - output RF spectrum power, 4-83
 - multi-burst measurements, 2-15

N

 - NCC
 - Cell Configuration, 4-20, 4-26
 - NetwkOnly, A-12
 - Next Peak (Marker To)
 - Spectrum Analyzer (Marker Controls), 4-125
 - no
 - keys, 5-6
 - no error message, 7-4
 - Norm
 - Cell Control, 4-41

O

 - Off, 4-10, 4-14
 - Offset
 - Configure, 4-51
 - On UUT Failure
 - continue or stop, 8-29
 - On/Off
 - Phase/Freq (Multi-burst), 4-89
 - on/off
 - keys, 5-6
 - One-Time Programmable

Index-6

Index

- OTP memory cards, 8-21
- open loop AGC calibration
 - RF analyzer, 4-113
- Open/Auto DAC Value
 - RF Analyzer, 4-114
- open-loop AGC
 - RF analyzer, 4-112
- operating environment, 1-8
- Opt 001 Ref Out, 4-51
- options, 1-8
- originate call
 - keys, 5-6
- oscilloscope, 4-75
 - arming, 4-78
 - trigger level, 4-78
 - triggering, 4-78
- oscilloscope test, 3-10
- Other fusing, 1-3
- Output Destination
 - CRT or Printer, 8-31
- Output Heading comments, 8-31
- Output Results
 - All or Failures, 8-30
- Output RF Spectrum
 - Output RF Spectrum (Main View), 4-83
- output rf spectrum
 - cell control, 4-28
- output RF spectrum measurement, 2-20
- OutRFSpec
 - Output RF Spectrum (Trace View), 4-85
- P**
- Pages
 - Cell Control, 4-42
- pages
 - call counts, 4-42
- Paging
 - Cell Control, 4-42
- Parallel Port
 - connector, 6-15
- parameters
 - enter into Test Executive, 8-34
- Parity, 8-6
 - Configure, 4-61
- Pass Filter, A-12
 - Logging, A-12
- Pause, A-11
- PCN interface
 - connector, 6-15
- Peak (Marker To)
 - Spectrum Analyzer (Marker Controls), 4-125
- peak carrier power measurement, 2-14
- Peak Phase Error
 - Phase/Freq (Main), 4-87
 - Phase/Freq (Multi-burst), 4-89
- peak power
 - cell control, 4-28
- peak transmitted power, 4-102
- performance test software, 3-5
- performance tests, 3-2
- performance verification, 3-2
- Personality, A-6, A-7
 - setting, A-6, A-7
- phase and frequency
 - cell control, 4-28
- phase error, 4-91
- phase error measurement, 2-15
- Pk TX Pwr
 - Pwr Ramp (Summary), 4-102
- Pls Demod
 - Audio, 4-4, 4-75, 4-77, 4-80
- Polarity
 - Phase/Freq (Data Bits), 4-94
- POnOffFall
 - Pulse Fall, 4-110
- POnOffRise
 - Pulse Rise, 4-108
- Pos/Neg
 - Oscilloscope (Trigger Controls), 4-78
- Position
 - Oscilloscope (Marker Controls), 4-81
 - Spectrum Analyzer (Marker Controls), 4-126
- power
 - continuous wave, 4-55
- power cord, 1-4
- power meter
 - zeroing, 4-29, 4-55, 4-103
- power ramp measurement, 2-16
- power supply
 - configure to GPIB, 8-35
- ppm, 4-14
- PRBS, 4-42
- PRBS Pattnr, 4-42
- Pre-Trig
 - Oscilloscope (Trigger Controls), 4-78
- previous
 - keys, 5-6
- print
 - keys, 5-6
 - print address
 - selecting, 4-61
 - Print Adrs, 8-5
 - Configure, 4-61
 - Print Cancel
 - Configure, 4-61
 - Print Title
 - Configure, 4-61
 - Print To, 8-5
- printer
 - configure to GPIB, 8-35
 - for showing test results, 8-31
 - options, 8-35
 - RS-232 or GPIB, 8-31
- printer port
 - I/O configuration, 4-61
- printouts
 - for the test results, 8-30
- problem solving, 2-30
- Procedure Files, 8-26
- Procedure files, 8-2
- Program Development Tools disk, 8-16
- Program Example, 8-37
- PROGram Interface Commands, 8-16
- Program Listing Explanation, 8-40
- program status
 - run indicators, 8-29
- Program Structure, 8-37
- programming techniques, 8-29
- programs
 - IBASIC file structures, 8-29
- protocol buffer, A-8
- protocol error messages, 7-5
- protocol interface connector, A-2
- Protocol Interface Port, A-11
- protocol messages, A-8
- Protocol Monitor, A-11
- protocol units, A-8

Index

Pseudo-Random Bit Sequence, 4-42
Pulse
 RF Generator, 4-117
pulse demodulation test
 RF analyzer, 3-12
pulse measurement, 2-16
pulse modulation
 RF generator, 4-117
pulse modulation test, 3-8
Pulse On/Off Fall
 Pulse, 4-105
pulse on/off ratio, 4-104
Pulse On/Off Rise
 Pulse, 4-105
Pwr Ramp
 Summary, 4-101

R

RACHs
 call counts, 4-43
 Cell Control, 4-43
radio frequency analyzer, 4-112
radio frequency generator, 4-115
radio specifications, 8-33
radio tests
 reduce testing time, 8-33
 selecting, 8-32
ramping
 output RF spectrum power, 4-83
Range Hold
 Configure, 4-51
Rcv Pace, 8-6
 Configure, 4-62
read-only setting
 on the memory card, 8-22
read-write setting
 on the memory card, 8-22
recall
 keys, 5-7
receive call
 keys, 5-7
receive pacing
 setting, 4-62
Receive/Transmit Pacing, 8-6
record size
 for data collection, 8-35
Ref Level
 Spectrum Analyzer (Main Controls), 4-123
Ref Level (Marker To)
 Spectrum Analyzer (Marker Controls), 4-126
Reference
 Configure, 4-52
reference
 setting, 5-8
reference level
 RF Input, 4-123
reference output
 option 001, 4-51
reference set
 keys, 5-8
Relative MS Timing Err
 Cell Control, 4-43
release
 keys, 5-8
Remote control, A-12
ResAllFS, 4-10, 4-14
Reset
 Cell Control, 4-43
 Oscilloscope (Trigger Controls), 4-79
reset
 call count, 4-43
 cell control, 4-29
 measurement, 4-51, 4-76, 4-78
 SACCH Meas, 4-43
ResTypeI, 4-10, 4-14
ResTypeIa, 4-10, 4-14
ResTypeIB, 4-10, 4-14
ResTypeII, 4-10, 4-14
RF analyzer, 4-112
RF analyzer screen
 keys, 5-9
RF Anl Ampl Control
 Cell Control, 4-44
RF Cnt Gate
 CW Meas, 4-55
RF generator, 4-115
 amplitude, 4-8, 4-12, 4-17, 4-23, 4-37
RF generator screen
 keys, 5-9
RF In/Out
 Configure, 4-52

RF Input
 CW Meas, 4-55
 RF Analyzer, 4-114
 Spectrum Analyzer (Auxiliary Controls), 4-128
RF Level Offset
 Configure, 4-53
RF Output
 RF Generator, 4-117
RF overload message, 7-4
RF spectrum measurement, 2-20
RFGen Volts
 Configure, 4-52
Rise Pos
 Pulse, 4-105
RJ-11/RS-232 adapter, 8-5
RMS Error
 Phase/Freq (Multi-burst), 4-89
RMS Phase Error
 Phase/Freq (Main), 4-87
RS-232 printer, 8-31
RS-232 Serial port, 8-5
Run Mode
 Continuous or Single Step, 8-30
Run Test, 8-15
Run/Stop
 Control, 4-10
 Meas Cntl, 4-14

S

SACCH Meas
 Cell Control, 4-45
save
 keys, 5-9
Save Programs On Memory Cards, 8-10
scope
 cell control, 4-29
Scope In
 Audio, 4-4, 4-75, 4-77, 4-80
Scope Lvl
 Oscilloscope (Trigger Controls), 4-79
Screen Freeze
 Configure, 4-53
screens, 4-1
 active cell+, 4-31

Index

- Audio, 4-4
- Bit Error, 4-8, 4-11
- Cell Configuration - DCS 1800, 4-22
- Cell Configuration - E-GSM, 4-22
- Cell Configuration - E-GSM900, 4-22
- Cell Configuration - GSM, 4-16
- Cell Configuration - GSM 900, 4-16
- Cell Configuration - PCS 1900, 4-22
- Cell Control, 4-37
- Configure, 4-49
- CW Meas, 4-54
- Data Bits, 4-93
- Fast Bit Error, 4-56
- hopping, 4-32
- I/O Configuration, 4-59
- Logging, 4-63, A-11
- main, 4-27, 4-33, 4-35
- Measurement Sync, 4-64
- Message, 4-69
- Mobile, 4-57
- Mode, 4-57
- MS Information / Signaling, 4-70
- Oscilloscope (Marker Controls), 4-80
- Oscilloscope, Main Controls, 4-75
- Oscilloscope, Trigger Controls, 4-77
- Output RF Spectrum (Main View), 4-82
- Output RF Spectrum (Trace View), 4-84
- Phase Err, 4-91
- Pulse, 4-104
- Pulse Fall, 4-109
- Pulse Rise, 4-107
- Pwr Ramp (Fall Edge), 4-99
- Pwr Ramp (Rise Edge), 4-95
- Pwr Ramp (Summary), 4-101
- Pwr Ramp (Top 2 dB), 4-97
- RF Generator / RF Analyzer (AF Gen), 4-111
- RF Generator / RF Analyzer (RF Analyzer), 4-112
- RF Generator / RF Analyzer (RF Gen), 4-115
- Service, 4-118
- SMS cell broadcast, 4-119
- Spectrum Analyzer (Auxiliary Controls), 4-127
- Spectrum Analyzer (Main Controls), 4-122
- Spectrum Analyzer (Marker Controls), 4-125
- Spectrum Analyzer (RF Gen Controls), 4-124
- SD/4, 4-19, 4-25
- SD/8, 4-19, 4-25
- Serial Baud, 8-6
- Configure, 4-62
- Serial In
- Configure, 4-62
- Serial In Field, 8-6
- serial input port
- control, 4-62
- serial interface
- pin numbers, 6-17
- Serial Port, 8-5
- Serial Port Connections, 8-5
- serial word length, 4-59
- Service, A-12
- Configure, 4-53
- serving cell, 4-20, 4-26
- Settable
- Cell Configuration, 4-21, 4-26
- Setting
- Interface Card, A-6
- setting high limit, 5-4
- setting low limit, 5-5
- setting reference, 5-8
- Setting up the Agilent 8922M, A-5
- Setting up the HP/Agilent 37900D, A-6
- ShortBurst message, 7-4
- signaling, 4-70
- Single/Cont
- Control, 4-10
- Meas Cntl, 4-14
- Measurement Sync, 4-67
- Phase/Freq (Main), 4-87
- Phase/Freq (Multi-burst), 4-89
- single/Cont
- Pulse, 4-105
- slow associated control channel, 4-45
- Software, A-6
- HP/Agilent 37900D, A-6
- HP/Agilent 37966B, A-6
- HP/Agilent 37967A, A-6
- Span
- Spectrum Analyzer (Main Controls), 4-123
- speaker
- off, 4-6
- volume control, 4-6
- Speaker ALC, 4-6
- Speaker Vol
- Audio, 4-6
- specifications
- enter into Test Executive, 8-33
- spectral purity test, 3-8
- spectrum analyzer
- cell control, 4-29
- spectrum analyzer test, 3-12
- Speech
- Cell Control, 4-7, 4-46
- Speech Gain
- Cell Control, 4-47
- SRAM memory cards
- contain a battery, 8-23
- initializing, 8-21
- write protection, 8-22
- Static Random-Access Memory
- SRAM memory cards, 8-21
- Status
- Digital Demod, 4-67
- Stop Length, 8-6
- Configure, 4-62
- Stop logging, A-10
- sweep time
- oscilloscope, 4-76
- sweep trigger
- arming, 4-79
- Sync Mode
- Measurement Sync, 4-67
- Sync Pattern Start Position
- Measurement Sync, 4-67, 4-68
- Sync Status
- Measurement Sync, 4-68
- Output RF Spectrum (Main View), 4-82
- Output RF Spectrum (Trace View), 4-85
- Phase/Freq (Data Bits), 4-94
- Phase/Freq (Main), 4-87
- Phase/Freq (Multi-burst), 4-90
- Phase/Freq (Phase Err), 4-92
- Pulse, 4-105
- Pulse Fall, 4-110

Index

Pulse Rise, 4-108
Pwr Ramp (Fall Edge), 4-100
Pwr Ramp (Rise Edge), 4-96
Pwr Ramp (Summary), 4-102
Pwr Ramp (Top 2 dB), 4-98
sync status message, 7-4
 what to do, 2-30
synchronization errors
 DSP Analyzer, 4-96, 4-98, 4-100, 4-102
 measurement synchronization, 4-68
 output RF spectrum, 4-82
 Output RF Spectrum (Trace View), 4-85
 Phase/Freq, 4-94
 pulse fall, 4-110
 pulse on/off ratio, 4-105
 pulse rise, 4-108
synchronization mode
 measurement synchronization, 4-67
system bus, 6-18
 pin number overview, 6-18
 signal descriptions, 6-18
system information, A-10

T

Talk&Listn mode, 4-60
TCH Control
 Cell Control, 4-47
TCH parameters, 4-47
TCH Params
 Cell Control, 4-47
Test
 Cell Control, 4-47
test equipment, 3-4
Test Execution Conditions, 8-29
Test Executive
 parameters, 8-34
 specifications, 8-33
 test sequence, 8-32
Test Library files
 backing up, 8-23
Test Parameters, 8-34
Test Procedure files
 backing up, 8-23

Test Sequence
 running a, 8-15
Test Sequence menu, 8-32
Test Specifications, 8-33
testing the radio, 8-15
testing time
 how to reduce, 8-33
tests
 for radios, 8-32
tests screen
 keys, 5-9
TESTS Subsystem, 8-2
Time
 Configure, 4-53
 Phase/Freq (Phase Err), 4-91
time stamps, A-8
 HP/Agilent 37900D, A-8
Time/div
 Oscilloscope (Main Controls), 4-76
Time1-12
 Pwr Ramp (Summary), 4-102
Timeslot
 Cell Control, 4-48
Timing Advance
 Cell Control, 4-48
timing error
 mobile station, 4-43
traffic channel control, 4-47
transmit pacing
 setting, 4-62
transmitter power, 4-48
Trg Timing
 Phase/Freq (Data Bits), 4-94
Trig Delay
 Measurement Sync, 4-68
 Output RF Spectrum (Main View), 4-83
 Output RF Spectrum (Trace View), 4-85
 Phase/Freq (Data Bits), 4-94
 Phase/Freq (Main), 4-87
 Phase/Freq (Multi-burst), 4-90
 Phase/Freq (Phase Err), 4-92
 Pulse, 4-106
 Pulse Fall, 4-110
 Pulse Rise, 4-108
 Pwr Ramp (Fall Edge), 4-100
 Pwr Ramp (Rise Edge), 4-96

 Pwr Ramp (Summary), 4-102
 Pwr Ramp (Top 2 dB), 4-98
Trig Qual
 Measurement Sync, 4-68
Trig Source
 Measurement Sync, 4-68
trigger delay
 DSP Analyzer, 4-100, 4-102
 measurement synchronization, 4-68
 output RF spectrum, 4-85
 Phase/Freq (Data Bits), 4-94
 pulse fall, 4-110
 pulse on/off ratio, 4-106
 pulse rise, 4-108
 Pwr Ramp, 4-96, 4-98
trigger qualifier
 measurement synchronization, 4-68
trigger source
 measurement synchronization, 4-68
 oscilloscope, 4-79
tuning mode
 Configure, 4-52
Type
 Cell Control, 4-48
TypeI, 4-10, 4-14
TypeIa, 4-10, 4-14
TypeIB, 4-10, 4-14
TypeII, 4-10, 4-14

U

units keys, 5-12
Uplink messages, A-10
use memory
 keys, 5-9
Using the Knob, 8-16

V

verifying performance, 3-2
Vert Offset
 Oscilloscope (Main Controls), 4-76
Vert/div
 Oscilloscope (Main Controls), 4-76
vertical offset

Index-10

Index

oscilloscope, 4-76
vertical sensitivity
 oscilloscope, 4-76
View
 Output RF Spectrum (Main View), 4-
 83
 Pwr Ramp, 4-103
volume
 speaker, 4-6

W

Wanted
 Phase/Freq (Multi-burst), 4-89, 4-90
write-protect switch
 setting, 8-22

X

Xmt Pace, 8-6
 Configure, 4-62
Xon/Xoff, 4-62

Y

yes
 keys, 5-9

Z

Zero Power
 CW Meas, 4-55
 Pwr Ramp (Summary), 4-103