



## CoCo ~ 123 Memory Map

<i>Routines</i>	<i>Address</i>
-----	-----
GCCC Officers .....	1
GCCC Information .....	2
CoCo~123 Contributions .....	2
Contributors to this Issue .....	2
GCCC Meetings .....	2
From the President's Platen .....	2
Treasury Notes .....	2
Editor's Clipboard .....	2
Secretary's Notebook .....	2
ARTICLES .....	3
<b>Trek Adventure - It took 31 Years to solve</b> .....	3
<b>RGB to HDMI for the CoCo</b> .....	8
<b>Hi-Res Joystick Interface</b> .....	9
<b>Neutroid 2.015</b> .....	9
<b>The CoCo Crew Podcast</b> .....	10
<b>Xmas Rush</b> .....	10
Calendar of Events .....	11
CoCoFEST! 2016 Information - The 5 "W's" .....	11

### Upcoming Events:

The 25<sup>th</sup> Annual "Last" Chicago CoCoFEST! **April 23-24, 2016**  
Regular meetings every 2nd Thursday @ Schaumburg Library

### G.C.C.C. OFFICERS

-----  
Here is the list of 2015 club officers and how to contact them.  
If you have questions about the association call one of the  
officers for the answers.

<b>POSITION</b>	<b>NAME</b>	<b>PHONE</b>	<b>PRIMARY FUNCTION</b>
-----	-----	-----	-----
President	Tony Podraza	847-428-3576	The buck stops here...
Vice-President	Chris Hawks	815-943-4690	Meeting planning, etc.
Treasurer	Geo Schneeweiss	815-832-4441	Dues and Purchasing
Secretary	Bob Swoger	224-236-5194	Records and Reporting
Director	Tony Podraza	847-428-3576	CoCoFEST! Organizer
Librarian	Brian Goers	708-805-1888	Software/Hrdwr Manager
Editor	John Mark Mobley	847-409-8604	Newsletter Production
-----	-----	-----	-----

Copyright ©2015 Glenside Color Computer Club, Inc.



Tony Podraza



Chris Hawks



Robert Swoger



George Schneeweiss



Brian Goers



John Mark Mobley

CoCo~123 - A Glenside Publication Since 1985

## CoCo~123 INFORMATION

CoCo~123 is the newsletter of the Glenside Color Computer Club. Your annual contribution of \$15.00 helps to keep our club going. Send your check to Glenside Treasurer:

George L Schneeweiss  
13450 N 2700 E Road  
Forrest IL 61741-9629

Our treasury provides newsletters and good times with fellow CoCo users at our Annual "Last" Chicago CoCoFEST! and Annual Glenside Picnic.

## CoCo~123 CONTRIBUTIONS

If you have any suggestions for the newsletter or would like to submit an article, please contact the CoCo~123 Newsletter editor:

John Mark Mobley  
4104 Wren Lane  
Rolling Meadows IL 60008  
johnmarkmelanie@gmail.com

## CONTRIBUTORS TO THIS ISSUE

Salvador Garcia  
John Linville  
John Mark Mobley  
Barry Nelson  
Tony Podraza  
George Schneeweiss

## G. C. C. C. MEETINGS

The Glenside Color Computer Club meets the second Thursday of each month at the Schaumburg Township District Library at 7:00 pm. If you need a map, see our Glenside Homepage at:

<http://glensideccc.com/splmap.html>

A social get-together always follows the meeting at a nearby restaurant, lovingly called, "The Meeting After".

## FROM THE PRESIDENT'S PLATEN

We at Glenside wish you all a **Very Merry Christmas and a Happy New Year!** All of us here at Glenside find ourselves particularly bust this time of year indicated by the tardiness of this newsletter. Rest assured, John Mark and Melanie worked long and hard to get it out.

As another FEST is approaching, not just another but our 25<sup>th</sup> Silver Anniversary FEST, we are still busy figuring out how to make this fest a memorable one. All events and activities should be tied down by the next newsletter due out in March. We hope you will read and enjoy this newsletter and that it will wet your appetite for enjoying the CoCo.

I bid you, PEACE.

Tony Podraza, President  
Glenside Color Computer Club

## TREASURY NOTES

We have \$6032.34 in checking. We have 67 paid members in 2015, down from 136 in 2011, and a total of 290 members to whom we send newsletters.

George Schneeweiss, Trea\$urer  
Glenside Color Computer Club

## THE EDITOR'S CLIPBOARD

In the last newsletter, I asked you to consider becoming the next newsletter editor.

So you've decided to become the next newsletter editor. Now here are the next steps you need to take:

1. Read this newsletter. (Good for you, you already qualify!)
2. Read the GCCC Constitution and Bylaws (which can be found on our website at <http://www.ncmedals.com/glenside/constitu.txt>).
3. Attend the GCCC monthly meetings (second Thursday of the month at 7:00 PM CT) either in person at the Schaumburg library, or by Skype through john.mark.mobley.
4. Tell Tony Podraza you are willing for him to appoint you as newsletter editor.

Bob Swoger holding two jobs was the previous newsletter editor. Either Bob or I would be willing to assist the new newsletter editor during the transition.

There's no monetary pay for this position, but you will be providing an invaluable service to the Club.

The newsletter is the retro way to communicate with the members. Blogs, mailing lists, and chat rooms have their place, but we would like to see the newsletter continue.

John Mark Mobley, Editor  
Glenside Color Computer Club

## THE SECRETARY'S NOTEBOOK

It's good to be back home. Annette and I were in a hotel for seven months waiting for the rebuilders to put the place back together after the fire. Best thing I can recommend to you is if you have a gas meter inside your house, have the gas company move it outdoors because these new ones are now made overseas. Having monitored our gas usage, we find we use much less gas than we did before the explosion. Probably the meter was leaking all along and we never knew it.

Below is an article about the game Trek Adventure by Bob Retelle. As John Mark was developing the article, he asked me to oversee his progress. Knowing we had this game in the LogiCall ensemble, I tried playing the game. Not having the original instructions that must have come with the game made it almost impossible to get started. I am not ordinarily a game player. But in the past I did rewrite a very old game, "HUNT THE WUMPUS", for the Sinclair ZX81 and Timex TS1000

and later converted it to run on the Spectrum and the Timex/Sinclair TS2068. Back about five years ago I again rewrote HUNT THE WUMPUS for the CoCo3. All versions are keystroke for keystroke and screen for screen the same.

The reason I rewrote this game was because I have come across in my lifetime many inept programmers. The examples I can cite are just too many to point out in this article. So I wrote the Sinclair version back in 1981 to teach programmers how to PROGRAM FOR THE USER giving greater delight to those users.

Just like the old HUNT THE WUMPUS, Trek Adventure is a text adventure. In time, any printed instructions for a game usually become lost. Our past librarian, Mary Kramer, spent many hours providing Glenside with restored documentation for the Glenside Library. The instructions are not there.

To fix the lost documentation problem in HUNT THE WUMPUS there is a HELP file available at the beginning of the game at start up. Just to check out the ability of the game to be played, I asked my 6-year-old granddaughter Reagan to play the game and she did with very little help from grandpa. To see the happiness on her face every time she shot the WUMPUS was my reward.

To see where we are at with the LogiCallized Trek Adventure, just go to disk 80 at the "Drive?" prompt and load TREKADV.BAS. At the top of the screen you will now find your purpose for solving this game. If you don't see this sentence, please update your copy of LogiCoCo.zip and run LINSTALL.

At the bottom of your screen you will see the "YOUR COMMAND?" prompt. Rest assured that if you type "Q" or "QUIT" at this prompt, you will be returned to the LogiCall operating system.

At this prompt you can type "H" or "HE" or "HELP" to see the help file containing all the words the program is able to parse. The parser looks only at the first 2 letters of the action word and the first 2 letters of the last object word. Don't take a dump in anything, as it might wind up in your inventory.

As suggested by John Mark, I kept the screen width for the help file at 32 so that the program would still work on the CoCo1 and CoCo2. Some object lines are truncated but enough is there to type in the whole line shown.

My experience with lifts is that most have but one door. This might indicate that the map of the bridge level might be off by 90 degrees, but then again, the lift might have 2 doors.

In space is there a North, South, East and West? These directions might relate to the planet the Enterprise is appreciating. Give that some thought as you note that

the deck level doesn't recognize north, south, east or west.

Since the game could take as long as 31 years to solve, it would be nice if the program had a state save as does DISKS.BAS so that one could return from a non-finished adventure to pick they left off.

Be sure to have a printed copy of John Mark's article by your side when you attempt to run Trek Adventure. Hope this adds more enjoyment to the game.

Bob Swoger, Secretary - rswoger@aol.com  
Glenside Color Computer Club

### **Trek Adventure by John Mark Mobley**

Trek Adventure is interactive fiction, written by Bob Retelle, which is also known as a text adventure (see [http://fanlore.org/wiki/Trek\\_Adventure](http://fanlore.org/wiki/Trek_Adventure)). Interactive fiction is still being produced to this day. Even blind people have been known to enjoy this form of art. Trek Adventure is interactive fiction where you try to save the USS Enterprise (NCC-1701). This is from the television series "Star Trek". As best as I can tell "Star Trek" is a registered trademark of Paramount Pictures and CBS.



USS Enterprise (NCC-1701)

This is a single-user text adventure. Multi-user text adventures are referred to as MUD, which stands for Multi-User Dungeon, Multi-User Dimension, or Multi-User Domain.

I started this adventure about 1984. My friend had a TRS-80 Color Computer 1. It was gray and had a chiclet keyboard. I think we loaded the program from cassette tape. I graduated high school that year and was unable to complete the adventure at that time. In 2015 I got the program from Jim Gerrie and tried to pick up where I left off. I got stuck in about the same place as I got stuck in 1984.

Recently I watched the documentary on text adventures called "Get Lamp" by Jason Scott. I got some ideas from the documentary. I printed and read the source code and got some very useful hints. And then I completed the adventure. Yes, it is possible to complete the adventure, and it only took me 31 years to do it!

The situation is this: The Starship Enterprise is in a decaying orbit around a planet. You are all alone on the ship. You have 240 text entry attempts to repair the starboard engine and restart the engines. If you can do that, you have saved the ship and your own life.

The Kobayashi Maru is a Star Trek simulation that cannot be won without cheating, aka reprogramming the computer. Trek Adventure is not quite that hard, but a little cheating is acceptable. Ex: BREAK, "O=O+20:CONT" will increase the amount of oxygen in the first space suit.

Trek Adventure simulates life on a starship. It warns you not to restart the engines until you have made the necessary repairs. But it does not prevent you from restarting the engines before the repairs have been made, and it simulates what will happen if you try anyway.

The turbolift can take you to all 3 decks. I have mapped the decks. The maps are shown below.

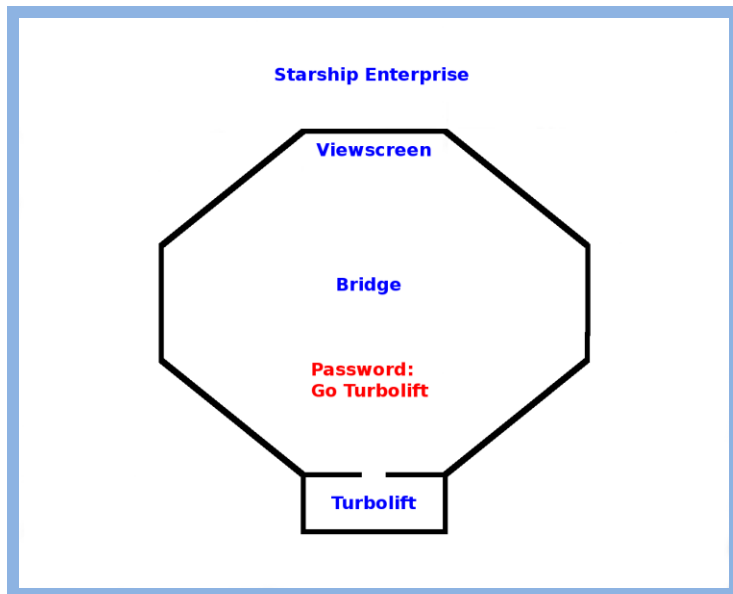

1st Deck of the Starship Enterprise

Trek Adventure text commands are of the form verb, or verb-noun. When typing verbs or nouns, you can just type the first two letters instead of the whole word. There are two stand alone verbs that don't need nouns. They are Inventory and Look. Look is only stand alone if it is completely spelled out. Look is interpreted as Look Around, which can be written as Lo Ar, which is also Look Armory. There are many verb-noun commands, such as Go West.

Below is a list of the verbs and nouns in Trek Adventure. My explanations/examples are in parentheses. In some cases, multiple words can mean the same thing.

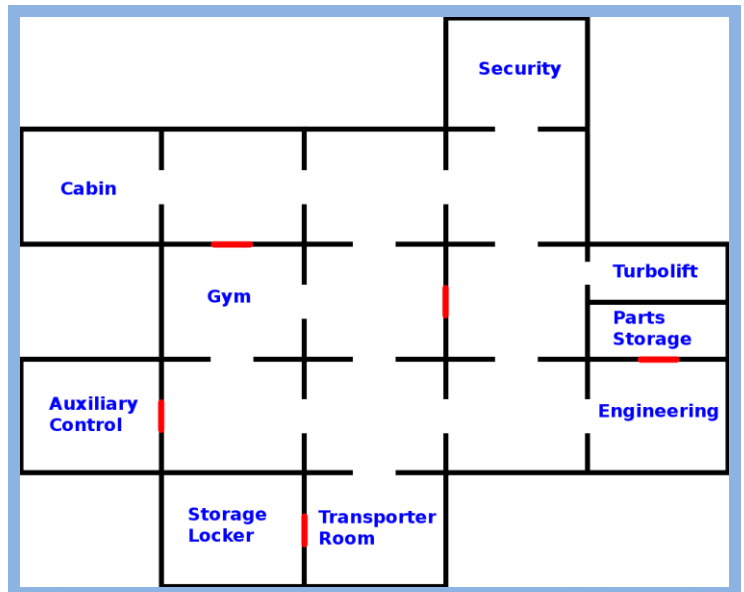

2nd Deck of the Starship Enterprise

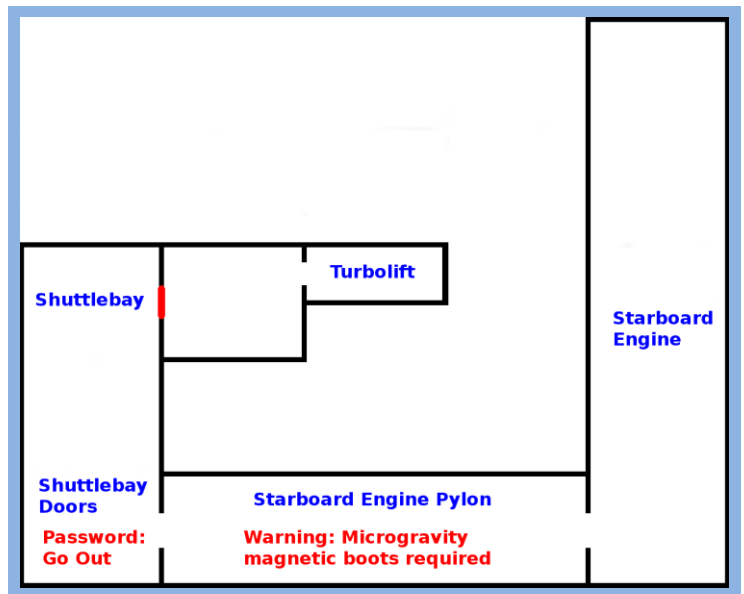

3rd Deck of the Starship Enterprise

Verbs :

- Inventory (this is a stand alone command)
- Go (Ex: Go North, Go South, Go East, Go West, Go Up, Go Down, Go Out, Go Turbolift, Go Ventilator)
- Take, Get (Ex: Get ID)
- Drop, Present, Fix (Replace if on the starboard engine [Replace Valve]) (Ex: Drop Pillow, Drop Valve, Present ID) – these are all really the same verb.
- Look (Ex: Look Around, Look Viewscreen, Look Viewport, Look Panel, Look Readout, Look Uniform, Look Pockets, Look Spacesuit, Look Tricorder, Look Mirror, Look Terminal)
- Open (Ex: Open Locker, Open Armory, Open Door, Open Hatch)
- Shoot, Blast (Ex: Blast Door)

- Put on, Wear (Ex: Put on spacesuit, Put on boots)
- Remove (Ex: Remove boots, Remove spacesuit)
- Push (Ex: Push Button)
- Play (Ex: Play Tape)
- Close (Ex: Close Door)

Nouns:

- North
- South
- East
- West
- Up
- Down
- Out
- Phaser
- Klingat
- Uniforms
- Spacesuit
- SP----- (second spacesuit)
- Boots (Magnetic Boots)
- Flashlight
- Shoes
- Sensor (Flux Sensor)
- Valve (Magnatomic Valve)
- Brandy (Saurian Brandy)
- Pillow
- Tricorder
- Hammer
- Screwdriver (Ordinary Screwdriver or Phillips Screwdriver)
- Wrench (Spanner Wrench)
- Badge or ID (ID Badge)
- Pencil
- Tape (Message Tape)
- Hatch
- Pockets
- Valve (Cracked Valve)
- Mirror
- Viewscreen (Main Viewscreen)
- Engines (Impulse Engines)
- Panel (Uhura's Panel)
- Position (Spock's Position)
- Equipment (Gym Equipment)
- Lockers
- Cells (Detention Cells)
- Button (Engine Firing Button)
- Readout (Flashing Readout)
- Panel (Control Panel)
- Stars
- Crystals (Dilithium Crystals)
- Doors (Open Shuttlebay Doors)
- Locker (Spacesuit Locker)

- Armory
- Door (Closed Door)
- Turbolift
- Terminal (Computer Terminal)
- Ventilator
- Viewport

This program runs on an MC-10, and on a CoCo. The program requires 16k of RAM

How to run the program on a CoCo or an emulator:

- 1) Goto <http://faculty.cbu.ca/jgerrie/Home/jsoft.html>
- 2) Download JGGAMES.zip
- 3) Unzip the files
- 4) Run the emulator (if using an emulator)
- 5) Load "TREKADV.BAS"
- 6) RUN

Watch this video to see how to program works:

[https://www.youtube.com/watch?v=rTPU6F--3\\_4](https://www.youtube.com/watch?v=rTPU6F--3_4)

Loading the application

Initial startup screen

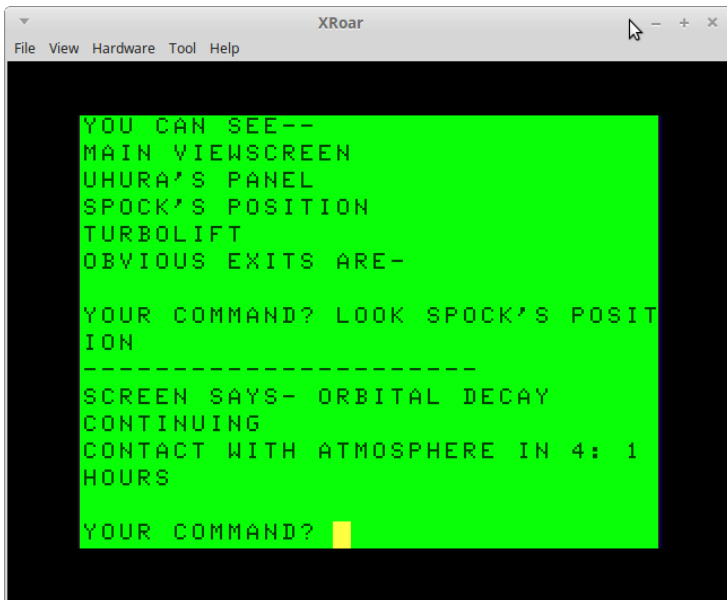

The clock is ticking and you have 4 hours and 1 minute.

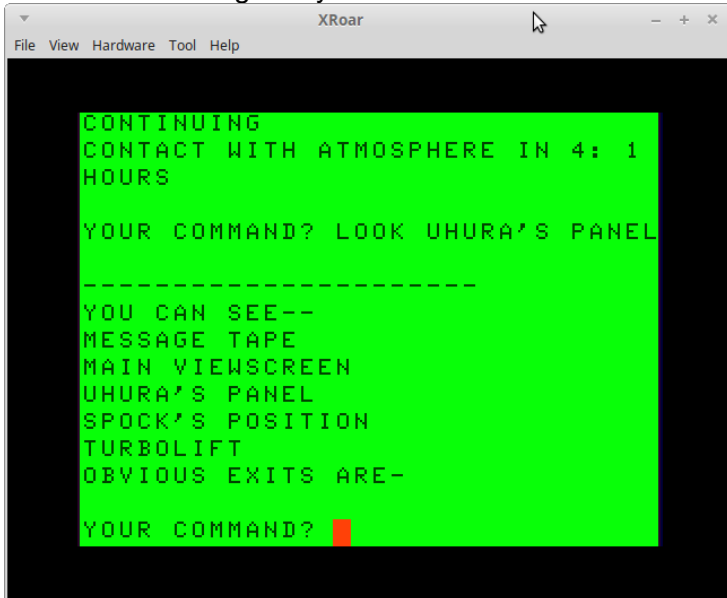

Notice that there is a message tape.



Translation: You are alone & only you can save the ship

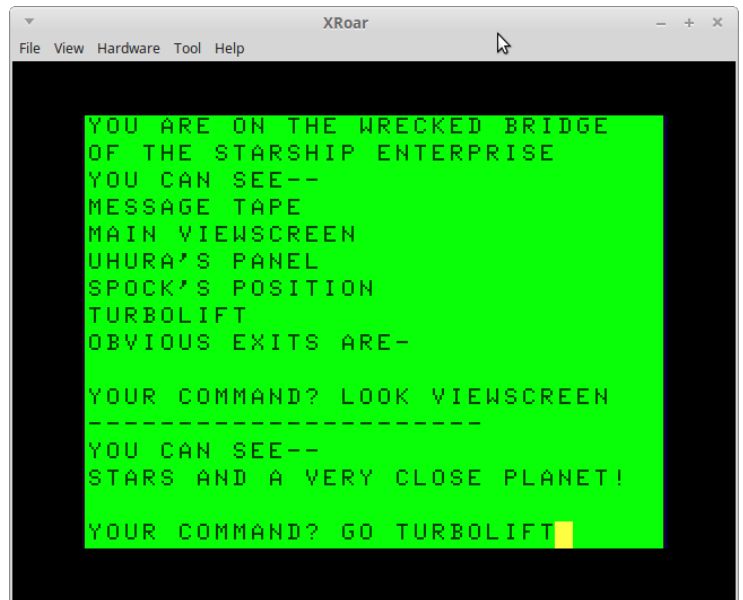

Note the word "very".

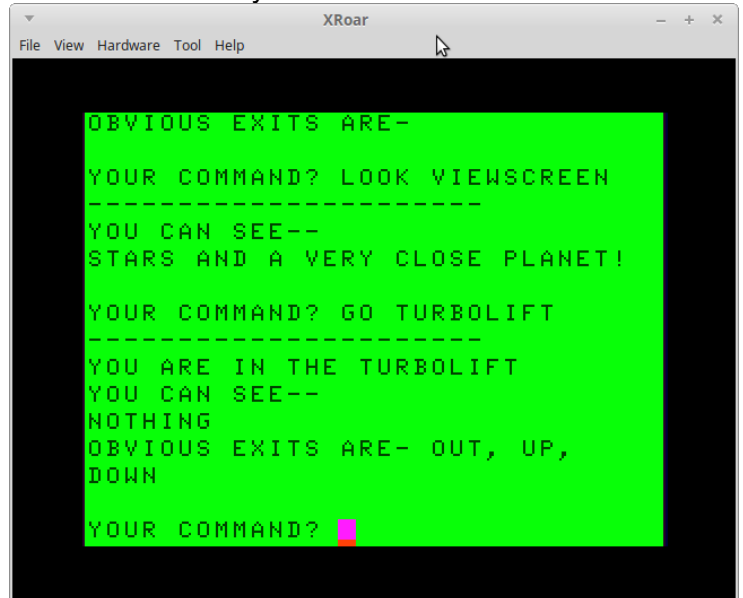

Turbolift commands are Go Down, Go Up, or Go Out.

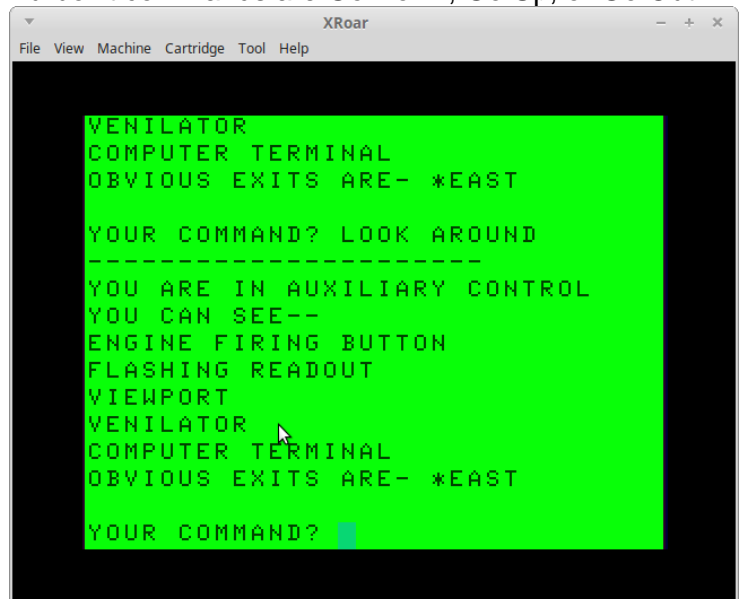

This is where you find your mission.

```

XRoar
File View Machine Cartridge Tool Help

VIEWPORT
VENILATOR
COMPUTER TERMINAL
OBVIOUS EXITS ARE- *EAST

YOUR COMMAND? LOOK READOUT
-----
          WARNING
EXTREMELY FRAGILE
MAGNATOMIC VALVE
ON THE STARBOARD ENGINE IS
CRACKED!
STARTING ENGINES WILL RESULT IN
AN ANTI-MATTER IMPLOSION

YOUR COMMAND?

```

Your mission is to replace the magnatonic valve on the starboard engine and restart the engines.

```

XRoar
File View Machine Cartridge Tool Help

-----
YOU ARE IN AUXILIARY CONTROL
YOU CAN SEE--
ENGINE FIRING BUTTON
FLASHING READOUT
VIEWPORT
VENILATOR
COMPUTER TERMINAL
OBVIOUS EXITS ARE- *EAST

YOUR COMMAND? PU BU
-----
HORRAY!! YOU SAVED THE
ENTERPRISE AT 1:50
OK

```

Once you have replaced the magnatonic valve on the starboard engine, you can safely type "PUSH BUTTON" and the application will print a message and exit. The more time left on the clock, the better. This means I completed the mission in about 132 commands.

Hints (don't worry, I won't give it all away):

The ID Badge is in the Gym.

You can type Go Ventilator. Then move around and look for an opportunity to type Go Down. If you get stuck in Parts Storage then try Go Ventilator.

You may find that before you remove anything from the Cabin that you can drop the Magnatonic Valve in the Cabin without breaking it. If you can figure out why this is true, you will be a step closer to completing the assignment. Also, the rules associated with Drop Magnatonic Valve may change when you are in

microgravity as part of your extravehicular activity (EVA) or spacewalk.

The first spacesuit has just enough oxygen to retrieve the second spacesuit. Then the second spacesuit has enough oxygen to complete the next phase of the mission.

Don't drop the two spacesuits in the same location. The Get Spacesuit command cannot differentiate between the two. Instead place one in the turbolift and one in the corridor outside the turbolift on the 3rd deck.

Don't put the regular screwdriver and the Phillips screwdriver in the same location. The Get Screwdriver command cannot differentiate between the two. Instead, keep them in different locations.

Type "Look Spacesuit".

Type "Get Tricorder" and then "Look Tricorder" just to see what happens.

Type "Blast Mirror" just to see what happens.

Type "Look Mirror" just to see who you are.

Closing the door to the Shuttlebay from the corridor just outside the Shuttlebay will restore the atmosphere. Now it is safe to remove the spacesuit.

This is an example on how to use the ID Badge in engineering: "Present ID", "Open Door", "Get ID", "Look Around", "Go North". Present is another word for Drop, so use the Get command to retrieve the ID Badge.

Every text entry such as Look Around will take 1 minute off the clock. You only have 4 hours (per the simulation, not 4 hours in real time) to complete the mission. This is more than enough time once you know your way around. The program will automatically pause while you take a break. I guess you can say it's turn-based as opposed to real-time. First it's your turn, then it's the computer's turn (to determine cause and effect), and then it is your turn again.

There are many ways to die in the program. You will naturally discover them as you go. Remember the unknown character in the red shirt that dies in the first 2 minutes of many Star Trek episodes (a.k.a. "the expendable cast member")? Well, it is kind of like that. If you crack the spare replacement magnatonic valve, you cannot repair the starboard engine and you are going to die eventually. This may be a good time to see what happens when you prematurely restart the engines, or blast the door to the shuttle bay with the phaser. I mean, you are going to die anyway, so what is the worst that can happen? Remember it's just a simulation. You can always start over. That way you have an unlimited number of lives. No quarter required.

The following video link is a tribute to expendable cast members:

YouTube: Star Trek: Redshirts

<https://www.youtube.com/watch?v=M3cL1Aofy90>

I cannot tell you everything or else you will not enjoy the challenges that await you.

Object Orientated Programming (OOP) and text adventures:

I am learning C++ and OOP. Trek Adventure is written in BASIC, but I wonder if it would have been easier to write it in an OOP language. Imagine that Cabin is a container that holds Closet, and Closet is a container that holds Coat, and Coat is a container that contains Pocket, and Pocket is a container that contains more items, like a Key. Could a container class such as a C++ vector be used to represent/support these concepts? Could I have a vector of pointers to objects that have another vector of pointers to other objects? If you have any ideas along these lines, I would like to talk to you about it. How could I represent the map and movement in OOP? How would I represent the getting and dropping of objects such as Screwdriver? I am not so much thinking of rewriting the program as I am trying to learn how to design using OOP. Is there enough interest in this subject to hold a discussion on it at the 2016 CoCoFEST!? If just 2 or maybe 5 people want to discuss it, we can meet in the lunchroom. If more people want to discuss it, we can schedule a seminar on text adventures and OOP, but I would need to know that you are interested by March.

If you decide to rewrite Trek Adventure, it could use a number of improvements. Commands like Help, Commands, Undo, and Save would be nice. If it could work with text-to-speech and speech-to-text, that would be helpful to the blind. Also, if you could create another adventure that uses the same map plus a new deck for the turbolift, that would be cool. You could start the application and it could ask what adventure you want to load. Now that you have saved the ship, how about getting the crew back on board? Note: "Star Trek" is a registered trademark. Watch the movie "Space Quest" for ideas on how to avoid trademark issues.

Bob Swoger read this article and took on my challenge to improve the program. Bob Swoger had added Trek Adventure to LogiCall some time ago. It is on Disk 80. He made a new version. He added a few commands. In his version, you type "F1", "H", "?", or "HELP" for help; and type "Q" or "QUIT" to quit and return to LogiCall.

Here are some hints on reading the original BASIC source code. A\$ usually represents the verb portion of the text entry, which is just the first 2 letters. Line 86 will convert "GE" to "TA" or Get to Take. Line 120 converts A\$ to a number and stores it in variable F. F=1 if the verb is Go. F=2 if the verb is Take, and so on. B\$ represents the noun or the first 2 letters of the

last word in the text entry. Line 130 converts B\$ to a number and stores it in variable S. S=1 if noun is North, S=2 if noun is South and so on. Line 120 finds the section of code to process the verb. The variable L holds a number that represents your location. The variable O holds a number that represents how many minutes of oxygen your 1<sup>st</sup> space suit has in it. This is as much as I needed to figure out so I did not go any further into figuring out the code. If you figure out more, please share it with me.

### **RGB to HDMI for the CoCo by Barry Nelson**

I have included documentation below describing another method of interfacing a CoCo 3 to an HDMI monitor. This method uses a cable to connect the CoCo 3's video to a SCART to HDMI converter. It has the advantage that you can also quickly switch to composite video to get artifact colors by switching off the +5V signal applied through the 100 ohm resistor to SCART pin 16. I developed this cable and I use it on my CoCo 3. I will NOT be manufacturing it; however, anyone is welcome to build this cable using these instructions. This cable connects to both the RGB output on the CoCo3 and the composite video output.

This document describes how to create a SCART video cable for a Tandy Color Computer 3. SCART is a European video interface standard. In my case I use a SCART to HDMI interface to allow my Color Computer 3 to display on my modern wide screen TV. I wired the CoCo 3's RGB video lines from the connector on the bottom of the computer to the RGB lines in a SCART connector. I connected the audio from the CoCo connector to the left and right audio on the SCART connector. I connected the CoCo 3's composite video to the composite video/sync on the SCART connector and I connected +5V to a 100 ohm resistor connected to the "fast switching" pin on the SCART connector. I then plugged the SCART video connector into my SCART --> HDMI converter, which I plugged into my TV. Voila! Perfect RGB video upscaled to 1080P.

#### **Wiring**

CoCo monitor out pins 1 + 2, ground, to SCART pins 4, 5, 9, 13, 17, and 18

CoCo monitor out pin 3, red video, to SCART pin 15

CoCo monitor out pin 4, green video, to SCART pin 11

CoCo monitor out pin 5, blue video, to SCART pin 7

CoCo monitor out pin 7, audio, to SCART pins 2 and 6

CoCo composite video out center wire to SCART pin 20  
composite/sync

+5V connected to a 100 ohm resistor to SCART pin 16



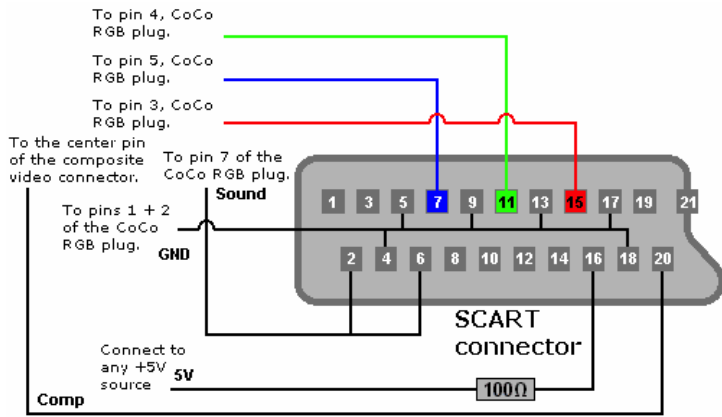

I used this SCART to HDMI converter for \$44.90

Link: HD Video Converter  
<http://tinyurl.com/npkk7nf>



And this SCART connector for \$4.58 plus \$3.06 shipping, \$7.64 total.

Link: Connector  
<http://tinyurl.com/oegwqe7>

I used an old cell phone charger to supply the +5V. You could also get +5V from the CoCo's joystick port.

### Hi-Res Joystick Interface by John Mark Mobley

John Kowalski and Nick Marentes have developed a software driver that uses the standard CoCo 3 joystick ports to make a Hi-Res Joystick Interface. The driver software requires no additional hardware. It uses software tricks to get greater resolution. Standard resolution is 6-bit or a count of 0 to 63. The new driver software works to allow a standard CoCo analog mouse to position to anywhere on the screen. It now has a resolution of 15-bits. It has been tested with a 320x200 screen and it works!

To learn more, read the link below.

Link:  
<http://tinyurl.com/gkr58af>

Now that we have this driver software, we need people to include it in their programs and make use of it.

Perhaps someone can start a contest to get people to get their creative juices going.

So the CoCo 3 has had this capability all along, but we are just now proving it can be done. What else is yet to be discovered?

### Neutroid 2.015 by John Mark Mobley

Nick Marentes has updated Neutroid 2 to Neutroid 2.015 and now it runs not only on the CoCo 1 and CoCo 2, but also now runs on the CoCo 3, using its semigraphics modes. Nick has made the gameplay easier and improved the screens. He also changed the control mode from keyboard to joystick. Nick says he has also improved the documentation.

Link: Neutroid2015.html  
<http://tinyurl.com/hvufn4d>

Link: YouTube Video  
<http://tinyurl.com/zvhw45q>

Link: Neutoid Instructions.pdf  
<http://tinyurl.com/gsmvwhh>

### The CoCo Crew Podcast by John Mark Mobley

CoCo Crew Podcast has produced 7 shows now. If you have any trouble getting it to play, then write John or Neil and tell them what system you would like to listen to it on. And then ask what playback software is available for that system.



Link:  
<http://cococrew.org/>

John Linville Email:  
[john@cococrew.org](mailto:john@cococrew.org)

Neil Blanchard Email:  
[neal@cococrew.org](mailto:neal@cococrew.org)

YouTube Video: How to listen to a Podcast:  
<https://www.youtube.com/watch?v=8IPV2oSz8m4>

For my Android Smart Phone I use an app called BeyondPod.

### Xmas Rush by John Linville

This is an announcement of the availability of a new Christmas-themed game for the CoCo and Dragon, Xmas Rush. The object of the game is to seize the last evergreen tree in the forest and then to escape the evil snowmen guarding it -- sounds silly, but it is fun! :-)

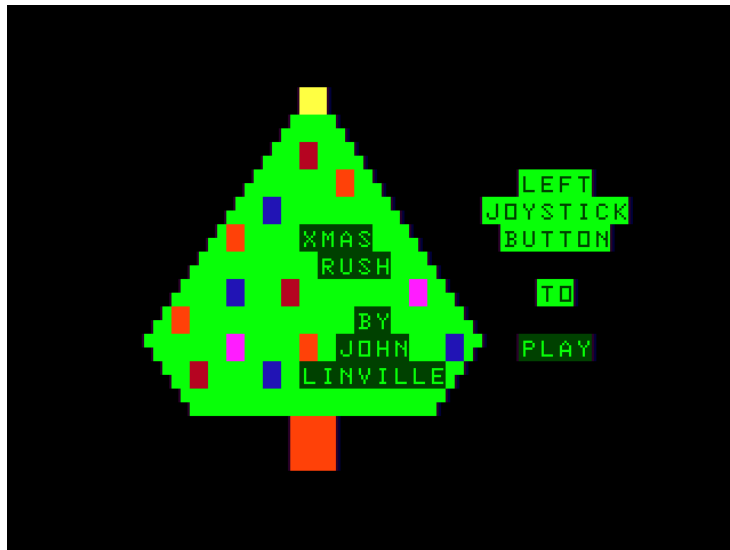

Introduction Screen

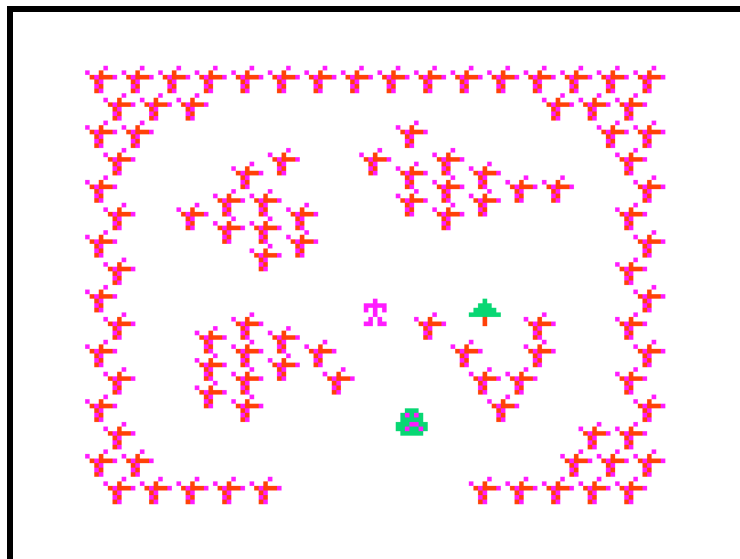

Action Screen

A demo video of the game is available here:  
<https://www.youtube.com/watch?v=EcqZKGqq7dc>

Some screenshots and file downloads are available here:  
<http://www.tuxdriver.com/download/xmasrush/>

Please give the game a try during the time-off that most of us have around the end-of-the-year holidays! I hope you will try it and enjoy it!

Carpe arbores!

See you next year: April 23 & 24, 2016  
HERON POINT CONVENTION CENTER  
645 West North Avenue  
Lombard, IL 60148

645 Building on the lower level  
Saturday Setup Time 7 am,  
Saturday FEST Time 9 am to 5 pm,  
Saturday Supper Time 5 pm to 7 pm,  
Saturday Evening Social Time 7 pm to 11:30 pm,  
Sunday Worship Service Time 8 am,  
Sunday FEST Time 9 am to 3 pm,  
Sunday Close-Up Time 3 pm to 5 pm

### Calendar of Events

by

John Mark Mobley and Salvador Garcia

Glenside Color Computer Club, Inc. Business Meetings

Thursday, January 14, 2016

Thursday, February 11, 2016

Thursday, March, 10, 2016

7:00 PM to 10:00 PM CST

Schaumburg Public Library

130 South Roselle Road

Schaumburg, IL, USA

Skype access available via: john.mark.mobley

Saturday January 23, 2016

Portland Retro Gaming Expo /

NorthWest Classic Gaming Enthusiasts Swap Meet

Portland, Oregon, USA

Link: <http://www.retrogamingexpo.com/>

VCF Southeast 4.0 - April 2 & 3 2016, Roswell, GA

Friday, Saturday, & Sunday April 8-10, 2016

Midwest Gaming Classic

Brookfield, Wisconsin, USA

Link: <http://www.midwestgamingclassic.com/>

Friday, Saturday, & Sunday April 15-17, 2016

Vintage Computer Festival East (VCF East)

Wall, New Jersey, USA

Link: <http://www.midatlanticretro.org/>

Saturday and Sunday April 23-24, 2016

The 25<sup>th</sup> Annual "Last" Chicago CoCoFEST!

Lombard, Illinois, USA

Link: <http://www.glensideccc.com/cocofest/index.shtml>

Be sure to visit our Website to see up to date  
information on upcoming events. <http://glensideccc.com>

## The 25th Annual "Last" Chicago CoCoFEST!



*25<sup>th</sup> Anniversary*

2016 CoCoFEST!  
Proudly Presented By  
The Glenside Color Computer Club  
Fairfield Inn, Lombard, Illinois

Here are the 5 "W's"

**WHO?** 1) Glenside Color Computer Club, Inc.  
PRESENTS

**WHAT?** 2) The 25th Annual "Last" Chicago CoCoFEST!

**WHEN?** 3) April 23 & 24, 2016

(Sat. 9 am-5 pm; Sun. 9 am-3 pm)

**WHERE?** 4) Fairfield Inn & Suites Lombard

645 West North Avenue

Lombard, IL 60148

(Near the intersection of IL-355 and North Avenue)

**(Same location as 2015!)**

**Overnight room rate:**

**\$84.00 plus 11% tax (\$93.24 Total)**

**Call 1-630-629-1500 for reservations.**

**You must ask for the Glenside "CoCoFEST!" rate.**

**>>> YOU MUST REGISTER UNDER "CoCoFEST!" <<<**

**>>> TO GET THIS RATE <<<**

**WHY?** 5)

**A. To provide vendor support to the CoCo  
Community**

**B. To provide Community support for our CoCo  
Vendors**

**C. To provide educational support to new users.**

**D. TO HAVE AN OUTRAGEOUSLY GOOD TIME!!!**

**And now, the "H" word.**

**HOW MUCH? All Attendees - General Admission**

**Both days: \$10.00 1st - \$5.00 2nd & more**

**Sunday Only: \$5.00 1st - \$5.00 2nd & more**

**\*\*\*\*\* Children 12 and under - FREE \*\*\*\*\***

For further information, general or exhibitor, contact:

**Tony Podraza, GCCCI Robert Swoger, GCCCI**

**847-428-3576, VOICE 224-236-5194, VOICE**

**[tonypodraza@gmail.com](mailto:tonypodraza@gmail.com) [rswoger@aol.com](mailto:rswoger@aol.com)**

**Please note the new starting times, 9 AM, not 10 AM.**