

HP

PCL/PJL

Reference

**PCL 5
Printer Language
Technical Reference
Manual**

Part II

17 An Introduction to HP-GL/2 Vector Graphics

The PCL 5 printer provides the ability to print vector graphics using the HP-GL/2 graphics language. HP-GL/2 graphics may be created within application software, or imported from existing applications. For various types of images (many technical drawings and business graphics, for example), it is advantageous to use vector graphics instead of raster graphics. The advantages include faster I/O transfer of large images and smaller disk storage requirements.

Note

As a guideline, use raster graphics for small, complex images, or those images that cannot be accomplished with HP-GL/2 (such as scanned photographs). Use HP-GL/2 for images that would involve a large amount of I/O data transfer if printed using raster graphics, or for drawings that are already in HP-GL/2 format. If the image is easier to describe using vectors instead of raster lines, the image usually prints faster using HP-GL/2.

Printing with HP-GL/2 requires leaving the PCL printer language mode and entering HP-GL/2 mode. Switching between modes involves only a few commands, and software applications easily switch between the two modes as needed.

Learning HP-GL/2

Read through this chapter and Chapter 18 for a general overview of the HP-GL/2 language and its relationship to the PCL printer language. Then, flip through the other HP-GL/2 chapters until you see an example that interests you or fits your objective. Read through the examples and try printing them using your choice of programming languages. If you need help converting the generic commands shown in the examples to a programming language, see “Using HP-GL/2 with Programming Languages” later in this chapter.

As you see unfamiliar commands, find the page number of the command description in the index and read about the command. Think of an application that you would like to program and then look for an example that uses some of the elements you desire. After trying some examples and seeing how the commands interact, you should be well on your way to learning the HP-GL/2 language.

This chapter describes the interaction between the PCL printer language and HP-GL/2 modes and introduces the following topics:

- HP-GL/2 Commands and Syntax
- Using HP-GL/2 with Programming Languages
- The HP-GL/2 Coordinate System
- HP-GL/2 and PCL Orientation Interactions
- The Vector Graphics Limits
- Units of Measure
- Pen Status and Location
- Defining the Image Area (PCL Picture Frame)
- Scaling
- Automatically Adjusting Image Size
- Absolute and Relative Pen Movement

Chapter 18 covers more HP-GL/2 fundamentals, and Chapters 19 through 23 discuss HP-GL/2 commands and their syntax.

HP-GL/2 Commands and Syntax

There are two classes of commands used to print vector graphics: PCL printer language commands and HP-GL/2 commands. As the name implies, the *PCL printer language commands* are used when in the PCL printer language mode. They define the area on the page where HP-GL/2 graphics are printed and provide a means to enter HP-GL/2 mode. The *HP-GL/2 commands* are used within HP-GL/2 mode. They define the image that is printed, and allow you to return to the PCL printer language mode. The HP-GL/2 language has its own syntax, and each command is listed in this section of the manual.

The vector graphics commands have been grouped into functional categories. The categories are designated as shown in Table 17-1 through . Each of the command categories is discussed in its own chapter, beginning with Chapter 19, *The Configuration and Status Group*.

Table 17-1 The HP-GL/2 Commands by Group (1 of 5)

CONFIGURATION GROUP	
CO	Comment
DF	Default Values
IN	Initialize
IP	Input P1 and P2
IR	Input Relative P1 and P2
IW	Input Window
PG ¹	Advance Page
RO	Rotate Coordinate System
RP ¹	Replot
SC	Scale

1. Ignored by HP LaserJet printers.

Table 17-2 The HP-GL/2 Commands by Group (2 of 5)

VECTOR GROUP	
AA	Arc Absolute
AR	Arc Relative
AT	Absolute Arc Three Point
BR	Bezier Relative
BZ	Bezier Absolute
CI	Circle
PA	Plot Absolute
PD	Pen Down
PE	Polyline Encoded
PR	Plot Relative
PU	Pen Up
RT	Relative Arc Three Point

Table 17-3 The HP-GL/2 Commands by Group (3 of 5)

POLYGON GROUP	
EA	Edge Rectangle Absolute
EP	Edge Polygon
ER	Edge Rectangle Relative
EW	Edge Wedge
FP	Fill Polygon
PM	Polygon Mode
RA	Fill Rectangle Absolute
RR	Fill Rectangle Relative
WG	Fill Wedge

Table 17-4 The HP-GL/2 Commands by Group (4 of 5)

CHARACTER GROUP	
AD	Alternate Font Definition
CF	Character Fill Mode
CP	Character Plot
DI	Absolute Direction
DR	Relative Direction
DT	Define Label Terminator
DV	Define Variable Text Path
ES	Extra Space
FI ¹	Select Primary Font
FN ¹	Select Secondary Font
LB	Label
LO	Label Origin
SA	Select Alternate Font
SB	Scalable or Bitmap Fonts
SD	Standard Font Definition
SI	Absolute Character Size
SL	Character Slant
SR	Relative Character Size
SS	Select Standard font
TD	Transparent Data

1. These commands are part of HP-GL/2's Dual Context Extensions.

Table 17-5 The HP-GL/2 Commands by Group (5 of 5)

LINE AND FILL ATTRIBUTES GROUP	
AC	Anchor Corner
FT	Fill Type
LA	Line Attributes
LT	Line Type
PW	Pen Width
RF	Raster Fill Definition
SM	Symbol Mode
SP	Select Pen
SV ¹	Screened Vectors
TR ¹	Transparency Mode
UL	User-defined Line Type
WU	Pen Width Unit Selection

1. These commands are part of the Palette Extensions to HP-GL/2.

As shown in the tables above, each HP-GL/2 command is a two-letter mnemonic code designed to remind you of its function. For example, IN is the Initialize command, SP is the Select Pen command, and CI is the Circle command. Parameters are used with certain HP-GL/2 commands to tell the printer to complete the command in a particular way.

Understanding HP-GL/2 Syntax

HP-GL/2 commands have four components: a mnemonic, parameter(s), separator(s), and a terminator. Refer to the following illustration of a typical HP-GL/2 command and the description of its components.

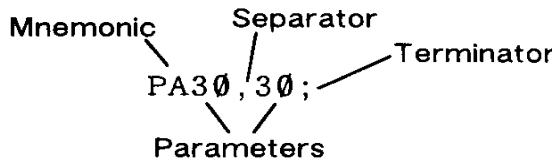

Figure 17-1 Typical HP-GL/2 Command

- **Mnemonic**--The two-letter mnemonic reminds you of the command's function. The mnemonic can be uppercase or lowercase.
- **Parameter(s)**--Some commands have no parameters; for those commands which have them, parameters can be either required or optional (as indicated in the description of that command).
- **Separator(s)**--When you use parameters, you must separate them with a comma or space, or in the case of a numeric parameter, with a + or - sign. (Commas are recommended because some computers eliminate spaces, especially when sending variables.)
- **Terminator**--All commands require a terminator. Most HP-GL/2 commands are terminated by a semicolon or the first letter of the next mnemonic, a white space, or a tab (exceptions: LB uses a user-defined terminator; PE cannot use the first letter of the next mnemonic). The last command prior to exiting HP-GL/2 mode *must* be terminated with a semicolon.

The following illustration shows the flexibility of the syntax. Each variation of the two-command sequence is permissible; however, the method shown on the left is recommended in most instances. The recommended method uses the first letter of the next mnemonic to terminate commands, uses no space between the mnemonic and its parameters, and separates parameters with a comma. (For clarity, examples in this HP-GL/2 section of the manual use semicolons as terminators, as shown in the middle example below.)

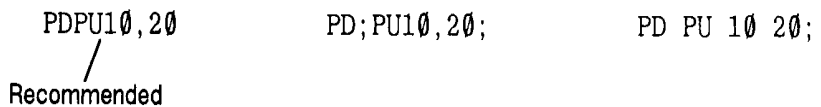

Figure 17-2 Illustration of Syntax Flexibility

The next section explains how the syntax of individual commands is presented.

Notations Used to Express Syntax

The following describes the notations used in the syntax section of each command description:

Mnemonic

For readability, the mnemonic is shown in uppercase and separated from the parameters and/or terminator.

parameters

Parameters are shown in italic.

[]

Parameters in square brackets are optional.

[param1,param2...[,param1,param2]]

These optional parameters must be paired.

params...params

These parameters may be given the number of times specified in the command description.

text...text

This parameter indicates that you can type in a range of ASCII characters, such as in the Label (LB) command.

(...)

Indicates that you can use a range of the previous parameter; however, all X coordinates must have a corresponding Y coordinate.

Note

Remember that while X,Y coordinates are shown in parentheses in text [for example (3,4) or (0,0)], the parentheses are not part of the syntax. Do not enter these parentheses in your commands.

;

iCommand terminator. In most HP-GL/2 commands, a semicolon is optional, and is shown in parentheses in most command syntax.

Notes

Three exceptions to the optional use of the semicolon as a command terminator occur in the following commands: Polyline Encoded (PE), Label (LB), and Comment (CO).

PE must be terminated by a semicolon. LB is terminated by the non-printing end-of-text character (ETX - decimal 3), or a user-defined character. The comment string of the CO command must be delimited by double quotes.

A semicolon terminator is **always required** following the last command prior to leaving HP-GL/2 mode.

,

A comma is always shown as the separator between parameters. A space, +, or - is also valid (although not preferred). (A + or - is a valid separator only for numeric parameters.)

Omitting Optional Parameters

Some commands have optional parameters that take on default values if they are omitted. When you omit a parameter, you must omit all subsequent parameters in the same command (the Define Label Terminator (DT) command is an exception).

For example, the Line Type (LT) command has three optional parameters: type, pattern length, and mode. The following command shows all three being used (*type = 6, pattern length = 25, mode = 1*).

LT6,25,1

If you omit the second parameter you must also omit the third parameter, as shown below:

LT6

The printer uses the most recently specified pattern length and mode. If you have not specified a length or mode since sending a Default Values (DF) or Initialize (IN) command, the printer uses the parameter's defaults.

For example, if you send the following command (omitting the second parameter), the printer interprets the "1" as the second parameter:

LT6,1

Parameter Formats

You must give parameters in the format (type of units) required by each HP-GL/2 command. The required format is stated in the parameter table of each command's description, and is described as follows.

- 1 *Integer*—An integer from $-1,073,741,823 (-2^{30} + 1)$ to $1,073,741,823 (2^{30} - 1)$. The printer automatically rounds fractional parameters to the nearest integer within the range. Sending a number outside the parameter range may produce unexpected results.
- 2 *Clamped Integer*—An integer from $-32,768 (-2^{15})$ to $32,767 (2^{15} - 1)$. The printer automatically rounds fractional parameters to the nearest integer. Sending a number outside this range does not cause an error, but the number is "clamped" to the limits of the range. For example, when parsing a clamped integer, the printer treats all numbers above 32,767 as 32,767.

Certain commands have parameters which are restricted to a smaller range. These ranges are listed in the parameter tables for each command. Sending a number outside the reduced parameter range may produce unexpected results.

- 3 *Real*—A number with an integer portion from $-1,073,741,823 (-2^{30} + 1)$ to $1,073,741,823 (2^{30} - 1)$. You are assured of at least 6 significant digits (including integer and fractional portion). You may omit the decimal point when no decimal fraction is specified. Sending a number outside the parameter range may produce unexpected results.

- 4 *Clamped Real*—A number with an integer portion from $-32,768$ to $32,767$; you are assured of at least 6 significant digits (including integer and fractional portion). You may omit the decimal point when no decimal fraction is specified. Sending a number outside this range does not cause an error, but the number is “clamped” to the limits of the range. For example, the printer treats all numbers above $32,767$ as $32,767$.

Certain commands have parameters which are restricted to a smaller range. These ranges are listed in the parameter tables for each command. Sending a number outside the reduced parameter range may produce unexpected results.

- 5 *Label*—Any sequence of characters. In the HP-GL/2 language, text is described using the term “label.” Refer to the Label (LB) command in Chapter 23 for a complete description.

Note

Numbers within the above-mentioned ranges do not cause errors; however, the range may exceed the printer’s physical printing area. Numbers that move the pen position outside the *effective window* result in image clipping. This topic is discussed in more detail later in this chapter under “The Vector Graphics Limits.”

When you see the term “current units” in a parameter table, the unit system of that parameter depends on whether scaling is on or off. When scaling is on, the units are user-units; when scaling is off, the units are plotter units (described under “Units of Measure” later in this chapter).

Notes

The printer cannot use exponential format numbers (for example, $6.03E8$). If you are using a computer or language that uses the exponential format, you must use integer variables or a formatting technique to output fixed-point real numbers.

Parameter values less than the range maximum are passed by the parser; these values may subsequently be unscaled into resolution units (e.g. 7200 units-per-inch) that exceed the device-dependent internally representable number range. If this occurs, the device enters a LOST mode; all relative drawing commands are ignored until a command is received which specifies an absolute move to a point within the internally representable number range.

Notes

When LOST mode is entered, the pen is raised and the following commands are ignored: AA, AR, AT, CI, CP, EA, ER, EW, LB, PE, PM, PR, RA, RR, RT, and WG.

The commands allowed in LOST mode are: AC, AD, CF, CO, DF, DI, DR, DT, DV, ES, FT, IN, IP, IR, IW, LA, LO, LT, PA, PD, PG, PU, PW, RF, RO, RP, SA, SB, SC, SD, SI, SL, SM, SP, SR, SS, TD, UL, WU, and the PM1/PM2 forms of PM.

The commands IN, PG, RP, and PA, with in-range parameters, clear LOST mode, PD and PU in absolute plotting mode, with in-range parameters, also clear LOST mode. When PD clears LOST mode, a line is drawn from the last valid current position to the first point in the PD parameter sequence. If PA clears LOST mode, the pen will not go down until a PD command is received.

Using HP-GL/2 With Programming Languages

The HP-GL/2 examples included in this manual are given in a “generic” format (they show the commands required to perform a specific function but usually do not use a specific programming language). In most cases, the commands are accompanied by a brief description of the command being used.

To see how HP-GL/2 commands are used in BASIC and the C programming language, see the following examples.

Example: BASIC

This example uses BASIC to print three lines forming a simple triangle (shown below).

```
10 LPRINT CHR$(27);"E"; :REM Reset the printer
20 LPRINT CHR$(27);"%0B"; :REM Enter HP-GL/2 Mode
30 LPRINT "IN"; :REM Initialize HP-GL/2 Mode
40 LPRINT "SP1PA10,10"; :REM Select Pen & move to 10,10
50 LPRINT "PD2500,10,10,1500,10,10;"; :REM Pen down & draw
60 LPRINT CHR$(27);"%0A"; :REM Enter PCL Mode
70 LPRINT CHR$(27);"E"; :REM Reset to end job/eject page
```

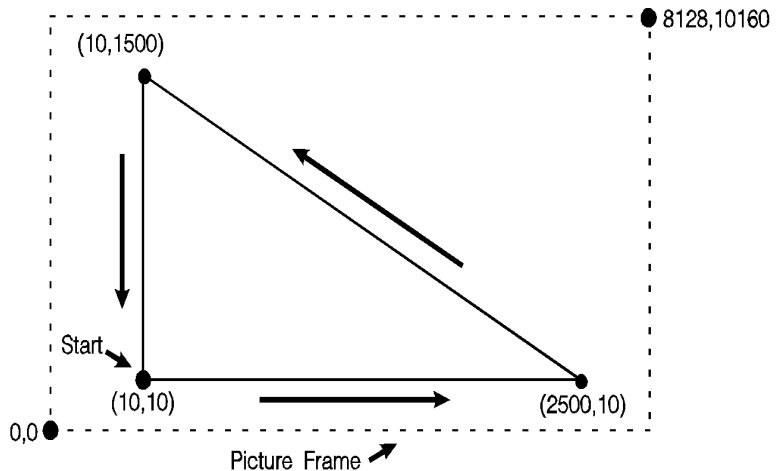

Figure 17-3

Example:C Programming Language

This example uses the C programming language to print the same three lines shown on the previous page.

Table 17-6

```
#include <stdio.h>

main()
{
    FILE *prn;
    prn = fopen("PRN", "wb");           /* open the printer */
    fprintf(prn, "033E");              /* EC E to reset printer */
    fprintf(prn, "033%%>0B");          /* Enter HP-GL/2 */
    fprintf(prn, "IN");                 /* Initialize HP-GL/2 Mode */
    fprintf(prn, "SP1PA10,10");        /* Select pen 1 & move to 10,10 */
    fprintf(prn, "PD2500,10,10,1500,10,10;"); /* Pen down & draw */
    fprintf(prn, "033%%0A");           /* enter PCL at previous CAP */
    fprintf(prn, "033E");              /* Reset to end job/eject page */
}
```

The HP-GL/2 Coordinate System

Both PCL and HP-GL/2 use a Cartesian Coordinate System. The Cartesian coordinate system is a grid formed by two perpendicular axes, usually called the X-axis and Y-axis (refer to Figure 17-4). The intersection of the axes is called the origin of the system and has a location of (0,0). The default HP-GL/2 coordinate system is different than the PCL coordinate system; +Y is down in PCL and up in HP-GL/2. In addition, the default origin is at the lower left in HP-GL/2 and at the upper left in PCL.

Note

The HP-GL/2 coordinate system can be set up to match the PCL coordinate system. See the example entitled “Adapting the HP-GL/2 Coordinate System to Match the PCL System” in Chapter 19.

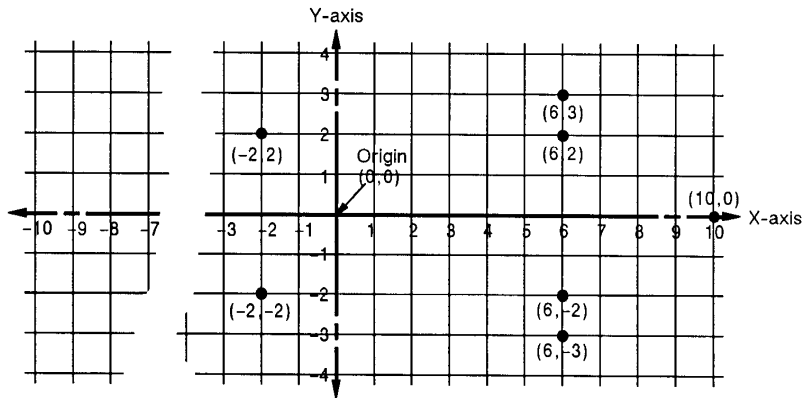

Figure 17-4 The HP-GL/2 Coordinate System

To locate any point on the grid (the printing area within the PCL Picture Frame), move from the origin a number of units along the X-axis, then move a number of units parallel to the Y-axis. The number of units you move matches a coordinate location. Each point is designated by the combination of its X-coordinate and Y-coordinate, known as an X,Y coordinate pair. In , positive X values are plotted to the right of the origin, and positive Y values are plotted above the origin.

Study Figure 17-4 to locate these points: (0,0); (-2,2); (6,2); (6,3); (10,0); (6,-3); (6,-2); (-2,-2); (0,0). Draw a straight line between each point in the order listed. (You should have drawn an arrow.) This is a simple demonstration of defining a vector image when in HP-GL/2 mode.

Note

To specify a point when programming an application, you must always give a complete X,Y coordinate pair; the X coordinate is first and the Y coordinate second. This manual shows coordinate pairs in parentheses (X,Y) for clarity. Do not use parentheses in your command sequence.

Using the default HP-GL/2 coordinate system, the origin is in the lower left corner of the PCL Picture Frame, as shown in Figure 17-5. Using the IP or IR commands, you can move the origin to other locations. Then, using the SC command, you can define practically any unit coordinate system. (This process is discussed in more detail later in this chapter under “Scaling,” and also in Chapter 19.)

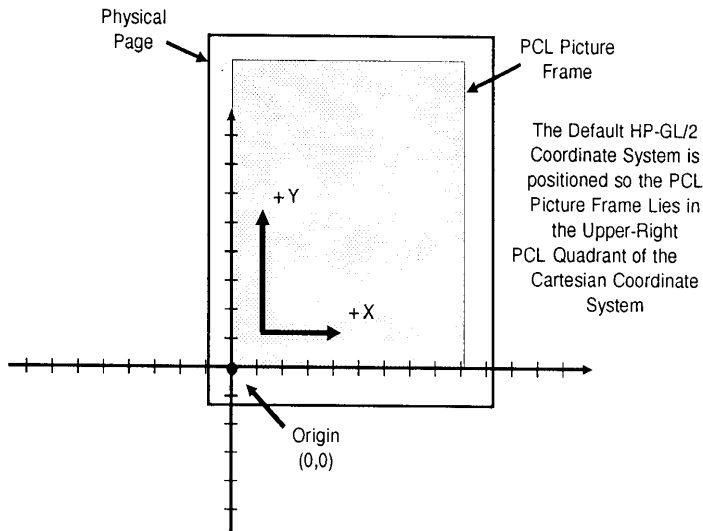

Figure 17-5 The Default HP-GL/2 Coordinate System

HP-GL/2 & PCL Orientation Interactions

The relationship between the orientation of the HP-GL/2 coordinate system and the PCL coordinate system is important. Figure 17-6 illustrates this relationship for the default HP-GL/2 orientation (RO 0) and the PCL logical page orientation. As shown in the illustration, in the default HP-GL/2 orientation, the origin of the HP-GL/2 coordinate system defaults to the lower-left corner of the PCL Picture Frame. (HP-GL/2 and PCL X-coordinates increase in the same direction, but the Y-coordinates increase in opposite directions.) Notice that a change in the PCL logical page orientation changes the orientation of the PCL coordinate system and the HP-GL/2 coordinate system.

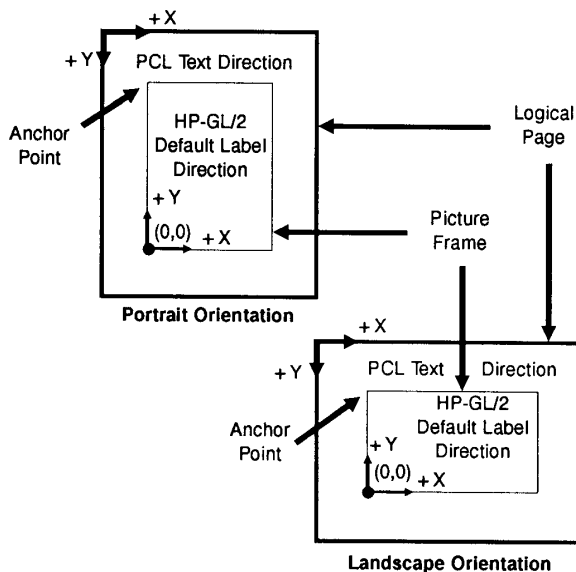

Figure 17-6 Orientation Interactions Between PCL and HP-GL/2

The relationship between the coordinate systems can be changed using the HP-GL/2 Rotate (RO) command. Rotations specified by the RO command are relative to the default HP-GL/2 orientation (which matches the PCL orientation). Figure 17-7 shows how the RO command modifies the default HP-GL/2 orientation.

Note

A change in PCL print direction has no effect on the HP-GL/2 orientation, the physical position of the picture frame, or the picture frame anchor point.

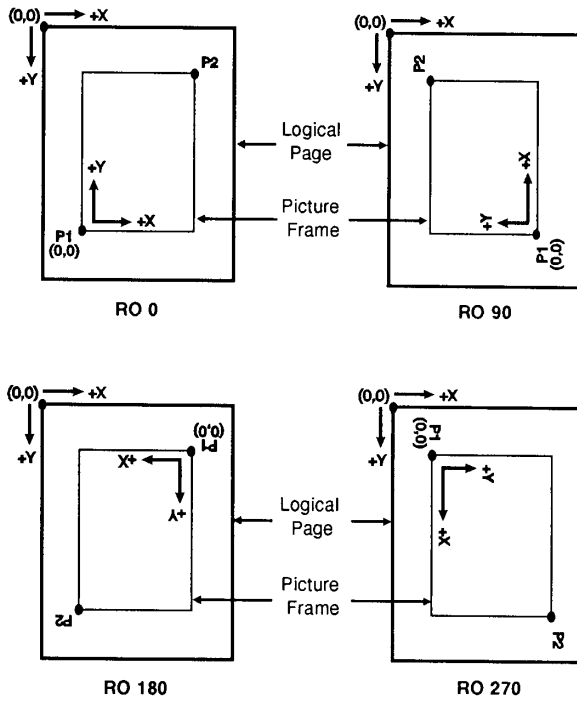

Figure 17-7 Modifying HP-GL/2 Orientation on a Portrait Page

The Vector Graphics Limits

The area on the page where a vector graphics image can be printed is determined by the intersection of the following four boundaries:

- Hard-clip Limits
- Soft-clip Window
- PCL Logical Page
- PCL Picture Frame

The *hard-clip limit* refers to the boundaries resulting from the physical limits of the printer (in PCL mode, this is referred to as the *printable area*). The *soft-clip limit* refers to the area defined using the HP-GL/2 *Input Window (IW)* command. The intersection of all these areas is the *effective window*. An HP-GL/2 graphic appears on the page only if it falls within the effective window.

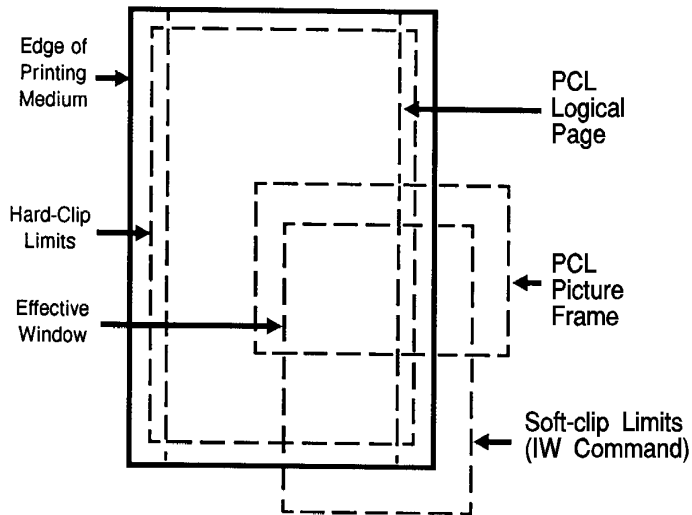

Figure 17-8 The Effective Window

Note

For more information on the PCL coordinate system and the PCL 5 printer's printable limits, see Chapter 2.

HP-GL/2 Units of Measure

In HP-GL/2 mode, you can measure along the X,Y axes and express coordinates using two types of units: *plotter units* and *user-units*.

Plotter Units

One *plotter unit* equals 0.025 mm. When specifying distances in plotter units, the printer converts the number of plotter units to equivalent dot coordinates before printing. Under default conditions, the printer uses plotter units.

The following table lists equivalent measurements for plotter units.

Table 17-7

PlotterUnits	EquivalentValue
1 plu =	0.025 mm (\approx 0.00098 in.)
40 plu =	1 mm
1016 plu =	1 in.
3.39 plu =	1 dot @ 300 dpi

User-units

The size of units along the X and Y axes may be redefined using the Scale (SC) command. User-units allow you to customize the coordinate system to represent any value. For example, you could plot the moon cycle for the year by dividing the X-axis into 31 units for days of the month and the Y-axis into 12 units for months of the year. To mark a point on December 25, you would give the coordinate (25,12) rather than calculating the exact location in plotter units.

Before printing, the printer internally converts user-units to dot locations.

Pen Status and Location

Since printing vector graphics has traditionally been performed with plotters, the terms *pen* and *pen position* are used to describe the HP-GL/2 cursor, the current active position (CAP) when in HP-GL/2 mode. Like a physical pen, this imaginary pen must be selected if you want to draw images. Commands such as Pen Up (PU) or Pen Down (PD), and phrases such as “current pen position” or “moving the pen” apply to the imaginary pen just as they would a physical pen on a plotter.

Pen Status

Pen status refers to whether the “pen” is up or down. Use the Pen Up (PU) command with X,Y coordinates to move the pen to the desired printing location without drawing a line. Use the Pen Down (PD) command with X,Y coordinates to lower the pen and begin drawing from the current location to the first specified X,Y coordinate.

Upon entering HP-GL/2 mode for the first time following a reset (E_{CE}) command, no pen has been selected and the pen is up. *This means that no lines are drawn when HP-GL commands are given until a pen is selected.* This can be done using the Select Pen (SP) command.

Most drawing commands require that the pen be lowered to produce marks on the page. Once lowered with a Pen Down (PD) command, the pen remains down for subsequent HP-GL/2 printing commands until a Pen Up (PU) or Initialize (IN) command is issued. The pen remains selected until a new SP command is received. You must be aware of the pen’s up/down status to avoid drawing stray lines between parts of your picture.

Note

Upon entry into HP-GL/2 mode, a good programming practice is to select a pen and command a pen-up move to the initial starting position. This ensures that a pen is selected and is in the proper position to begin drawing.

Every time you use a PU or PD command, the printer updates the pen up/down status. The following table shows the commands that include an automatic PD command as part of their function. After performing their complete function, they return the pen to its previous up/down state.

Table 17-8 Commands That Include an Automatic Pen Down

Command		Group
CI	Circle	<i>The Vector Group</i>
EA	Edge Rectangle Absolute	<i>The Polygon Group</i>
EP	Edge Polygon	
ER	Edge Rectangle Relative	
EW	Edge Wedge	
FP	Fill Polygon	
RA	Fill Rectangle Absolute	
RR	Fill Rectangle Relative	
WG	Fill Wedge	
LB	Label	<i>The Character Group</i>
SM	Symbol Mode	<i>The Line and Fill Attributes Group</i>

Notes

Whenever the printer receives a Pen Down command, it produces a dot at the current pen location. If the pen is already down when the printer receives a command with an automatic Pen Down, the unnecessary dot can mar your final output. For best results, include a Pen Up (PU) command before any command with an automatic Pen Down.

Only the portion of the pen falling within the effective window is printed. The pen is centered on a line between the beginning and end points, with half of the pen width falling on either side of this line.

The definition of each command tells you whether it has an automatic pen down. If you find that part of your image is not drawn, make sure your command sequence uses the PD command before the affected commands.

Pen Location

Pen location refers to the X,Y coordinates of the current active position (CAP — the point at which the next HP-GL/2 command begins). Most commands, when completed, update the pen location. The next command then begins at that location. Some commands do not update the current pen location. The definition of each command tells you whether the current pen location is updated or restored. Use the Pen Up (PU) command with the desired X,Y coordinates to lift the pen and move it to a new location.

The Default Values (DF) command does not reset the current pen location; the Initialize (IN) command moves it to the lower-left corner of the PCL Picture Frame. You should specify your beginning pen location for each HP-GL/2 drawing.

Scaling

When you *scale* a drawing, you define your own units of measurement instead of using plotter units; the printer converts your units (*user-units*) to dot positions for placing the image on the page. *Scaling* allows control of the printer using units that are easy for you to work with.

For example, you can scale your drawing to divide the drawing area into 100 squares. As you plan the drawing, you can think in terms of 100 squares rather than plotter units. Here is another example of scaling: since 400 plotter units equals 1 centimeter, you can establish this scale to print in user-units equal to 1 centimeter each.

Scaling begins with the scaling points, P1 and P2. P1 and P2 act as two points marking opposite corners of a rectangle. You can make this rectangle any size and place it anywhere in relation to the origin, depending on the plotter unit coordinates you specify for P1 and P2. (P1 and P2 default to the lower left and upper right corners of the picture frame, respectively, but you can change their locations using the Input P1 and P2 (IP) or Input Relative P1 and P2 (IR) commands.)

After you have defined the positions for P1 and P2, or have accepted the default, use this imaginary rectangle to set up scaling for your drawing. With the Scale (SC) command you specify how many sections the rectangle divides into horizontally (the X-axis) and how many sections the rectangle divides into vertically (the Y-axis). With this process you have created your user-units.

Scaling also allows you to enlarge or reduce your image by changing the locations of P1 and P2. P1 and P2 represent physical locations in relation to the PCL Picture Frame. When the imaginary rectangle formed by P1 and P2 is enlarged or reduced with the IP or IR commands, the HP-GL/2 image is also enlarged or reduced to fit the new P1/P2 rectangle. (For a more detailed explanation of scaling and the Scale (SC) command, see Chapter 19.)

For importing existing HP-GL/2 images, another method of enlarging or reducing drawings exists. It involves varying the size of the PCL Picture Frame and is described next. This method allows you to scale an image while maintaining the aspect ratio of all elements (including fonts). The Scale command does not affect the size of fonts.

Absolute and Relative Pen Movement

The Plot Absolute (PA) and Plot Relative (PR) commands allow you to set whether you want to draw using absolute or relative “pen” moves. *Absolute* pen movement uses X,Y coordinates to specify an exact, fixed point relative to the origin (0,0). In Figure 17-9, the coordinates (3,8), (5,4), and (8,1) are always in the same place with respect to the origin, no matter where the pen is when the coordinates are issued.

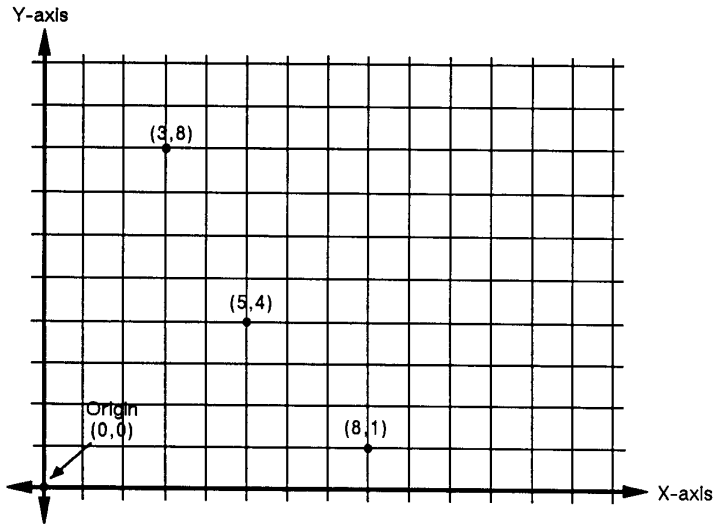

Figure 17-9 Absolute Coordinates

Relative pen movement uses X,Y *increments* to specify the number of units the pen moves from its current pen location. All commands that use relative increments include “relative” in their name (except the PE command). (An example is the Edge Rectangle Relative (ER) command).

In Figure 17-10 for example, assume that the pen is currently at the origin (0,0). To move to the absolute points shown in Figure 17-9 using relative coordinates, count 3 units to the right and 8 units up from the current pen location; these are both positive directions with respect to the origin. This is the relative location (3,8). Now move 5 positive X-units and 7 negative Y-units from this location to the lower point; this is the relative location (5,-7). From this location, move to the last point by moving 3 negative X-units and 3 positive Y-units (-3,3).

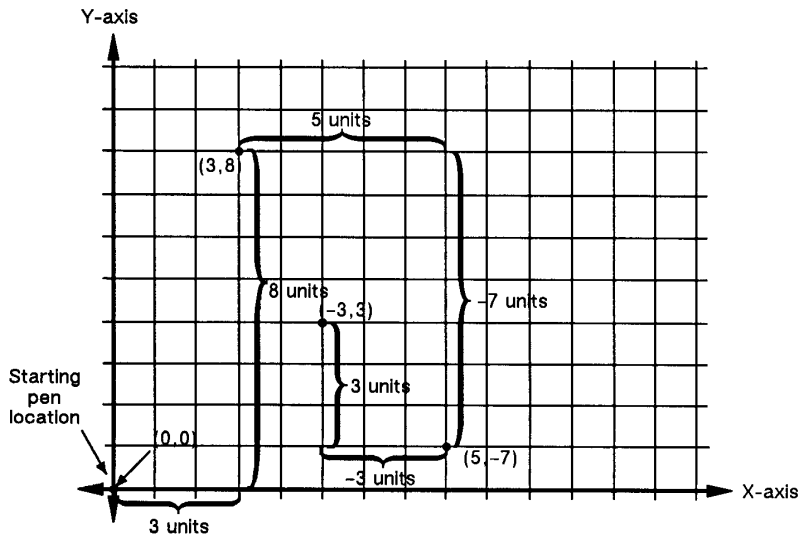

Figure 17-10 Relative Coordinates

Relative movement is useful in many applications where you know the dimensions of the shape you want, but do not want to calculate the absolute coordinates. For example, if you want a box 4 X-units by 8 Y-units, you can use the Edge Rectangle Relative (ER) command to draw the box without having to calculate the absolute coordinates of the opposite corner. (The ER command draws a rectangle using the current pen location as one corner, and the specified relative coordinates as the opposite corner.)

Absolute pen movement is the default mode; coordinates received within a PU (Pen Up) or PD (Pen Down) command are interpreted as absolute plotter units unless a PR (Plot Relative) command establishes relative mode. As with absolute coordinates, the relative units can be either user-units or plotter units, depending on whether the SC command is in effect.

Note

Relative increments add to the current pen location. The printer automatically converts the new relative location to absolute coordinates and updates the current pen location. Using relative coordinates can be faster in cases where the I/O speed limits your print speed, since relative coordinates are generally smaller numbers and therefore transmit less data over the I/O.

18 The Picture Frame

Introduction

When importing an existing HP-GL/2 file, or creating an HP-GL/2 image within an application, you use several PCL commands to set up the picture frame size, choose the picture frame location, and enter and exit HP-GL/2 mode. This chapter explains these PCL commands.

The following terms are used in this discussion:

Picture presentation directives are a group of PCL commands which:

- Provide the means to enter and exit HP-GL/2 context.
- Define a delimiting rectangle for the graphic image.
- Specify a scaling factor so existing HP-GL/2 graphics can be scaled and placed anywhere on the PCL logical page.

Picture frame refers to the destination rectangle when transferring HP-GL/2 graphics into the PCL logical page. The PCL picture frame size commands specify the size of the destination rectangle.

Picture frame scaling factor is the ratio of the size of the picture frame to the size of the source HP-GL/2 plot. There may actually be two scaling factors, one for the x direction and one for the y direction.

Picture frame anchor point refers to the upper left corner of the picture frame, which is set to the current active position (CAP) in the PCL environment at the time the picture frame anchor point command is executed.

Defining the Image Area(PCL Picture Frame)

There is a group of commands that allows you to specify an area on the page for placing an HP-GL/2 graphic image. These commands are the *Picture Presentation Directives* and are used to define a bounding rectangle to contain the HP-GL/2 image.

Figure 18-1 illustrates the Picture Presentation Directives. The rectangular area surrounding the image is the *PCL Picture Frame* and the location on the page of the PCL Picture Frame is determined by the *picture frame anchor point*. Refer to Figures 2-3 and 2-4 for the default picture frame size.

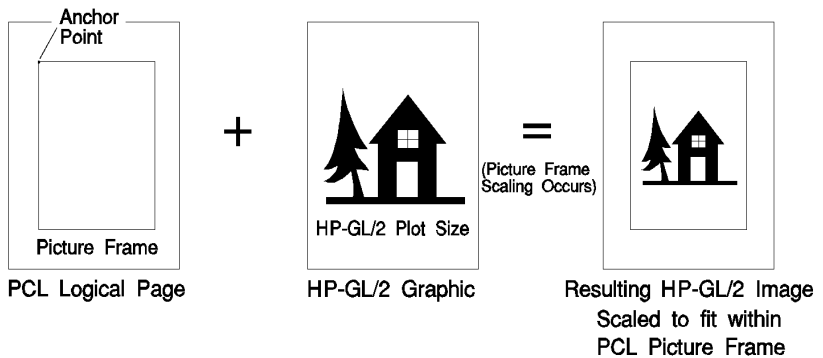

Figure 18-1 The Picture Presentation Directives

Automatically Adjusting Image Size to Fit the PCL Picture Frame

FrameImported HP-GL/2 drawings can be adjusted automatically to fit the size of the PCL Picture Frame without changing the locations of P1 and P2 (in Scale mode, as described earlier). This is called *picture frame scaling*.

When using picture frame scaling, specify the HP-GL/2 plot size unless the drawing is page size-independent (described below). If a drawing *is not* page size-independent, the printer will not adjust the size of the image to fit the picture frame without the HP-GL/2 plot size command; the drawing and the picture frame are assumed to be the same size. If a drawing *is* page size-independent, it automatically enlarges or reduces to fit within the picture frame without specifying an HP-GL/2 plot size.

Creating a Page Size-Independent Plot

As mentioned, if an imported HP-GL/2 drawing is page size-independent, it is adjusted automatically to fit different page sizes without specifying the HP-GL/2 plot size. For a drawing to be page size-independent, it must not specify any parameters in absolute units. This implies that:

- No parameter of any command is in plotter units. The scaled mode (SC command) must be used exclusively; either the default locations of P1 and P2 are used, or their positions are specified with the IR (Input Relative P1 and P2) command. The default window is used, or the window is specified in user-units (using the IW command).
- For labels, only the SR (Relative Character Size) mode is used; the SI (Absolute Character Size) mode is not used.
- The Pen Width selection mode (WU) is specified as relative instead of metric.
- The pattern length for the Line Type (LT) is specified as relative instead of metric.
- Scalable fonts are used exclusively.
- The default window is used, or the window is specified in user-units.
- The DR command (relative direction) is used for label direction (*not* DI — absolute direction).

If a drawing does not meet the above criteria and the drawing is not the same size as the picture frame, the HP-GL/2 plot size must be specified to accomplish the desired scaling. If it is not specified, the image is clipped to the effective window and no scaling occurs.

Note

The above bulleted items are required for automatic scaling when the picture frame size changes, *without* specifying the HP-GL/2 plot size. However, if an HP-GL/2 plot size is specified, *any* unscaled HP-GL/2 image (any image created without the SC command) is automatically enlarged or reduced to fit the PCL Picture Frame; the amount of enlargement or reduction is determined by the picture frame scaling factor (the ratio of the HP-GL/2 plot size to the PCL Picture Frame size). See Chapter 19 to specify an HP-GL/2 plot size.

Typical HP-GL/2 PlotCommand Sequence

Before we discuss the actual commands and how they operate, we will demonstrate the general sequence in which these commands are used to print HP-GL/2 files.

The following command sequence is usually followed when creating HP-GL/2 images:

- Send the *job control* and *page control* commands, and any other PCL commands that you wish to send before drawing the HP-GL/2 image. (See Chapters 3, 4, and 5 for job control and page control information.)
- Specify the PCL Picture Frame dimensions using the $E_C*c\#X$ (Picture Frame Horizontal Size) and $E_C*c\#Y$ (Picture Frame Vertical Size) commands. These commands determine the boundary of the window in which you place or draw your image. The PCL Picture Frame represents the maximum boundary for your HP-GL/2 drawing.
- Specify the *picture frame anchor point* using the E_C*c0T (Set Picture Frame Anchor Point) command. This command determines the position on the logical page where the upper left corner of the PCL Picture Frame is placed. Receipt of this command establishes the PCL picture frame anchor point at the PCL current cursor position.
- If importing an existing plot, defined in absolute units, specify the HP-GL/2 plot size using the $E_C^E_C*c\#K$ (Horizontal HP-GL/2 Plot Size) and $E_C*c\#L$ (Vertical HP-GL/2 Plot Size). This plot size represents the size of the original HP-GL/2 image. *If you are creating a drawing within an application, do not send these commands.*
- Enter HP-GL/2 mode using the $E_C\% \#B$ command.
- Send HP-GL/2 commands (IN;SP1;. . .).
- Exit HP-GL/2 mode by sending the $E_C\% \#A$ (Enter PCL Mode) command.
- Send more PCL commands if desired or issue an E_C^E command to end the job and eject the page.

Note

Whenever a printer reset (E_C^E) is sent at the beginning of a job, precede it with a UEL ($E_C\% -12345X$) command; whenever a printer reset is sent at the end of a job, follow it with a UEL command.

Table 18-1 Example: Creating and Using a PCL Picture Frame

$E_C E$	Reset the printer.
$E_C \&l2A$	Set the page size to letter.
$E_C \&l00$	Specify portrait orientation.
$E_C *c3060x3960Y$	Specify a 4.25-inch wide by 5.5-inch high PCL Picture Frame (4.25in. x 720 decipoints/in. = 3060 decipoints; 5.5in. x 720 decipoints/in. = 3960 decipoints).
$E_C *p565x600Y$	Move the cursor to the point you desire as the picture frame anchor point.
$E_C *c0T$	Set the picture frame anchor point to the current cursor position.
$E_C *c8.5k11L$	Specify that the original HP-GL/2 plot size is 8.5 inches wide by 11 inches high. This sets up a scaling factor of 2:1 because the original HP-GL/2 plot size is twice as large as the PCL Picture Frame (4.25 x 5.5 inches). <i>(If you are creating a drawing within an application instead of importing an existing plot, do not send this command.)</i>
$E_C \%1B$	Enter HP-GL/2 mode with the pen (HP-GL/2 cursor) at the PCL cursor position. In this example, the cursor would be at the picture frame anchor point (600 PCL Units down from the top of the logical page and 565 PCL Units to the right of the left logical page boundary).

Table 18-1 Example: Creating and Using a PCL Picture Frame

IN;SP1;PU50,50;	Send the HP-GL/2 commands you desire to send. (The IN command defaults the pen position to the HP-GL/2 origin, the lower-left corner of the PCL Picture Frame.)
$E_C\%1A$	Enter the PCL mode with the cursor at the current HP-GL/2 pen position.
TextTextText	Send some text or more PCL commands.
$E_C E$	Reset the printer to end the job and eject a page.

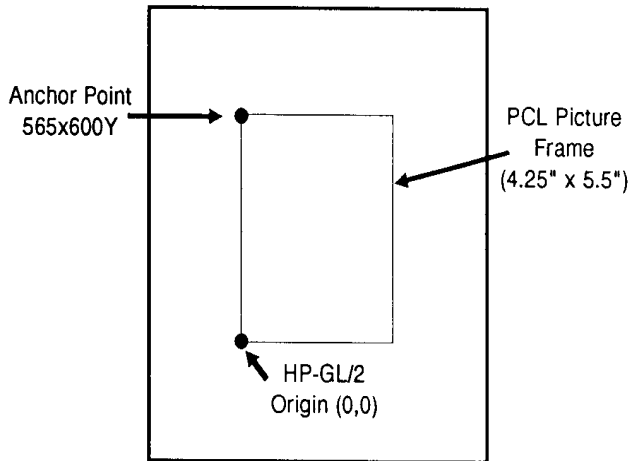

Figure 18-2

The previous example provides an idea of the commands involved in printing an HP-GL/2 plot, whether importing an existing drawing or creating one within an application. The example describes one way to print a plot, but many things can be varied such as the picture frame size and location, and the cursor position when entering and leaving HP-GL/2 mode.

Note

If you have a page size-independent HP-GL/2 image, there is no need to set plot size, otherwise it is good practice to set plot size.

The commands that allow you to set up a PCL Picture Frame and enter/exit HP-GL/2 mode are discussed in detail in the rest of this chapter. By reading the following command descriptions, you can see how changing command parameters can affect your printed output.

Horizontal Picture Frame Size

This PCL command specifies the horizontal dimension of the window to be used for printing an HP-GL/2 plot.

$$E_C * c \# X$$

=Horizontal size in decipoints (1/720th inch)

Default = width of the current logical page
Range = 0 - 32767 (valid to 4 decimal places)

Note

The horizontal dimension specified is parallel to the PCL X-axis when the print direction is set to 0 degrees (the default).

Using this command defaults the location of P1 to the lower left corner of the picture frame, and P2 to the upper right corner of the picture frame. It also resets the soft-clip window to the PCL Picture Frame boundaries, clears the polygon buffer, and updates the HP-GL/2 pen position to the lower-left corner of the picture frame (P1), as viewed from the current orientation.

If no horizontal picture frame size command is used, the printer defaults the picture frame size to the logical page width. A parameter value of 0 or the PCL *reset*, *UEL*, *page length*, *paper size*, or *orientation* commands default the horizontal picture frame size.

If an HP-GL/2 plot size is specified, the horizontal picture frame size is used to determine the horizontal scaling factor used for scaling the image to fit in the picture frame.

Example:

To specify a horizontal picture frame size of 5 inches, send:

$$^E_C * c 3600 X$$

(5 in. x 720 decipoints/in. = 3600 decipoints).

Vertical Picture Frame Size (Decipoints)

This PCL command specifies the vertical dimension of the window used for printing an HP-GL/2 plot.

$$^E_C * c \# Y$$

= Vertical size in decipoints (1/720th inch)

Default = The distance between the default top and bottom margins (the default text length)

Range = 0 - 32767 (valid to 4 decimal places)

Note

The vertical dimension specified is parallel to the PCL Y-axis when the print direction is set to 0 degrees (the default).

Example: To specify a vertical picture frame size of 6.5 inches, send:

$$^E_C * c 4680 Y$$

(6.5 in. x 720 decipoints/in. = 4680 decipoints)

Set Picture Frame Anchor Point

This command sets the location of the PCL Picture Frame anchor point to the PCL cursor position.

$$^E_C * c 0 T$$

Default = 0
Range = 0

The position of the picture frame anchor point defines the location of the upper left corner of the PCL Picture Frame. The “upper left” refers to the corner for which X and Y coordinates are minimized when the print direction is 0.

A parameter value of zero ($^E_C * c 0 T$) specifies that the picture frame anchor point should be set to the cursor position. Sending a cursor move command prior to sending this command places the picture frame anchor in the desired location. All parameter values other than zero are ignored, but if you do not send a Set Picture Frame Anchor command, the printer defaults the anchor point to the left edge of the logical page and the default top margin.

Note

The print direction command does not affect the physical location of the anchor point or the picture frame.

Using this command defaults the location of P1 and P2, resets the soft-clip window to the PCL Picture Frame boundaries, clears the polygon buffer, and updates the HP-GL/2 pen position to the lower left corner of the picture frame (if entered with $^E_C \% 0 B$), as viewed from the current orientation.

Example:

To set the picture frame anchor point to a position 6 inches from the left logical page boundary and 5 inches below the top margin, send:

$$^E_C * p 1800 x 1500 Y ^E_C * c 0 T$$

In this example, the cursor is first moved to the desired location (6 inches x 300 dots/inch = 1800 dots; 5 inches x 300 dots/inch = 1500 dots). Then the $^E_C * c 0 T$ command sets the picture frame anchor point to that location.

HP-GL/2 Plot Horizontal Size

This command specifies the horizontal size of the HP-GL/2 drawing being imported.

$E_C * c \# K$

=The horizontal size in inches

Default = width of the currently selected picture frame
Range = 0 to 32767 (valid to 4 decimal places)

The horizontal HP-GL/2 plot size determines the horizontal scaling factor used to fit the drawing into the PCL Picture Frame. For example, if the horizontal HP-GL/2 plot size is specified as 12 inches and the PCL Picture Frame width is 4 inches, the horizontal scaling factor would be 3:1; the horizontal component of the image would be reduced to one-third its original size to fit into the PCL Picture Frame.

A parameter value of zero or a *reset*, *page length*, *paper size*, or *orientation* command defaults the HP-GL/2 plot size to the width of the currently selected picture frame, resulting in no scaling.

Example:

If the original HP-GL/2 drawing is 8.5 inches wide, send:

$E_C * c8.5K$

HP-GL/2 Plot Vertical Size

This command specifies the vertical size of the HP-GL/2 drawing being imported.

$E_C * c \# L$

=The vertical size in inches

Default = height of the currently selected picture frame
Range = 0 to 32767 (valid to 4 decimal places)

The vertical HP-GL/2 plot size value determines the vertical scaling factor used to fit the drawing into the PCL Picture Frame. For example, if the vertical HP-GL/2 plot size is specified as 7 inches and the PCL Picture Frame height is 14 inches, the vertical scaling factor would be 1:2; the vertical component of the image would be enlarged to twice its original size to fit into the PCL Picture Frame.

A parameter value of zero or a *reset*, *page length*, *paper size*, or *orientation* command defaults the HP-GL/2 plot size to the height of the currently selected picture frame, resulting in no scaling.

Example:

If the original HP-GL/2 drawing is 7 inches tall, send:

$E_C * c7L$

Enter HP-GL/2 Mode

This command causes the printer to interpret subsequent commands as HP-GL/2 commands, instead of PCL printer language commands.

$E_C \% \# B$

=0— Position pen at previous HP-GL/2 pen position
1 — Position pen at current PCL cursor position

Default = 0

Range = 0, 1 (even values are mapped to 0; odd values are mapped to 1; $E_C \% B$ is the same as $E_C \% 0B$)

As soon as the printer receives this command, it switches to HP-GL/2 mode, interpreting commands as HP-GL/2 commands until it receives an Enter PCL Mode, $E_C E$, or UEL command, or until the printer power is switched off and on. (For information on the effect of PCL settings on HP-GL/2 mode, see “Default Settings” later in this chapter.)

The value field (#) determines the cursor position once HP-GL/2 mode is entered.

0— This parameter option ($E_C \% 0B$) sets the pen position to the previous HP-GL/2 position; if this is the first time HP-GL/2 mode is entered in the present print job (assuming an $E_C E$ has been sent), the pen position is at the lower left corner of the PCL Picture Frame (0,0).

1— This parameter option ($E_C \% 1B$) specifies that the pen position be the same as the current PCL cursor position.

Example:

To set the pen position to the current PCL cursor position, send:

$E_C \% 1B$

Enter PCL Mode

This command causes the printer to return to PCL mode from HP-GL/2 mode.

$E_C \% \# A$

=0— Position cursor at previous PCL cursor position.
1 — Position cursor at current HP-GL/2 pen position.

Default = 0
Range = 0, 1 (even values are mapped to 0; odd values are mapped to 1)

Sending the Enter PCL Mode command causes the printer to stop interpreting the incoming data as HP-GL/2 commands and to begin interpreting the data as PCL commands. The value field (#) specifies the cursor position when PCL mode is entered.

0— A 0 parameter ($E_C \% 0A$) sets the pen position to the previous PCL position (the cursor position before entering HP-GL/2 mode).

1— A 1 parameter ($E_C \% 1A$) sets the cursor position to the current HP-GL/2 pen position. If the current HP-GL/2 pen position is outside the bounds of the PCL logical page, the nearest point on the logical page boundary becomes the new PCL cursor position.

No PCL variables except the cursor position are affected by entering and exiting HP-GL/2 mode.

Example:

To exit HP-GL/2 mode using the current active cursor position (CAP) that existed before entering HP-GL/2 mode, send:

$E_C \% 0A$

Default Settings

When you enter HP-GL/2 mode, most vector graphics variables retain their previous HP-GL/2 value. However, the following changes in the PCL environment can affect the HP-GL/2 environment:

- Resetting the printer ($\text{E}_{\text{C}}\text{E}$ or control panel reset):
 - Executes an IN (Initialize) command
 - Defaults the PCL Picture Frame size
 - Defaults the PCL Picture Frame anchor point
 - Defaults the HP-GL/2 plot size
 - Defaults the PCL logical page orientation
- A page size, page length, or orientation command:
 - Defaults the PCL Picture Frame anchor point
 - Defaults the PCL Picture Frame
 - Defaults the HP-GL/2 plot size
 - Defaults P1 and P2 (IP,IR commands)
 - Resets the soft-clip window to the PCL Picture Frame boundaries (IW command)
 - Clears the polygon buffer (PM0,PM2)
 - Updates the cursor to the lower-left corner of the picture frame (P1).
- Redefining the PCL Picture Frame:
 - Defaults P1 and P2 (IP,IR commands)
 - Resets the soft-clip window (IW) to the PCL Picture Frame boundaries.
 - Clears the polygon buffer (PM0,PM2)
 - Updates the current pen position to the lower-left corner of the picture frame (P1)
- Setting the picture frame anchor point:
 - Defaults P1 and P2 (IP,IR commands)
 - Resets the soft-clip window to the PCL Picture Frame boundaries (IW command)
 - Clears the polygon buffer (PM0,PM2)
 - Updates the current pen position to the lower-left corner of the picture frame (P1)
- Setting an HP-GL/2 plot size:
 - Changes the picture frame scaling factor

As the printer enters HP-GL/2 mode for the first time since $E_C E$, power-on, or control panel reset, all HP-GL/2 variables are at their default settings, as determined by the Picture Presentation Directives (the PCL Picture Frame Size, Picture Frame Anchor Point, and HP-GL/2 Plot Size commands).

Table 18-2 Example: Creating a Simple Drawing

$E_C E$	Reset the printer.
$E_C \&\&I2A$	Set the page size to letter.
$E_C \&\&I00$	Specify portrait orientation.
$E_C *c3600x3600Y$	Specify a 5-inch wide by 5-inch high PCL Picture Frame (5in. x 720 decipoints/in. = 3600 decipoints).
$E_C *p450x675Y$	Move the cursor to the point you desire as the picture frame anchor point.

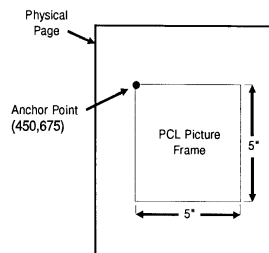

$E_C *c0T$	Set the picture frame anchor point to the cursor position.
------------	--

Table 18-2 Example: Creating a Simple Drawing (continued)

$E_C\%1B$ Enter HP-GL/2 mode with the cursor (pen) at the PCL cursor position. In this example, the cursor is at the picture frame anchor point (450 dots [1.5 in.] down from the top margin and 675 dots [2.25 in.] to the right of the left logical page boundary).

`IN;SP1;` Initialize HP-GL/2 command values and select pen number 1 (black). (The IN command moves the pen position from the anchor point to the HP-GL/2 origin, the lower-left corner of the PCL Picture Frame.)

`SC0,100,0,100;` Set up user scaling so that P1 is (0,0) and P2 is (100,100) (these points are the lower-left and upper-right corners of the PCL Picture Frame, respectively).

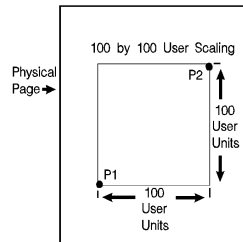

`PD100,0,100,100,0,100,0,0;` Draw a box marking the perimeter of the PCL Picture Frame.

Table 18-2 Example: Creating a Simple Drawing (continued)

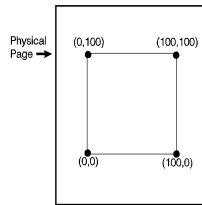

PU50,50;CI25;

Lift the pen and move to the center of the PCL Picture Frame (50,50); draw a circle with a radius that is 25% of the picture frame width.

E_C%1A

Enter the PCL mode with the cursor at the current HP-GL/2 pen position.

E_CE

Reset the printer to end the job and eject a page.

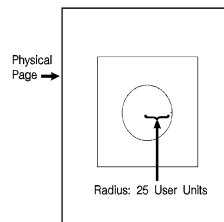

Note

Any line drawn along the border of the effective window will cause the line to be clipped, producing a line width one-half of the defined pen width. For example, all the lines drawn in the above example are half the width of the other lines since they are clipped at the window borders.

19 The Configuration and Status Group

Introduction

The configuration and status group commands help you:

- Establish default conditions and values for HP-GL/2 features.
- Scale images in the dimensional units you want to use.
- Enlarge/reduce images for different media sizes.
- Establish a window (soft-clip limits).
- Draw equal-sized and mirror-imaged drawings.
- Rotate the HP-GL/2 coordinate system.
- Add comments to your HP-GL/2 command sequence.

Table 19-1 lists the commands described in this chapter.

Table 19-1 The Configuration and Status Group Commands

Command	Summary
CO, Comment	Allows comments to be included in an HP-GL/2 command sequence.
DF, Default	Sets most programmable HP-GL/2 features to their default conditions.
IN, Initialize	Sets all programmable HP-GL/2 features to their default conditions.
IP, Input P1 and P2	Establishes new or default locations for the scaling points P1 and P2.
IR, Input Relative P1 and P2	Establishes P1 and P2 locations as a percentage of the PCL Picture Frame.
IW, Input Window	Sets up a window (soft-clip limits).
PG, Advance Full Page	This command is ignored. ¹
RO, Rotate Coordinate System	Rotates the HP-GL/2 coordinate system.
RP, Replot	This command is ignored.
SC, Scale	Establishes a user-unit coordinate system.

1. These commands, useful in plotter applications, are not the optimal solution for PCL 5 printers. Other PCL commands perform similar functions (see the Number of Copies and Form Feed command descriptions).

Establishing Default Conditions

Whether you are using HP-GL/2 mode or strictly the PCL printer language mode, you should establish default conditions at the beginning of each print job to prevent unexpected results due to “leftover” command parameters from a previous job. From within HP-GL/2 mode there are two ways to establish default conditions: using the Initialize (IN) command or using the Default (DF) command.

Using the IN command sets the printer to its user-selected defaults. This process is called initialization. The reset command ($E_C E$) executes an Initialize (IN) command automatically, so if a reset was sent at the beginning of your print job, HP-GL/2 command parameters are at their user-selected default state when HP-GL/2 mode is first entered. (See Chapter 3 for a more thorough discussion of the printer environment and how it is affected by the reset command.)

Note

HP-GL/2 command parameters are set to their default values the first time HP-GL/2 mode is entered during a print job (assuming that an $E_C E$ reset is sent at the beginning of the job). After commands have been sent to modify the current print environment, the command parameters are no longer set to their defaults. When re-entering HP-GL/2 mode, immediately sending an IN command ensures that HP-GL/2 features are set to their default conditions (if that is desired).

The DF command is not as powerful as the IN command. The conditions set by the DF and IN commands are described later in this chapter.

The Scaling Points P1 and P2

When you scale a drawing, you define your own units of measurement, which the printer then converts to plotter units. Scaling relies on the relationship between two points: P1 and P2. These two points are called the scaling points because they take on the user-unit values that you specify with the Scale (SC) command. You can change the locations of P1 and P2 using either the Input P1 and P2 (IP), or Input Relative P1 and P2 (IR) command.

P1 and P2 always represent an absolute location in relation to the PCL Picture Frame, defined in plotter-units. They designate opposite corners of a rectangular printing area within the picture frame. You can change the size of the rectangular printing area and move it anywhere within the picture frame, or even outside the picture frame, depending on the plotter-unit coordinates you specify using the IP or IR commands.

Using the Scale Command

Scaling allows you to establish units of measure with which you are familiar, or which are more logical to your drawing. The Scale command (SC) determines the number of user-units along the X- and Y-axes between P1 and P2. The actual size of the units depends on the locations of P1 and P2 and the range of user-units set up by the SC command.

There are three types of scaling:

- Anisotropic
- Isotropic
- Point-factor

Anisotropic scaling indicates that the size of the units along the X-axis may be different than the size of the units on the Y-axis.

Isotropic scaling, then, indicates that the units are the same size on both axes. **Point-factor scaling** sets up a ratio of plotter units to user-units.

The Scale command does not change the locations of P1 and P2, only their coordinate values. Also, scaling is not limited to the rectangular area defined by P1 and P2, but extends across the entire printing area within the PCL Picture Frame.

For example, to divide the X-axis into 12 units, and the Y-axis into 10 units, specify the X-axis to scale from 0 to 12, and the Y-axis to scale from 0 to 10. P1 becomes the origin with user-unit coordinate (0,0) and P2 becomes (12,10). The entire plotting area is now divided into the desired units. Subsequent plotting commands use these units (see Figure 19-1). If you command the printer to move to the point (3,4), the printer moves to the location equivalent to (3,4) user-units (*not* (3,4) plotter units).

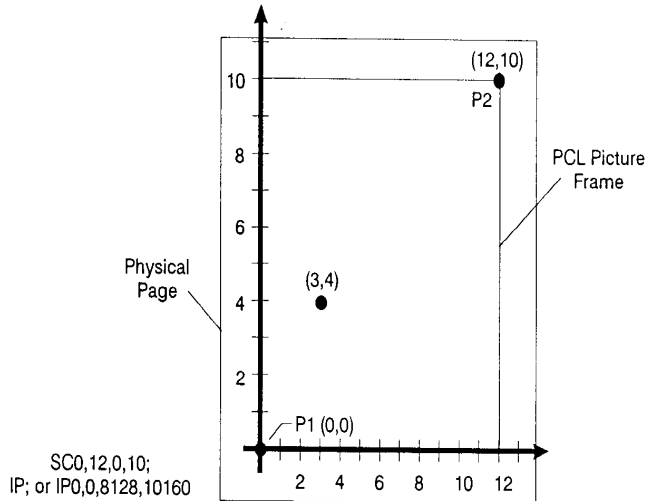

Figure 19-1 User-Unit Scaling with Default P1 and P2

If you move the locations of P1 and P2, the size of the user-units changes. Assume that the previous illustration showed P1 and P2 in their default locations (the lower-left and upper-right corners, respectively, of the PCL Picture Frame). In Figure 19-2, P1 and P2 have the same user-unit values (set with the Scale command [SC]), but their physical locations have been changed (using Input P1 and P2 [IP]). Note that the size of the user-units decreased.

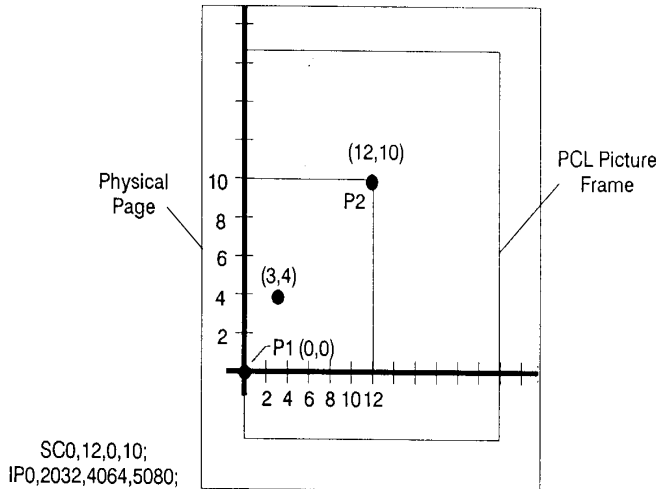

Figure 19-2 Same User-Unit Scaling with New P1 and P2

To further illustrate the flexibility of user-unit scaling, Figure 19-3 shows the P1 and P2 locations with negative user-unit values. Note that the framework set by the scaling points P1 and P2 is *not* a graphics limit. The user-unit coordinate system extends across the entire PCL Picture Frame area. You can print to a point beyond P1 or P2 as long as you are within the PCL Picture Frame. In Figure 19-3, P1 is in the -X and -Y quadrant.

Note

You can use coordinate points that are outside of the PCL Picture Frame boundaries or even off of the page, but only that portion of the vector graphics image that falls within the effective window is printed. For example, you can draw a small portion of the circumference of a circle with a 5-foot radius by moving the pen 5 feet from the page and issuing a C1 command (specifying a 5-foot radius); only the portion of the arc that falls within the effective window is printed.

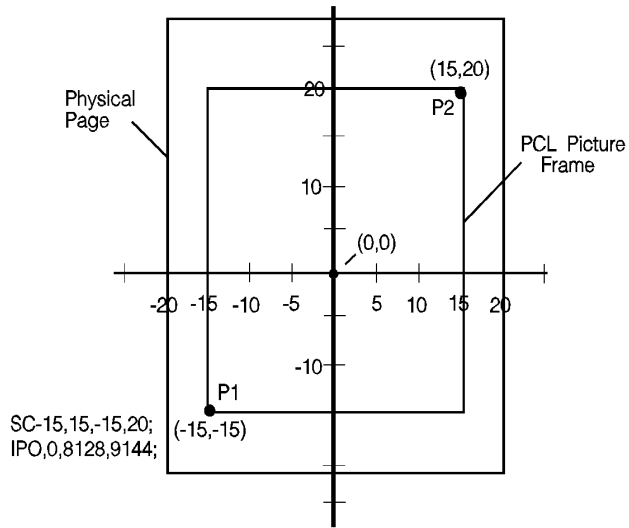

Figure 19-3 New P1 and P2 User-Unit Scaling with Negative Values

Refer to the Scale (SC) command at the end of this chapter for more information on scaling drawings.

Using Scaling Effectively

The following sections describe how to combine scaling and P1/P2 concepts to do the following.

- Enlarge or reduce the size of a drawing
- Draw equal-size pictures on the same page.
- Create mirror-imaged pictures

Enlarging or Reducing a Picture

The basic technique for changing a picture's size is to scale the printing area defined by P1 and P2, then move the locations of P1 and P2 to define a smaller or larger area. This is especially useful when you want to print the picture on any portion of the page.

Note

Only scaled drawings (those using the SC command) are enlarged/reduced when the P1/P2 locations change. Use PCL Picture Frame scaling when importing HP-GL/2 images created without the SC command (see "Automatically Adjusting the Image Size" in Chapter 18).

To maintain the proportions of scaled plots, set P1 and P2 to define an area with the same aspect ratio as the original scaling rectangle. For example, if the area defined by P1 and P2 is 3000 x 2000 plotter units, its aspect ratio is 3:2. To enlarge the plot, set P1 and P2 to define a larger area that maintains a 3:2 ratio.

The following example illustrates this technique using a square P1/P2 scaling rectangle with a scale of 0 to 10 for both axes. By definition, a square always has an aspect ratio of 1:1. After drawing a circle within the scaled area, the locations of P1 and P2 move to form a new square area that maintains the 1:1 ratio. Note that the circle printed in the new area is smaller but is proportionately identical.

Table 19-2 Example: Changing the Size of a Drawing

E _C %0B	Enter HP-GL/2 mode, using the default picture frame size and anchor point.
IN;	Initialize HP-GL/2 mode.
IP0,0,2000,2000;	Set P1 to be (0,0) and P2 to be (2000,2000).
SC0,10,0,10;	Set up user-unit scaling to range from (0,0) to (10,10).
SP1;	Select pen number 1. Even though there is no physical pen, the SP command must be used to enable printing.
PA5,5;	Begin absolute plotting from the center of the square (5,5).
CI3;	Print a circle with a radius of 3 user-units.
IP2500,500,3500,1500;	Input a new P1 and P2 position for printing the smaller circle.
PA5,5;	Begin absolute plotting from the center of the new square (5,5).
CI3;	Print the second circle with a radius of 3 user-units.
E _C %0A	Enter PCL Mode.
E _C E	Reset the printer to complete the job and eject the page.

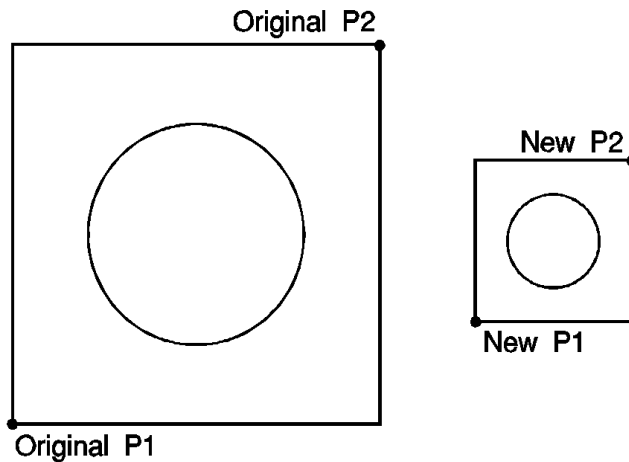

Figure 19-4 Changing the size of a drawing

Drawing Equal-Size Pictures on a Page

You may occasionally want to print more than one drawing on the same page for a side-by-side comparison. This can be useful for comparing parts, assemblies, layouts, or other similar information. The easiest way to draw equal-sized

pictures on one piece of paper is to take advantage of the fact that P2 follows P1 whenever you change the location of P1.

The following example illustrates this feature. The example locates P1 and P2 on the left side of the paper and scales the area for the first image. Then, for the second image, only the P1 location is moved to the right side of the paper; P2 automatically tracks P1, so the printing area retains the same dimensions as the first drawing. The printed rectangle around the second area shows P2 in its new location.

Table 19-3 Example: Drawing Equal-Size Pictures on a Page

$E_C E$	Reset the printer.
$E_C \&I1O$	Select landscape orientation.
$E_C \%0B$	Enter HP-GL/2 mode, using the default picture frame size and anchor point.
IN;	Initialize HP-GL/2 mode.
IP500,500,5450,7500;	Set P1 to be (500,500) and P2 to be (5450,7500).
SC0,10,0,15;	Set up user-unit scaling to range from (0,0) to (10,15).
SP1;	Select pen number 1. Even though there is no physical pen, the SP command must be used to enable printing.
PA0,0;	Begin absolute plotting from the origin (0,0).
PD10,0,10,15,0,15,0,0;PU;	Pen Down and print from (0,0) to (10,0) to (10,15) to (0,15) to (0,0); then Pen Up.
IP5550,500	Input a new P1 and allow P2 to automatically track it.
PA0,0;	Begin absolute plotting from the new origin.
PD10,0,10,15,0,15,0,0;PU;	Pen Down and print from (0,0) to (10,0) to (10,15) to (0,15) to (0,0); then Pen Up.
$E_C \%0A$	Enter PCL Mode.
$E_C E$	Reset the printer to complete the job and eject the page.

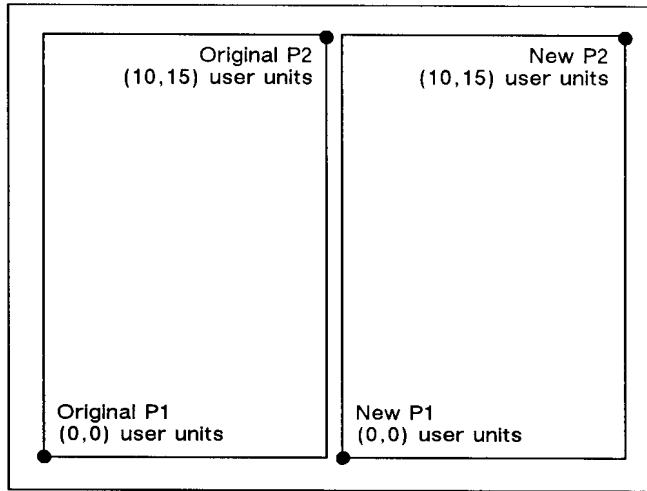

Figure 19-5 Drawing equal-size pictures on a page

Note

The P1/P2 frames are not windows or graphics limits; the pen can print HP-GL/2 images anywhere within the PCL Picture Frame. Note that the new P1 and P2 retain their scaled values. This allows you to use the same coordinates on both halves of the page. In contrast, if you do not assign a scale to P1 and P2, you must calculate the new plotter unit coordinates for the drawing on the second half of the page.

Creating Mirror-Images

For most drawings, you will probably set P1 and P2 so that P1 is in the lower-left corner and P2 is in the upper-right corner of the scaling area. However, you can change the relationship of P1 and P2 to produce a mirror-image effect.

You can “mirror-image” any *scaled* drawing (those drawings using the SC command) by changing the relative locations of P1 and P2, or changing the coordinate system by using SC. You can mirror-image labels using the Absolute Direction and Relative Direction (DI and DR) commands, the Relative Character Size (SR) command, or using the Absolute Character Size (SI) command. (The DI, DR, and SR commands are discussed in Chapter 23, *The Character Group*.)

The following example uses a subroutine to draw the same picture (an arrow) four times. Because the program changes the relative locations of P1 and P2, the direction of the arrow is different in each of the four drawings. The

program sets P1 and P2, draws the plot, then returns to reset P1 and P2 (using the IP command). This continues until all four possible mirror-images are plotted. (The original drawing is shown in each picture so you can compare the orientation of the mirror-image.)

Table 19-4 Example: Creating a Mirror-Image

E _C E	Reset the printer.
E _C %0B	Enter HP-GL/2 mode.
IN;	Initialize HP-GL/2 mode.
SP1;	Select pen number 1. You must use the SP command to enable printing.
IP1500,3600,3000,5100;	Specify the P1/P2 locations for the first arrow figure.
SC-15,15,-10,10;	Set up user scaling: (-15,-10) to (15,10).
(Run subroutine)	Run the subroutine (below) that prints the arrow image.
IP3000,3600,1500,5100;	Change the physical locations of P1 and P2 to flip the image to the left.
(Run subroutine)	Print the second image.
IP1500,5100,3000,3600;	Change the physical locations of P1 and P2 to flip the image down.
(Run subroutine)	Print the third image.
IP3000,5100,1500,3600;	Change P1/P2 locations to flip the image to the left and down.
(Run subroutine)	Print the fourth image.
E _C %0A	Enter the PCL mode.
E _C E	Send a reset to end the job and eject the page.

Table 19-4 Example: Creating a Mirror-Image (continued)

<p>SUBROUTINE: PA1,2;PD1,4,3,4,3,7,2,7, 4,9,6,7,5,7,5,4,12,4,12, 5,14,3,12,1,12,2,1,2; PU;</p>	<p>Subroutine that prints the arrow figure on the next page</p>
---	---

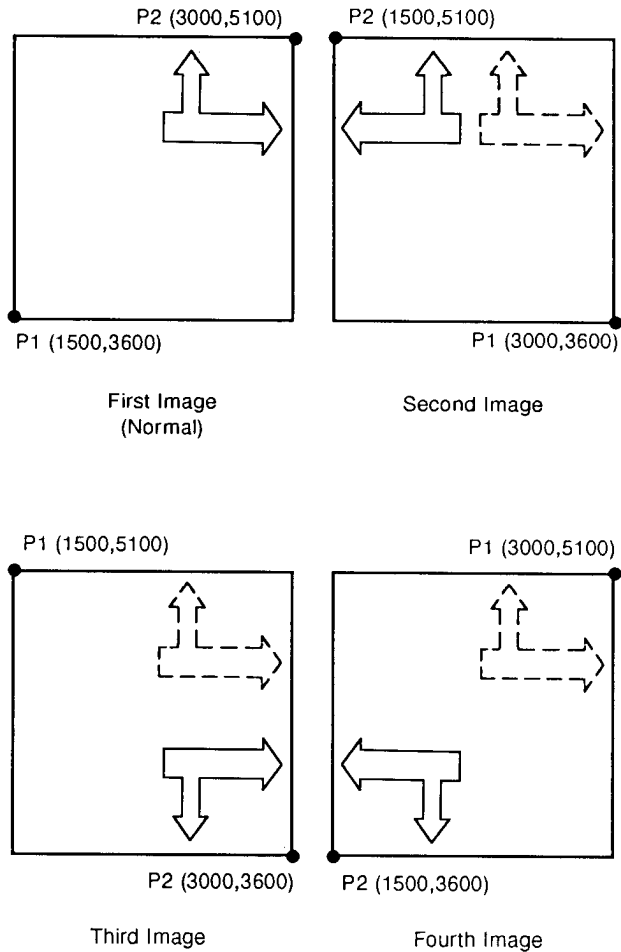

Figure 19-6 Creating a mirror-image

Adapting the HP-GL/2 Coordinate System to Match the PCL System

The following example uses the IP and SC commands to change HP-GL/2 coordinate system to match the default PCL coordinate system. The IP command is used to invert the Y-axis so that the Y values increase as the pen moves down the page. The SC command equates user-units to dot positions (300 dots-per-inch). The example draws a few lines in both PCL and HP-GL/2 modes to demonstrate that the coordinate systems are lined up correctly (the end points of the lines intersect).

Notes

Sending an IN (Initialize) or DF (Default) command causes the coordinate system to revert to the HP-GL/2 default.

Since this example is based on the default top margin and text length, changing the top margin or the text length moves the two coordinate systems out of alignment.

Table 19-5 Example: Adapting the HP-GL/2 Coordinate System to Match the PCL System in Portrait Orientation

$E_C E$	Reset the printer.
$E_C \&l2A$	Set the page size to letter.
$E_C \&l0O$	Specify portrait orientation.
$E_C \&l0E$	Set top margin to 0.
$E_C *p0x0Y$	Move to position (0,0).
$E_C *c5760x7920Y$	Set picture frame to 8" x 11" (size of logical page).
$E_C *c0T$	Set picture frame anchor point to current PCL cursor position (0,0).
$E_C \%1B$	Enter HP-GL/2 mode with the HP-GL/2 cursor or pen at the PCL cursor position.

Table 19-5 Example: Adapting the HP-GL/2 Coordinate System to Match the PCL System in Portrait Orientation

IN;SP1;	Initialize HP-GL/2 command values and select pen number 1 (black). (The IN command moves the pen position from the anchor point to the HP-GL/2 origin, the lower-left corner of the PCL Picture Frame.)
SC0,3.3867,0,-3.3867,2	Set-up a user scale with a user-unit equal to 1/300 inch. Scale command type 2, the scale is the ratio of plotter units/user-units (1016 plotter units-per-inch/300 dots-per-inch = 3.3867). The minus 2 Y-value changes the HP-GL/2 Y direction to match that of the PCL coordinate system.
IR0,100,0,100	Place P1 (point 0,0) at the top of the PCL picture frame.
PU0,0;	Lift the pen and move to (0,0) (upper left corner — since HP-GL/2 coordinate system now matches PCL coordinate system). Every subsequent pen move can be specified using the same coordinate numbers in either mode. The following commands demonstrate that the grids are synchronized.
PU300,300;PD600,600;	Lift the pen and move it to (300,300); then draw a line to (600,600). This draws a line at a 45° angle down from the starting point.
$E_C\%1A$	Enter the PCL mode with HP-GL/2's pen position being inherited as PCL's. CAP=(600,600).
$E_C*c300a4b0P$	Draw a horizontal line (rule) that is 300 PCL units wide by 4 PCL units. (Note that the cursor position after a rule is printed is at the beginning of the rule — in this case, (600,600).)

Table 19-5 Example: Adapting the HP-GL/2 Coordinate System to Match the PCL System in Portrait Orientation

$E_C\%1BPU;PR300,0;$ $PD;PR0,500;$	Enter HP-GL/2 mode (inheriting PCL's CAP) and lift the pen; move to a point 300 user-units (dots) to the right; place the pen down and print a line 500 user-units down.
$E_C\%1A$	Enter the PCL mode with the CAP at the current HP-GL/2 pen position.
$E_C E$	Reset the printer to end the job and eject a page.

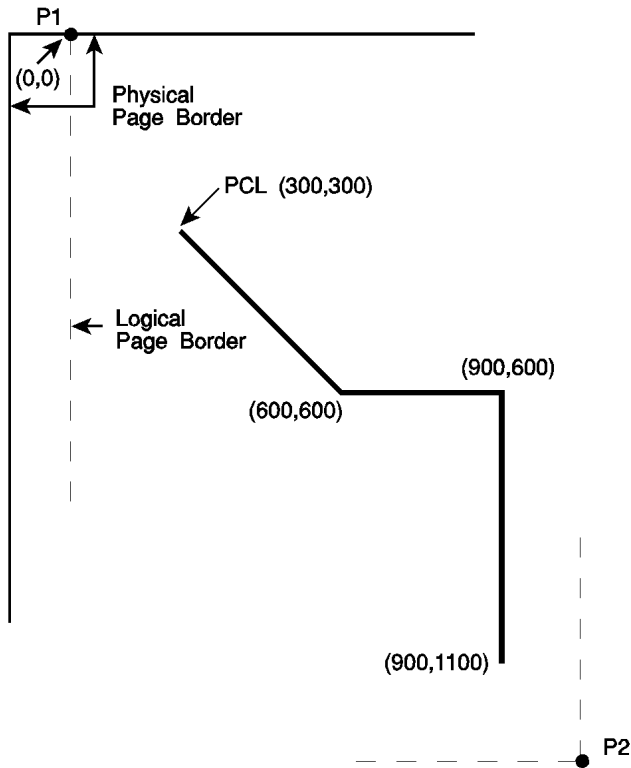

Figure 19-7 Adapting the HP-GL/2 coordinate system to match the PCL system in portrait orientation

Windowing: Setting Up Soft-Clip Limits

Soft-clip limits temporarily restrict pen movement to a rectangular area, or window. When you initialize or set the printer to default conditions, the soft-clip limits are the same as the PCL Picture Frame limits.

To create a window, you use the Input Window (IW) command. The printer does not draw outside the window.

The following illustration shows the four types of line segments you can specify from one point to another.

Table 19-6 The Four Types of Line Segments

Type	From Last Point	To New Point
1	Inside window area	Inside window area
2	Inside window area	Outside window area
3	Outside window area	Inside window area
4	Outside window area	Outside window area

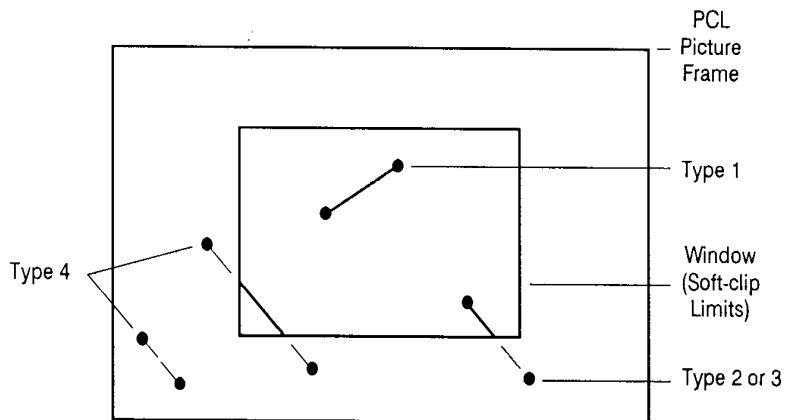

Figure 19-8 The four types of line segments

The IW command lets you control the size of the HP-GL/2 printing area so that you can draw a particular portion of a drawing. You can leave the rest as white space, or use the remaining area for labels, or another drawing. Refer to “The Vector Graphic Limits” in Chapter 17, and the IW command description later in this chapter.

CO, Comment

This command allows comments to be inserted within an HP-GL/2 command sequence. The comment string of the CO command must be delimited by double quotes.

CO “*text ... text*”

HP-GL/2 comments are ignored by the printer.

DF, Default Values

This command returns the printer’s HP-GL/2 settings to the factory default settings. Use the Default Values (DF) command to return the printer to a known state while maintaining the current locations of P1 and P2 (unlike the IN command). When you use DF at the beginning of a command sequence, graphics parameters such as character size, slant, or scaling are defaulted.

DF [;]

The DF command resets the printer to the conditions listed in Table 19-7.

Table 19-7 Default Conditions

Function	Command	Default Condition
Anchor Corner	AC	Anchor corner (not the same as the picture frame anchor point) set to lower-left corner of PCL Picture Frame, relative to the current coordinate system.
Alternate Font Definition	AD	Stick Font (11.5-pt., 9-cpi, upright, medium)
Character Fill Mode	CF	Solid fill, no edging.

Table 19-7 Default Conditions (continued)

Absolute Direction	DI1,0	Character direction parallel to X-axis.
Define Label Terminator	DT	ETX and non-printing mode.
Define Variable Text Path	DV	Text printed left to right with normal Line Feed.
Extra Space	ES	No extra space.
Fill Type	FT	Solid fill.
Input Window	IW	Set equal to PCL Picture Frame Window.
Line Attributes	LA	Butt caps, mitered joins, and miter limit=5.
Label Origin	LO1	Standard labeling starting at current location.
Line Type	LT	Solid line, relative mode, pattern length=4% of diagonal distance from P1 to P2.
Plotting Mode	PA	Absolute plotting.
Polygon Mode	PM	Polygon buffer cleared.
Raster Fill	RF	Solid black.
Scalable or Bitmap Fonts	SB0	Scalable fonts only.
Scale	SC	User-unit scaling off.
Screened Vectors	SV	No screening
Standard Font Definition	SD	Stick Font (11.5-pt., 9-cpi, upright, medium)
Absolute Character Size	SI	Turns off size transformation.
Character Slant	SL	No slant.
Symbol Mode	SM	Turns off symbol mode.
Select Standard Font	SS	Standard font selected.

Table 19-7 Default Conditions (continued)

Transparency Mode	TR1	Transparency mode on.
Transparent Data	TD	Normal printing mode.
User-Defined Line Type	UL	Defaults all 8 line types.

In addition, the printer updates the Carriage Return point for labeling to the current pen location. (See Chapter 23, *The Character Group*, for more information on the Carriage Return point.)

The DF command does not affect the following HP-GL/2 conditions.

- Locations of P1 and P2.
- Current pen, its location, width, width unit selection, and up/down position.
- HP-GL/2 drawing rotation.

Table 19-8 Related commands

Related Commands	Group
IN, Initialize	The Configuration/Status Group

IN, Initialize

This command resets all programmable HP-GL/2 functions to their default settings. Use the IN command to return the printer to a known HP-GL/2 state and to cancel settings that may have been changed by a previous command sequence. (The $E_{C}E$ Reset issues an automatic IN command.)

IN [;]

Notes

In this manual, all command sequence examples begin with IN to clear unwanted conditions from the previous command sequence, even though an $E_{C}E$ command automatically executes an IN command.

Once HP-GL/2 mode is entered and commands are issued, the HP-GL/2 conditions are no longer initialized. To place HP-GL/2 into the default state, send the IN command.

The IN command sets the printer to the same conditions as the DF command, plus the following:

- Raises the pen (PU).
- Returns the pen location to the lower-left corner of the PCL Picture Frame (PA0,0).
- Cancels drawing rotation (RO).
- Sets P1 and P2 to the lower-left and upper-right corners, respectively, of the PCL Picture Frame (IP).
- Sets pen width mode to metric; units are millimeters (WU).
- Sets the pen width to 0.35 mm (PW).
- Sets number of pens to 2 (black [1] and white [0]).

Table 19-9

Affected Commands	Group
DF, RO, IP	Configuration/Status Group
PD, PU,	Vector Group
WU, PW	Line and Fill Attributes Group

Table 19-10

Related Commands	Group
DF, Default Values	Configuration/Status Group

IP, Input P1 and P2

This command establishes new or default locations for the scaling points P1 and P2. P1 and P2 are used by the Scale (SC) command to establish user-unit scaling. You can also use IP in advanced techniques such as printing mirror-images, enlarging/reducing drawings, and enlarging/reducing relative character size, or changing label direction (see the previous discussion in this chapter).

IP $X_{P1}, Y_{P1}[X_{P2}, Y_{P2};]$ or

IP [:]

Parameter	Format	Functional Range	Default
$X_{P1}Y_{P1}[X_{P2}, Y_{P2};]$	integer	-2^{30} to $2^{30} - 1$	(see below)

The default location of P1 is the lower-left corner of the PCL Picture Frame; the default location of P2 is the upper-right corner, as shown in Figure 19-9. (The default picture frame extends from the top margin to the bottom margin, and from the left edge to the right edge of the logical page.)

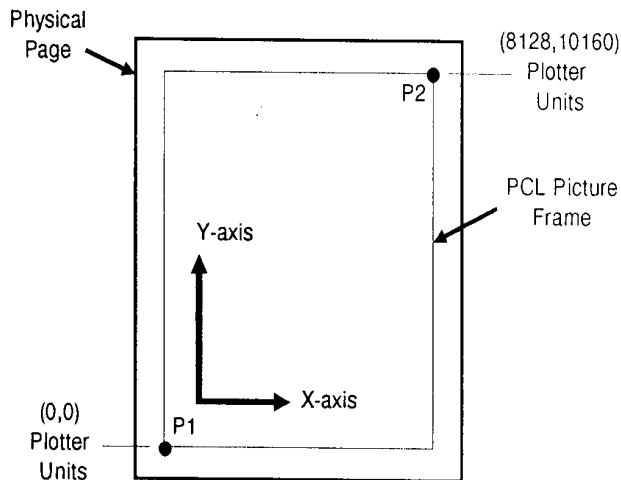

Figure 19-9 The Default P1/P2 Locations

- **No Parameters** — Sets P1 and P2 to their default locations, adjusted by any current axis rotation.

Note

If an IP command without parameters is executed after the axes are rotated with the RO command, P1 and P2 locations change to reflect the rotation. If the coordinate system orientation subsequently changes (e.g., by sending an RO command), the plotter unit position is maintained with respect to the new orientation.

- **X,Y Coordinates** — Specify the location of P1 (and, optionally, P2) in plotter units. Specifying P2 is not required. If P2 is not specified, P2 tracks P1 and its coordinates change so that the X,Y distances between P2 and P1 stay the same. This tracking process can locate P2 outside the effective window. Used carefully, the tracking function can be useful for preparing more than one equal-sized drawing on a page. For an example, refer to “Drawing Equal-Sized Pictures on a Page” earlier in this chapter.
- Neither X,Y coordinate of P1 can equal the corresponding coordinate of P2. If either coordinate of P1 equals the corresponding coordinate of P2, the coordinate of P2 is incremented by 1 plotter unit.

The locations of P1 and P2 interact with the following commands:

Table 19-11 Commands Affected by P1/P2

Command	Group
IW, Input Window RO, Rotate Coordinate System SC, Scale	<i>The Configuration/Status Group</i>
FT, Fill Type LT, Line Type PW, Pen Width WU, Pen Width Unit Selection	<i>The Line and Fill Attributes Group</i>
DR, Relative Direction LB, Label SR, Relative Character Size	<i>The Character Group</i>

An IP command remains in effect until another IP command is executed, an IR command is executed, or the printer is initialized.

Table 19-12

Related Commands	Group
IR, Input Relative P1 and P2	<i>The Configuration/Status Group</i>
IW, Input Window	
RO, Rotate Coordinate System	
SC, Scale	

IR, Input Relative P1 and P2

This command establishes new or default locations for the scaling points P1 and P2 relative to the PCL Picture Frame size. P1 and P2 are used by the Scale (SC) command to establish user-unit scaling. IR can also be used in advanced techniques such as printing mirror-images, enlarging/reducing drawings, and enlarging/reducing relative character size, or changing label (text) direction.

IR $X_{P1}, Y_{P1}, [X_{P2}, Y_{P2};]$ or

IR $[:]$

Parameter	Format	Functional Range	Default
$X_{P1}Y_{P1}[X_{P2}Y_{P2};]$	clamped real	0 to 100%	0,0,100,100%

When P1 and P2 are set using IR, the scaled area is page size-independent. As the PCL Picture Frame changes size, P1 and P2 keep the same relative position within the PCL Picture Frame boundaries.

- **No Parameters** — Defaults P1 and P2 to the lower-left and upper-right corners of the PCL Picture Frame, respectively.
- **X,Y Coordinates** — Specify the location of P1 (and, optionally, P2) as percentages of the PCL Picture Frame limits (specifying P2 is not required). If P2 is not specified, P2 tracks P1; the P2 coordinates change so that the distances of X and Y between P1 and P2 remain the same. This tracking process can cause P2 to locate outside the effective window. Used carefully, the tracking function can be useful for preparing more than one equal-sized drawing on a page. For an example, refer to “Drawing Equal-Sized Pictures on a Page” earlier in this chapter.
- Neither X,Y coordinate of P1 can equal the corresponding coordinate of P2. If either coordinate of P1 equals the corresponding coordinate of P2, the coordinate of P2 is incremented by 1 plotter unit.

Sending the command **IR25,25,75,75** establishes new locations for P1 and P2 that create an area half as high and half as wide as the PCL Picture Frame, in the center of the picture frame. Refer to the following illustration.

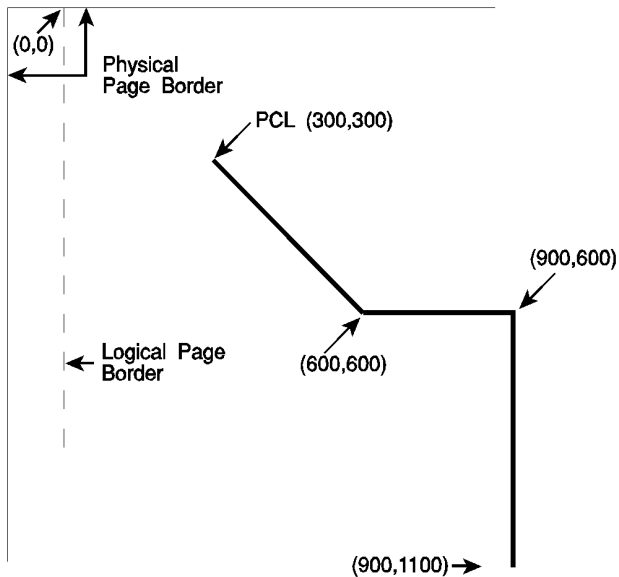

Figure 19-10 Example: P1 and P2 command

P1 or P2 can also be set outside the PCL Picture Frame by specifying parameters less than zero and greater than 100. For example, sending (IR-50,0,200,100) would set P1 and P2 as shown in the following illustration.

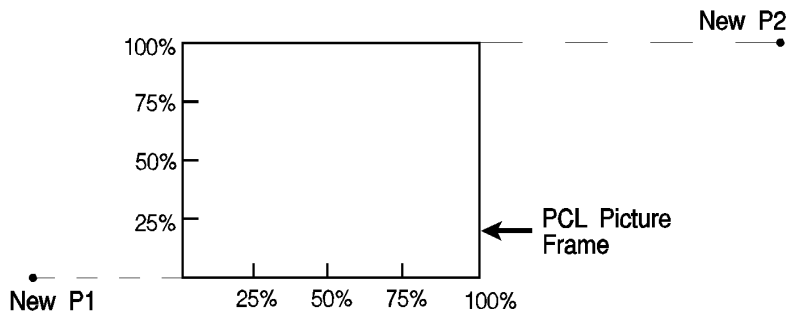

Figure 19-11 Example: P1 and P2 command

If you specify P1 and P2 beyond the PCL Picture Frame, your drawing is scaled with respect to those locations; however, only the portion of the drawing fitting within the effective window is drawn.

Note

The specified P1/P2 percentages are converted to the equivalent plotter unit coordinates. If the coordinate system orientation subsequently changes (for example, by sending an RO command), the plotter unit position is maintained with respect to the new orientation. If an IP command without parameters is executed after the axes have been rotated with the RO command, P1 and P2 locations change to reflect the rotation.

The locations of P1 and P2 interact with the following commands:

Table 19-13 Commands Affected by P1/P2

Command	Group
IW, Input Window RO, Rotate Coordinate System SC, Scale	<i>The Configuration/Status Group</i>
FT, Fill Type LT, Line Type PW, Pen Width WU, Pen Width Unit Selection	<i>The Line and Fill Attributes Group</i>
DR, Relative Direction LB, Label SR, Relative Character Size	<i>The Character Group</i>

An IR command remains in effect until another IR command is executed, an IP command is executed, or the printer is initialized.

Table 19-14

Related Commands	Group
IP, Input P1 and P2 IW, Input Window RO, Rotate Coordinate System SC, Scale	<i>The Configuration/Status Group</i>

IW, Input Window

This command defines a rectangular area, or window, that establishes soft-clip limits. Subsequent HP-GL/2 drawing is restricted to this area. Use IW to restrict printing to a specified area on the page.

IW $X_{LL}, Y_{LL}, X_{UR}, Y_{UR}[:]$ or

IW $[:]$

Parameter	Format	Functional Range	Default
$X_{LL}, Y_{LL}, X_{UR}, Y_{UR}$	current units	-2^{30} to $2^{30} - 1$	PCL Picture Frame

The printer interprets the command parameters as follows.

- **No Parameters** — Resets the soft-clip limits to the PCL Picture Frame limits.
- **X,Y Coordinates** — Specify the opposite, diagonal corners of the window area, usually the lower-left (LL) and upper-right (UR) corners. Coordinates are interpreted in the current units: as user-units when scaling is on; as plotter units when scaling is off.

When scaling is on, subsequent changes to P1 and P2 move the window in relation to the physical page, but keep the same user coordinate locations. However, sending a subsequent SC command binds the window to its equivalent plotter units. The window does not change with any subsequent IP or IR commands.

When you turn on the printer, the window is automatically set to the PCL Picture Frame boundaries. You can define a window that extends beyond the picture frame, however the printer cannot print vector graphics beyond the effective window. All programmed pen motion is restricted to this area. For more information, refer to “Windowing: Setting Up Soft-Clip Limits” at the beginning of this chapter.

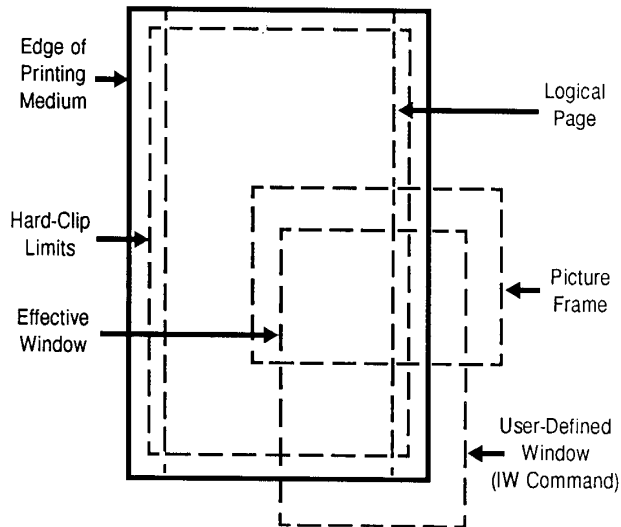

Figure 19-12 The Effective Window

If the window falls entirely outside of the PCL Picture Frame, no image is drawn. The IW command remains in effect until another IW command is executed, or the printer is initialized or set to default conditions.

The following example draws a label, then establishes a window and again draws the label along with a line. Notice how the line and label are clipped after the window is established, but not before.

Table 19-15 Example: The IW Command

$E_C E$	Reset the printer.
$E_C \%1B$	Enter HP-GL/2 mode.
IN;	Initialize HP-GL/2 mode.

Table 19-15 Example: The IW Command (continued)

SP1;	Select pen number 1. Even though there is no physical pen, the SP command must be used to enable printing.
SI.2,.35;	Set Absolute Character Size to .2 x .35 cm.
PA2000,3200;	Specify absolute plotting and move to location (2000,3200) (plotter units).
DT@,1;	Define label terminator to be the "@" character, without printing the character.
LBTHIS IS AN EXAMPLE OF IW@;	Print a label beginning at (2000,3200). (The label on the left is shown on two lines—with a Carriage Return in the middle of the text—for convenience in this example. In an actual command sequence, this label text should be all on one line to print as shown in the plot at the end of this example.)
IW3000,1300,4500,3700;	Specify a soft-clip window (in plotter units).
PD2000,1700	Pen Down; print a line from the current pen position to (2000,1700). Current pen position at start of command is at the letter W baseline.
LBTHIS IS AN EXAMPLE OF IW@;	Print the same label at (2000,1700). (This label should not contain carriage returns to print as shown in the plot for this example.)
PU3000,1300;	Pen Up and move to position (3000,1300).
PD4500,1300,4500,3700;	Pen Down and begin drawing box indicating the soft-clip window.
PD3000,3700,3000,1300;	Finish drawing the soft-clip window box
PU;	Pen Up
E _C %0A	Enter PCL Mode.
E _C E	Reset the printer to end the job and eject the page.

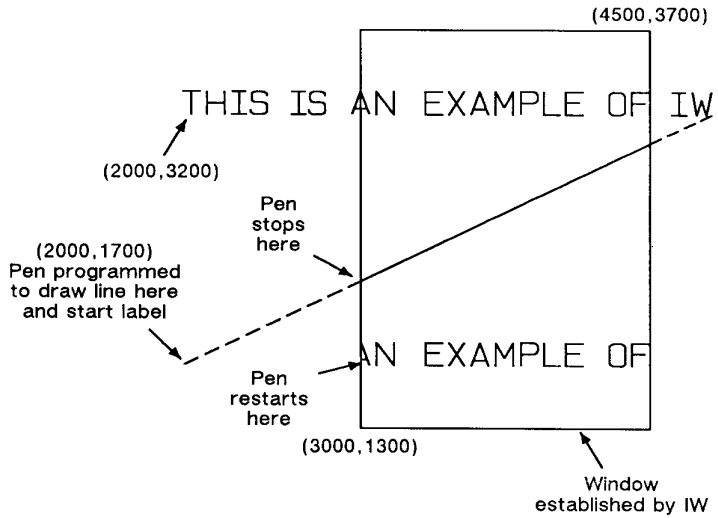

Figure 19-13 Example: IW command

Table 19-16

Related Commands	Group
IP, Input P1 and P2 IR, Input Relative P1 and P2 RO, Rotate Coordinate System SC, Scale	<i>The Configuration/Status Group</i>

PG, Advance Full Page

This HP-GL/2 command is ignored by the printer since it could cause undesirable results when importing plots. A page eject can be accomplished only from the PCL printer language mode.

The following PCL commands cause a conditional page eject, meaning that a page is ejected if there is any printable data in the print buffer:

- $E_C E$ Reset
- UEL (Universal Exit Language)
- Flush All Pages
- Page Length
- Page Size
- Orientation
- Paper Source

When a page is ejected using one of the above commands, the PCL cursor position is set to the top of form on the new page. (The Top of Form is 3/4 of a line below the top margin.)

An alternative method of ejecting a page from PCL is the Form Feed control code. A Form Feed causes an unconditional page eject and advances the current active cursor position to the top of form on the next page. The horizontal cursor position remains the same as before the page eject.

Note

The HP-GL/2 pen position is not affected by a Form Feed; it occupies the same position on the next page.

RO, Rotate Coordinate System

This command rotates the printer's coordinate system relative to the default HP-GL/2 coordinate system, in the following increments of rotation: 90°, 180°, and 270°. Use RO to orient your drawing vertically or horizontally, or to reverse the orientation.

RO *angle[:]* or

RO *[:]*

Parameter	Format	Functional Range	Default
angle	clamped integer	0°, 90°, 180°, or 270°	0°

The printer interprets the command parameters as follows:

- **No Parameter** — Defaults the orientation of the coordinate system to 0°. Equivalent to (RO0). This is the same as PCL's current orientation.

- **Angle** — Specifies the degree of rotation:

0 Sets the orientation to PCL's current orientation.

90 Rotates and shifts the coordinate system 90 degrees in a positive angle of rotation from PCL's current orientation.

180 Rotates and shifts the coordinate system 180 degrees in a positive angle of rotation from PCL's current orientation.

270 Rotates and shifts the coordinate system 270 degrees in a positive angle of rotation from PCL's current orientation.

Angle of Rotation

Note

A *positive angle* of rotation is in the direction of the +X-axis to the +Y-axis as shown below. (A *negative angle* of rotation is not allowed in the RO command.)

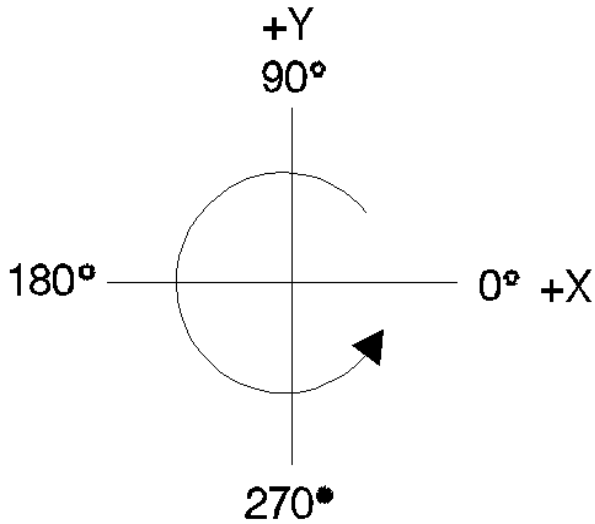

Figure 19-14 Angle of rotations

Note

The relationship of the X-axis to Y-axis can change as a result of the scaling point or scaling factor changes, thus changing the direction of a positive angle of rotation.

The physical location of the pen does not change when you rotate the coordinate system. The printer updates the pen's X,Y coordinate location to reflect the new orientation.

The scaling points P1 and P2 rotate with the coordinate system. However, they maintain the same X,Y coordinate values as before the rotation. This means that P1 and P2 can be located outside of the PCL Picture Frame. Follow the *(RO90)* or *(RO270)* commands with *(IP)* or *(IR)* to relocate points P1 and P2 to the lower-left and upper-right corners of the picture frame.

When the RO command is used, the soft-clip window, if defined, is also rotated, and any portion that is rotated outside of the picture frame is clipped to the picture frame boundaries. The soft-clip window can be set equal to the picture frame by issuing an "IW;" command (see Figure 19-17).

Note

The RO command also rotates the contents of the polygon buffer.

The RO command remains in effect until the rotation is changed by another RO command, or the printer is initialized.

Figure 19-15 shows the default orientation and the result of rotating the orientation without relocating P1 and P2.

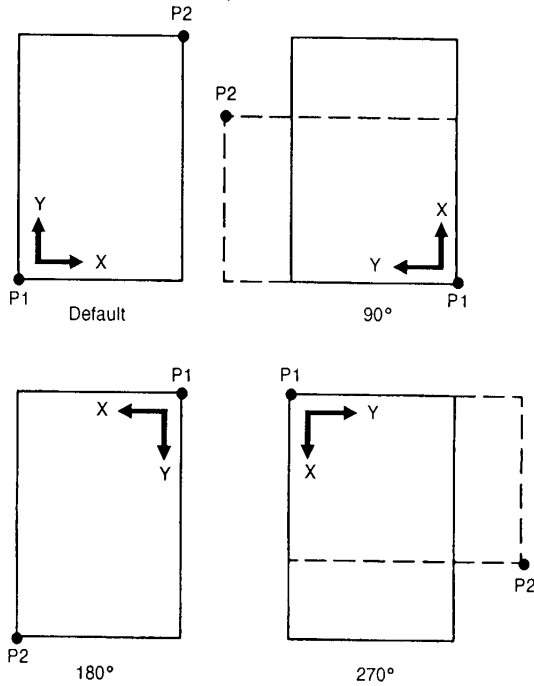

Figure 19-15 Using the RO Command Without Using the IP Command

Figure 19-16 shows the locations of P1 and P2 when you follow the rotation with the IP command.

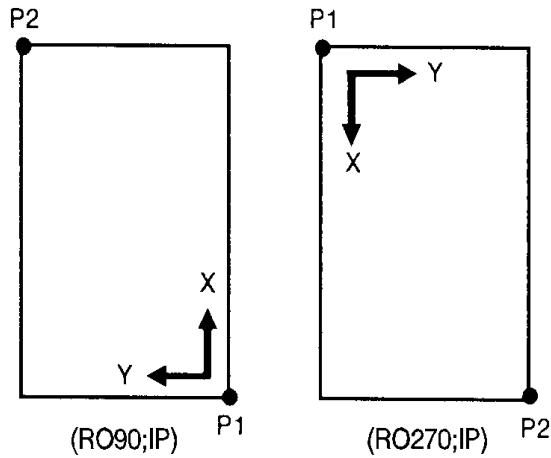

Figure 19-16 Using IP after the RO Command

When you set-up a soft-clip window (see the IW command), RO also rotates the window. If a portion of a window rotates outside the hard-clip limits, it is clipped. Note that *IP* does not affect the window limits. Use *IW* to reset the window to the size of the PCL Picture Frame.

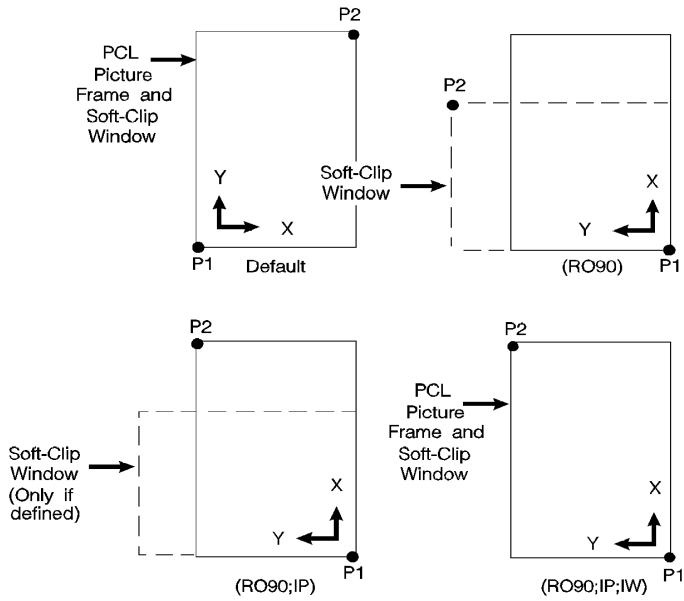

Figure 19-17 Using IP and IW after the RO Command

Table 19-17

Related Commands	Group
IP, Input P1 and P2 IR, Input Relative P1 and P2 IW, Input Window	<i>The Configuration/Status Group</i>

RP, Replot

This command is ignored by the printer; to eject a page, the printer must be in PCL printer language mode. The following commands cause a conditional page eject; a page is ejected if there is any printable data in the print buffer:

- $E_C E$ Reset
- UEL (Universal Exit Language)
- Flush All Pages
- Page Length
- Page Size
- Orientation
- Paper Source

The PCL Form Feed control code causes an unconditional page eject and advances the cursor position to the top of form on the next page.

Note

A page eject caused by any of the above commands except Paper Source defaults the HP-GL/2 pen position.

To print more than one plot, use the Number of Copies command. For information about printing more than one copy of an HP-GL/2 illustration, see “Number of Copies Command” in Chapter 4.

SC, Scale

This command establishes a user-unit coordinate system by mapping user-defined coordinate values onto the scaling points P1 and P2.

SC *XMIN, XMAX, YMIN, YMAX* [*, type[, left, bottom;]*] or

SC *XMIN, XFACTOR, YMIN, YFACTOR, type[:]* or

SC *[:]*

Parameter	Format	Functional Range	Default
X_{MIN}, X_{MAX}	real	-2^{30} to $2^{30} - 1$	no default
Y_{MIN}, Y_{MAX}	real	-2^{30} to $2^{30} - 1$	no default
type	clamped integer	0, 1, or 2	0
left	clamped real	0 to 100%	50%
bottom	clamped real	0 to 100%	50%
X_{FACTOR}, Y_{FACTOR}	real	-2^{30} to $2^{30} - 1$	no default

For more information about the basic concept of scaling, refer to “The Scale Command” earlier in this chapter.

There are three forms of scaling: anisotropic, isotropic, and point-factor. The *Type* parameter tells the printer which form you are using. Refer to the following table.

Table 19-18

Scaling Form	Type	Description
Anisotropic	0	Establishes standard user-unit scaling allowing different unit size on X-axis and Y-axis.
Isotropic	1	Establishes standard user-unit scaling with same unit size on X-axis and Y-axis.
Point Factor	2	Establishes P1 user-unit location and a specific ratio of plotter units to user-units.

- **No Parameters** — Turns off scaling; subsequent coordinates are in plotter units.

For Scaling Types 0 and 1:

The following forms of scaling establish a user-unit coordinate system by mapping user-defined coordinate values onto the scaling points P1 and P2. The type parameter selects between anisotropic (Type 0) and isotropic scaling (Type 1).

Table 19-19

Scaling Form	Type	Syntax
Anisotropic	0	SC XMIN, XMAX, YMIN, YMAX[, type;]
Isotropic	1	SC %%X _{MIN} , X _{MAX} , Y _{MIN} , Y _{MAX} [, type [, left, bottom];]

- X_{MIN} , X_{MAX} , Y_{MIN} , Y_{MAX} — These parameters represent the user-unit X- and Y-axis ranges, respectively. For example, *SC0,15,0,10* indicates 15 user-units along the X-axis and 10 user-units along the Y-axis. As a result, the first and third parameters (X_{MIN} and Y_{MIN}) are the coordinate pair that is mapped onto P1; the second and fourth parameters (X_{MAX} and Y_{MAX}) are the coordinate pair mapped onto P2. Using the same example, the coordinate location of P1 is (0,0) and P2 is (15,10). This is different from the IP command, where the parameters are expressed as X,Y coordinate pairs rather than as ranges.

Note

X_{MIN} cannot be set equal to X_{MAX} , and Y_{MIN} cannot be set equal to Y_{MAX} .

As their names suggest, you will normally want to specify X_{MIN} smaller than X_{MAX} , and Y_{MIN} smaller than Y_{MAX} . If you specify X_{MIN} larger than X_{MAX} and Y_{MIN} larger than Y_{MAX} , your illustration is drawn as a mirror-image, reversed and/or upside down, depending on the relative positions of P1 and P2.

The parameters of the SC command are always mapped onto the current P1 and P2 locations. P1 and P2 retain these new values until scaling is turned off or another SC command redefines the user-unit values. Thus, the size of a user unit could change if any change is made in the relative position and distance between P1 and P2 *after* an SC command is executed.

- **Type** — Specifies anisotropic or isotropic scaling.

Table 19-20

- | | |
|----------|---|
| 0 | Anisotropic scaling. Allows a user-unit along the X-axis to be a different size than user-units along the Y-axis. Printed shapes are distorted when you use anisotropic scaling. For example, a circle might be drawn as an ellipse—oval-shaped instead of round. (<i>Left and bottom</i> parameters are ignored for anisotropic scaling.) |
| 1 | Isotropic scaling. Produces user-units that are the same size on both the X- and Y-axes. The following illustrations show how the printer adjusts the location of (X_{MIN}, Y_{MIN}) and (X_{MAX}, Y_{MAX}) to create the largest possible isotropic area within the P1/P2 limits. (Remember, the user-units are always square regardless of the shape of the isotropic area.) |

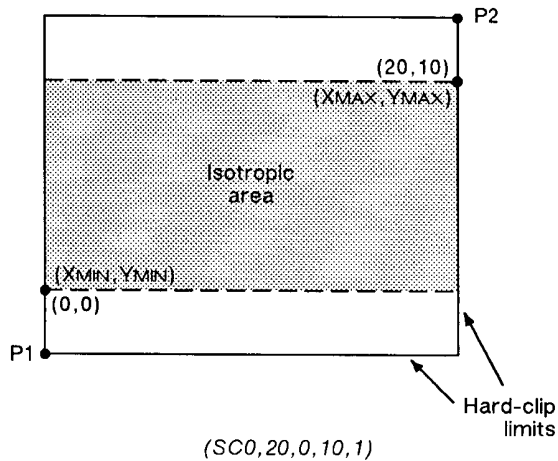
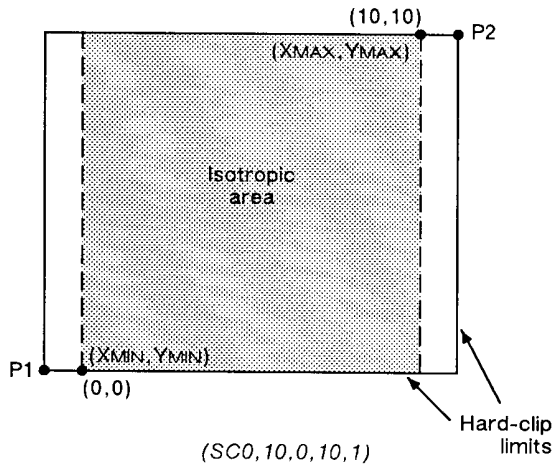

Figure 19-18 Isotropic Scaling

- **Left, Bottom** — Positions the isotropic area in the P1/P2 limits. (These parameters are always specified together and are valid for isotropic scaling only.) The left parameter indicates the percentage of the unused space on the left of the isotropic area; the bottom parameter indicates the percentage of unused space below.
- The defaults for the left and bottom parameters are each 50%. This centers the isotropic area on the page with the unused space equally divided between left and right or top and bottom, as shown in the previous illustrations.

- Although you **must** specify both parameters, the printer applies only one: the left parameter applies when there is extra horizontal space; the bottom parameter applies when there is extra vertical space. The following examples illustrate left and bottom parameters of 0% and 100%.

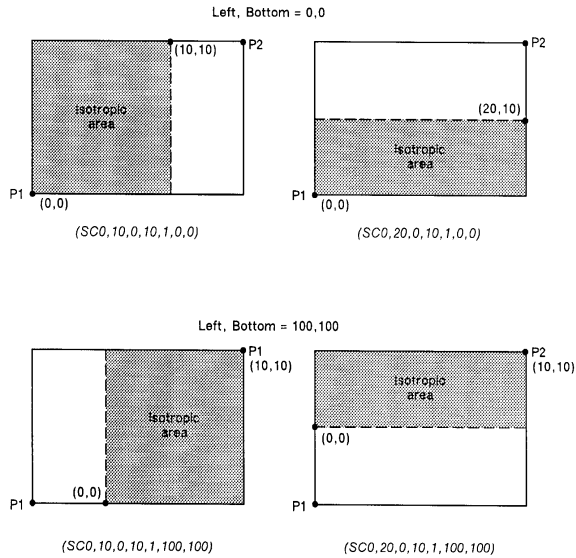

Figure 19-19 The Left and Bottom Parameters

For Scaling Type 2:

The third form of scaling, point-factor scaling, sets a specific ratio of plotter units to user-units, and establishes the user-units coordinate of P1.

Table 19-21

Scaling Form	Type	Syntax
Point Factor	2	SC X_{MIN} , X_{FACTOR} , Y_{MIN} , Y_{FACTOR} , <i>type</i> [:]

- $X_{MIN}, X_{FACTOR}, Y_{MIN}, Y_{FACTOR}$ — Establish the user-unit coordinates of P1 and the ratio of plotter to user-units. X_{MIN} and Y_{MIN} are the user-unit coordinates of P1. X_{FACTOR} sets the number of plotter units per user-unit on the X-axis; Y_{FACTOR} sets the number of plotter units per user-unit on the Y-axis.
- **Type** — Must be 2 for this type of scaling.

An SC command remains in effect until another SC command is executed, or the printer is initialized or set to default conditions.

Examples: The following examples explain the effect of several parameter selections.

(SC0,40,0,40,2) allows scaling in millimeters since 1 millimeter = 40 plotter units. Each user-unit is 1 millimeter.

(SC0,1.016,0,1.016,2) allows scaling in thousandths of an inch since 1 inch = 1016 plotter units.

While scaling is on (after any form of the SC command has been executed), only those HP-GL/2 commands that can be issued in 'current units' are interpreted as user-units; the commands that can be issued only in plotter units are still interpreted as plotter units. (The command syntax discussion pertaining to each command tells you which kind of units each parameter requires.)

The SC parameters are mapped onto the current locations of P1 and P2. P1 and P2 do *not* represent a graphic limit; therefore, the new user-unit coordinate system extends across the entire range of the plotter-unit coordinate system. Thus, you can print to a point beyond P1 or P2, as long as you are within the effective window. For example, you can print from the point (-1,3.5) to the point (5.5,1.5) as shown in the following illustration.

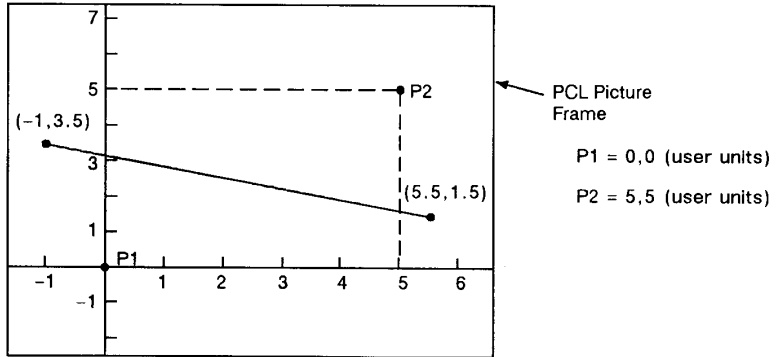

Figure 19-20 Example: Printing point-to-point

Table 19-22

Related Commands	Group
IP, Input P1 and P2 IR, Input Relative P1 and P2 IW, Input Window	The Configuration/Status Group

Table 19-23 Possible Error Conditions for SC

Condition	Printer Response
no parameters	turns scaling off
more than 7 parameters	executes first 7 parameters
for types 0 or 1: 6 parameters or less than 4 parameters	ignores command
for type 2: any more or less than 5 parameters	ignores command
$X_{MIN}=X_{MAX}$ or $Y_{MIN}=Y_{MAX}$ or number out of range	ignores command
$X_{FACTOR}=0$ or $Y_{FACTOR}=0$	ignores command

20 The Vector Group

Introduction

The information in this chapter enables you to achieve the following results in your programs:

- Use absolute and relative coordinates when plotting.
- Draw lines, arcs, bezier curves, and circles.
- Encode coordinates to increase your printer's throughput.

The following commands are described in this chapter.

Table 20-1 The Vector Group Commands

Command	Summary
AA, Arc Absolute	Draws an arc using absolute coordinates.
AR, Arc Relative	Draws an arc using relative coordinates.
AT, Absolute Arc Three Point	Draws an arc from the current pen location through two absolute points.
BR, Bezier Relative	Draws a bezier curve using relative coordinates as control points.
BZ, Bezier Absolute	Draws a bezier curve using absolute coordinates as control points.
CI, Circle	Draws a circle with a specified radius.

Table 20-1 The Vector Group Commands (continued)

PA, Plot Absolute	Enables movement to absolute coordinate locations (with respect to the origin [0,0]).
PD, Pen Down	Lowers the "pen" to the page.
PE, Polyline Encoded	Increases throughput by encrypting common HP-GL/2 commands.
PR, Plot Relative	Enables movement relative to the current pen location.
PU, Pen Up	Lifts the pen from the page.
RT, Relative Arc Three Point	Draws an arc from the current pen location through two relative points.

Drawing Lines

You can draw lines between two points (X,Y coordinate pairs) using the PD (Pen Down) command and a series of absolute and/or relative coordinate pairs. The printer draws only the portion of the line that falls within the *effective window*.

Note

When using HP-GL/2 to draw lines, you can increase your printer's throughput by using the Polyline Encoded (PE) command to send coordinates. The PE command requires that you convert coordinates from decimal to base 64 or 32. This conversion especially increases throughput when using a serial interface. The PE command, with its parameters, is used in place of the PA, PD, PR, and PU commands.

In the following example, note that the PA (Plot Absolute) command specifies absolute plotting, and the coordinate pair (0,0) sets the beginning pen location.

Table 20-2 Example: Drawing Lines

$E_C E$	Reset the printer.
$E_C \% \emptyset B$	Enter HP-GL/2 mode.
IN;	Initialize HP-GL/2 mode.
SP1;	Select pen number 1 (black). You must use the SP command to be able to print HP-GL/2 images.
PA0,0;	Begin absolute plotting from coordinate (0,0).
PD2500,0,0,1500,0,0;	Specify Pen Down and draw lines between the points.
$E_C \% \emptyset A$	Enter the PCL mode.
$E_C E$	Send a reset to end the job and eject the page.

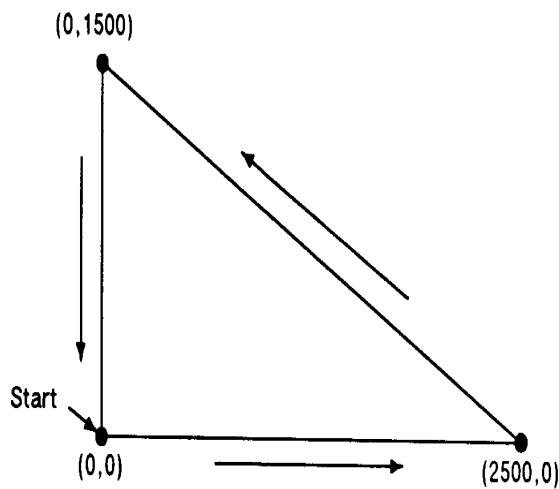

Figure 20-1 Drawing lines

Note

Any line drawn along the border of the effective window causes the line to be clipped, producing a line width of one-half of what it should be. For example, in the above plot, the lines from (0,0) to (0,1500), and (0,0) to (2500,0) is clipped.

Drawing Circles

The Circle (CI) command uses your current pen position as the center of the circle; you specify the radius of the circle.

The following example shows a simple command sequence using CI to draw a circle with a radius of 500 plotter units.

Table 20-3 Example: Drawing Circles

$E_C E$	Reset the printer.
$E_C \% \emptyset B$	Enter HP-GL/2 mode.
IN;	Initialize HP-GL/2.
SP1;	Select pen number 1. The SP command must be used to enable printing.
PA2400,2500;	Specify absolute plotting and move to position (2400,2500).
CI500;	Draw a circle with a radius of 500 plu (plotter units); the center of the circle is the current pen location (2400,2500).
$E_C \% \emptyset A$	Enter the PCL mode.
$E_C E$	Send a reset to end the job and eject the page.

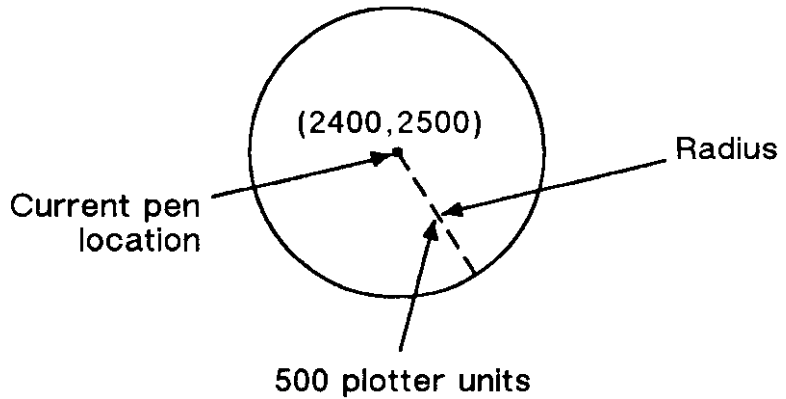

Figure 20-2 Drawing circles

Drawing Arcs

The Arc Absolute (AA) and Arc Relative (AR) commands use the following method for drawing arcs. Your current pen location becomes one end of the arc; you specify the center point with one parameter (setting the radius), and set another parameter to specify the number of degrees through which you want the arc drawn.

The following illustration shows a simple command sequence using the AA command to draw a circle and an arc:

Table 20-4 Example: Drawing Arcs

<code>E_CE</code>	Reset the printer.
<code>E_C%ØB</code>	Enter HP-GL/2 mode.
<code>IN;</code>	Initialize HP-GL/2.
<code>SP1;</code>	Select pen number 1. Even though there is no physical pen, the SP command must be used to enable printing.
<code>PA4200,2900;PD;</code>	Set starting point to (4200,2900) and set pen down.

Table 20-4 Example: Drawing Arcs

AA4600,2500,-180;	Using the Arc Absolute command, specify the pivot point of the arc, thereby setting the radius; draw the arc for 180° in a <i>negative</i> angle of rotation.
E _C %ØA	Enter the PCL mode.
E _C E	Send a reset to end the job and eject the page.

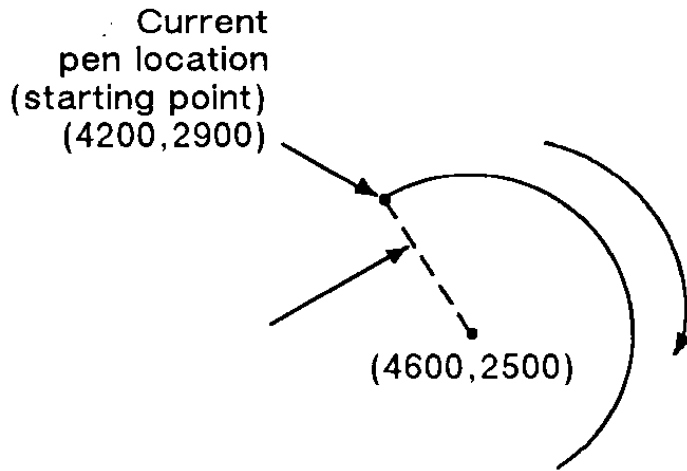

Figure 20-3 Drawing arcs (1 of 3)

Angle of Rotation

NoteS

A *positive angle* of rotation is in the direction of the +X-axis to the +Y-axis as shown below.

A *negative angle* of rotation is in the direction of the +X-axis to the -Y-axis.

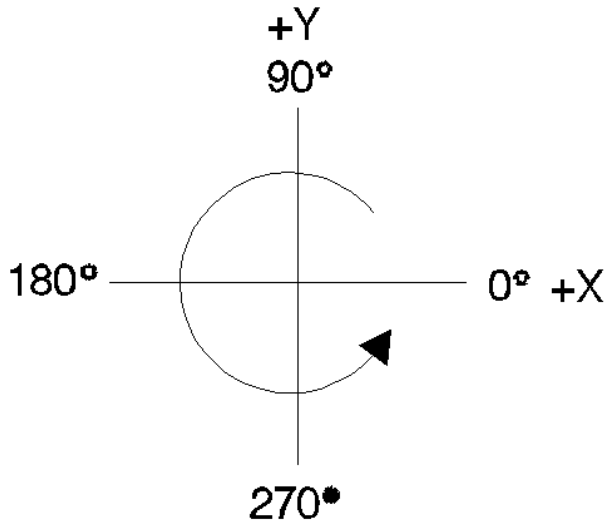

Figure 20-4 Drawing arcs (2 of 3)

Note

The relationship of the +X-axis to +Y-axis (and -Y-axis) can change as a result of the scaling point or scaling factor changes, thus, changing the direction of a positive (or negative) angle of rotation.

You can also draw arcs using the Absolute Arc Three Point (AT) and Relative Arc Three Point (RT) commands. These commands use three known points (your current pen location plus two points you specify) to calculate a circle and draw the appropriate arc segment of its circumference. The arc is drawn with a positive angle of rotation, so that it passes through the intermediate point before the end point. Refer to the following illustration.

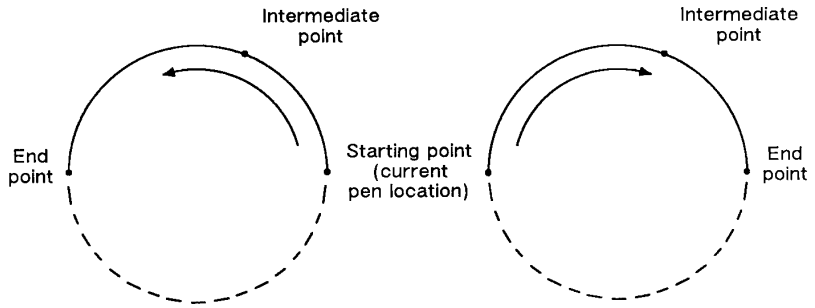

Figure 20-5 Drawing arcs (3 of 3)

Drawing Bezier Curves

The Bezier Absolute (BZ) and Bezier Relative (BR) commands use your current pen position as the first control point in the Bezier curve. You specify the second, third, and fourth control points. If you are drawing more than one curve, the fourth control point of the first curve (X_3, Y_3) becomes the first control point of the next curve.

The following example shows a simple command sequence using BZ to draw a Bezier Curve in the shape of a sine wave (shown in the figure following the example).

Table 20-5 Example: Drawing Bezier Curves

$E_C E$	Reset the printer.
$E_C \% \emptyset B$	Enter HP-GL/2 mode.
IN;	Initialize HP-GL/2.
SP1;	Select pen number 1. The SP command must be used to enable printing.
PA1000,5000;PD;	Specify absolute plotting and move to position (1000,5000); pen down.
BZ2000,8000, 4000,2000,5000,5000;	Draw a Bezier curve with (1000,5000) as the starting point (first control point). Specify (2000,8000), (4000,2000), and (5000,5000) as the second, third, and fourth control points.
$E_C \% \emptyset A$	Enter the PCL mode.

Table 20-5 Example: Drawing Bezier Curves (continued)

E _C E	Send a reset to end the job and eject the page.
------------------	---

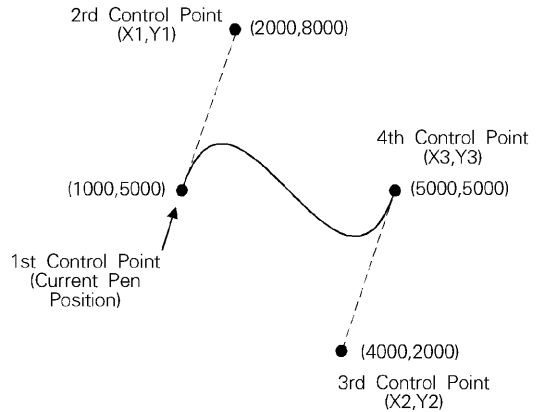

Figure 20-6 Bezier Curves

AA, Arc Absolute

This command draws an arc, using absolute coordinates, which starts at the current pen location and pivots around the specified center point.

AA $X_{center}, Y_{center}, sweep\ angle[, chord\ angle;]$

Parameter	Format	Functional Range	Default
X_{center}, Y_{center}	current units	-2^{30} to $2^{30} - 1$	no default
sweep angle	clamped real	-32768 to 32767	no default
chord angle	clamped real	0.5° to 180°	5°

The AA command draws an arc starting at the current pen location using the current pen up/down status and line type and attributes. After drawing the arc, the pen location remains at the end of the arc.

Note

Do *not* use an adaptive line type when drawing arcs with small chord angles. The printer attempts to draw the complete pattern in every chord (there are 72 chords in a circle using the default chord angle).

- **XCenter, YCenter** — Specify the absolute location of the center of the arc. (The center of the arc is the center of the circle that would be drawn if the arc was 360 degrees.)
- Coordinates are interpreted in current units: as user-units when scaling is on; as plotter units when scaling is off. If current scaling is not isotropic, the arc drawn is elliptical rather than circular.
- **Sweep Angle** — Specifies in degrees the angle through which the arc is drawn. A positive angle is drawn in a positive direction (angle of rotation); a negative angle is drawn in the negative direction.
- **Chord Angle** — Specifies the chord angle used to draw the arc. The default is a chord angle of 5 degrees. The chord angle specifies, in degrees, the maximum angle created when lines from each end of the chord intersect the center point of the circle (see drawing below). The smaller the chord angle, the smoother the curve.

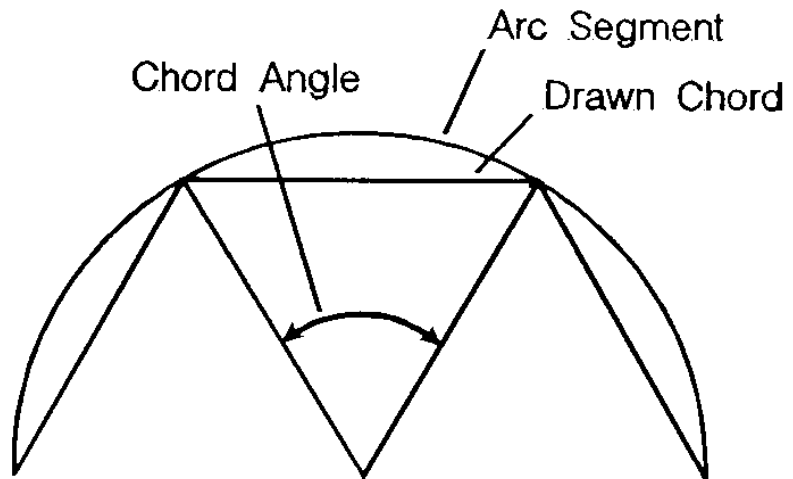

Figure 20-7 Chord Angle

- For a specific chord angle, a circle or arc always has the same number of chords, regardless of its size. For example, for the default chord angle, a circle is always composed of 72 chords ($360^\circ/5^\circ$ per chord = 72 chords). This results in larger circles appearing less smooth than smaller circles with the same chord angle; setting the chord angle to a smaller number will help large circles or arcs appear more smooth (see Figure 20-8).

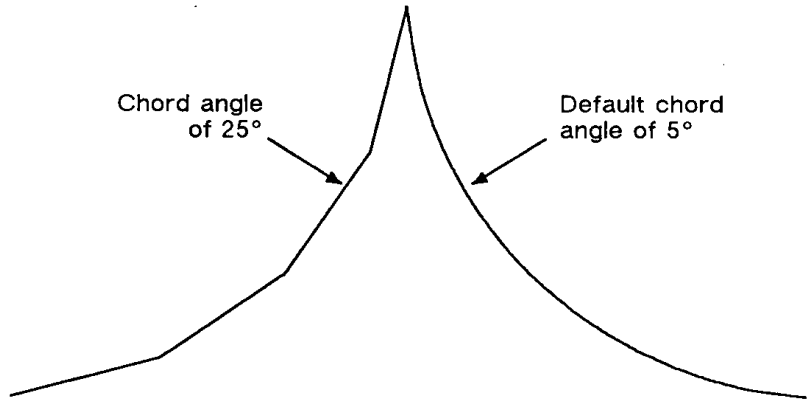

Figure 20-8 Changing Arc Smoothness with the Chord Angle

Table 20-6 Example: Varying the Chord Angle

E_{CE}	Reset the printer.
$E_C\%ØB$	Enter HP-GL/2 mode.
IN;	Initialize HP-GL/2 mode.
SP1;	Select pen number 1. Even though there is no physical pen, the SP command must be used to enable printing.
PA2000,0;	Specify (2000,0) as the starting point.
PD;AA0,0,45,25;	With the pen down, draw a 45° arc (positive angle) with center coordinates of (0,0) and a chord angle of 25° .
PU1050,1060;	Lift the pen and move to (1050,1060).
PD;AA0,0,-45,10;	With the pen down, draw a 45° arc (negative angle) using the same center point as the first arc, but with a 10° chord angle.

Table 20-6 Example: Varying the Chord Angle (continued)

PU1000,0;	Lift the pen and move to (1000,0).
PD;AA0,0,45;	With the pen down, draw another 45° arc (positive angle) with the same center point, but with the default chord angle (5°).
E _C %ØA	Enter the PCL mode.
E _C E	Send a reset to end the job and eject the page.

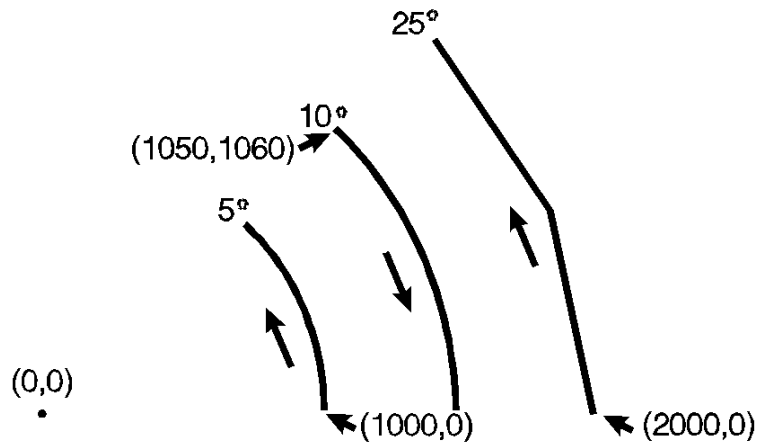

Figure 20-9

Table 20-7

Related Commands	Group
AT, Absolute Arc Three Point	<i>The Vector Group</i>
BR, Bezier Relative	
BZ, Bezier Absolute	
AR, Arc Relative	
CI, Circle	
RT, Relative Arc Three Point	

Table 20-7

LA, Line Attributes	<i>The Line and Fill Attributes Group</i>
LT, Line Type	
PW, Pen Width	

AR, Arc Relative

This command draws an arc, using relative coordinates, which starts at the current pen location and pivots around the specified center point.

AR $X_{\text{increment}}, Y_{\text{increment}}, \text{sweep angle}[\text{chord angle};]$

Parameter	Format	Functional Range	Default
$X_{\text{increment}}, Y_{\text{increment}}$	current units	-2^{30} to $2^{30} - 1$	no default
sweep angle	clamped real	-32768 to 32767	no default
chord angle	clamped real	0.5° to 180°	5°

The AR command draws the arc starting at the current pen location using the current pen up/down status, line type, and attributes. After drawing the arc, the pen location remains at the end of the arc.

Note

Do *not* use an adaptive line type when drawing arcs with small chord angles. The printer attempts to draw the complete pattern in every chord (there are 72 chords in a circle using the default chord angle).

- $X_{\text{Increment}}, Y_{\text{Increment}}$** — Specify the center of the arc relative to the current location. (The center of the arc is the center of the circle that would be drawn if the arc was 360 degrees.)
 Coordinates are interpreted in current units: as user-units when scaling is on; as plotter units when scaling is off. If current scaling is not isotropic, the arc drawn is elliptical rather than circular.

- **Sweep Angle** — Specifies (in degrees) the angle through which the arc is drawn. A positive angle draws an angle in the positive direction (angle of rotation); a negative angle draws the angle in the negative direction.
- **Chord Angle** — Specifies the chord angle used to draw the arc. The default is a chord angle of 5 degrees. Refer to the Arc Absolute (AA) command discussion (earlier this chapter) for information on setting and determining the chord angle.

Table 20-8 Example: Using Arc Relative to Draw Arcs

$E_C E$	Reset the printer.
$E_C \% \emptyset B$	Enter HP-GL/2 mode.
IN;	Initialize HP-GL/2 mode.
SP1;	Select pen number 1. Even though there is no physical pen, the SP command must be used to enable printing.
PA1500,1500;PD;	Specify the starting position as (1500,1500) and put the pen down.
AR0,2000,80,25;	Draw an arc with a center point 0 plu in the X direction and 2000 plu in the Y direction from (1500,1500). Specify the arc section to be 80° (positive angle), with a chord angle of 25°
AR2000,0,80;	Draw an arc with a center point 2000 plu in the X direction and 0 plu in the Y direction from the current pen position. Specify the arc section to be 80° (positive angle), with a default chord angle (5°).
$E_C \% \emptyset A$	Enter the PCL mode.
$E_C E$	Send a reset to end the job and eject the page.

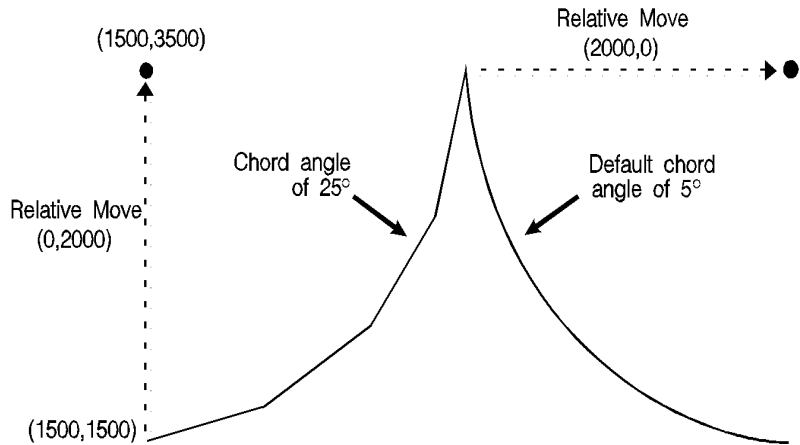

Figure 20-10

Table 20-9

Related Commands	Group
AA, Arc Absolute AT, Absolute Arc Three Point BR, Bezier Relative BZ, Bezier Absolute CI, Circle RT, Relative Arc Three Point	<i>The Vector Group</i>
LA, Line Attributes LT, Line Type PW, Pen Width	<i>The Line and Fill Attributes Group</i>

AT, Absolute Arc Three Point

This command draws an arc segment, using absolute coordinates, from a starting point, through an intermediate point, to an end point. Use AT when you know these three points of an arc.

AT *X_{inter}, Y_{inter}, X_{end}, Y_{end}[, chord angle:]*

Parameter	Format	Functional Range	Default
X _{inter} , Y _{inter}	current units	-2 ³⁰ to 2 ³⁰ - 1	no default
X _{end} , Y _{end}	current units	-2 ³⁰ to 2 ³⁰ - 1	no default
chord angle	clamped real	0.5° to 180°	5°

The AT command uses the current pen location and two specified points to calculate a circle and draw the appropriate arc segment of its circumference. The arc starts at the current pen location, using the current pen, line type, line attributes and pen up/down status. You specify the intermediate and end points. After drawing the arc, the pen location remains at the end of the arc.

- **X_{Inter}, Y_{Inter}** — Specify the absolute location of an intermediate point of the arc. The arc is drawn in a positive or negative angle of rotation, as necessary, so that it passes through the intermediate point before the end point.
- **X_{End}, Y_{End}** — Specify the absolute location of the end point of the arc.
- **Chord Angle** — Specifies the chord angle used to draw the arc. The default is a chord angle of 5°. (The Arc Absolute (AA) command description [earlier in this chapter] contains more information on chords and chord angles.)

Intermediate and end point coordinates are interpreted in current units: as user-units when scaling is on; as plotter units when scaling is off. If current scaling is not isotropic, the arc drawn is elliptical rather than circular. Note the following about locating the intermediate and end points:

- If the intermediate point and end point are the same as the current pen location, the command draws a dot.
- If the intermediate point is the same as either the current pen location or the end point, a line is drawn between the current pen location and the end point.

- If the end point is the same as the current pen location, a circle is drawn, with its diameter being the line from the current pen position to the intermediate point.
- If the current pen position, intermediate point, and end point are collinear, a straight line is drawn.
- If the intermediate point does not lie between the current pen location and the end point, and the three points are collinear, two lines are drawn; one from the current pen location and the other from the end point, leaving a gap between them. Refer to the following illustration. Both lines extend to the PCL Picture Frame limits or current window.

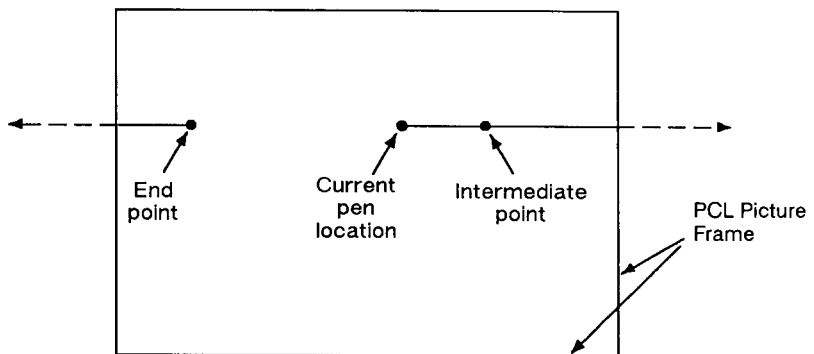

Figure 20-11

Table 20-10 Example: Using the AT Command

$E_C E$	Reset the printer.
$E_C \% \text{Ø} B$	Enter HP-GL/2 mode.
IN;	Initialize HP-GL/2 mode.
SP1;	Select pen number 1 (black).
PA1000,100; PD2500,100;	Specify (1000,100) as the starting location, place the pen down, and draw a line to (2500,100).
PU650,1150; PD1000,1150;	Lift the pen, move to (650,1150), place the pen down, and draw a line to (1000,1150).

Table 20-10 Example: Using the AT Command (continued)

PU650,450; PD1000,450;	Lift the pen, move to (650,450), place the pen down, and draw a line to (1000,450).
PU1000,100; PD1000,1500, 2500,1500;	Lift the pen, move to (1000,100), place the pen down, draw a line to (1000,1500), then to (2500,1500).
AT3200,800,2500,100;	Print an arc, starting at current pen position (2500,1500), passing through (3200,800) and ending at (2500,100).
PU3200,900;PD;	Lift the pen, move to (3200,900) and set the pen down.
AT3300,800,3200,700;	Print an arc, starting at the current pen position, passing through (3300,800) and ending at (3200,700).
PU3300,800; PD3500,800;	Lift the pen, move to (3300,800), pen down, and draw a line to (3500,800).
$E_C\%ØA$	Enter the PCL mode.
$E_C E$	Send a reset to end the job and eject the page.

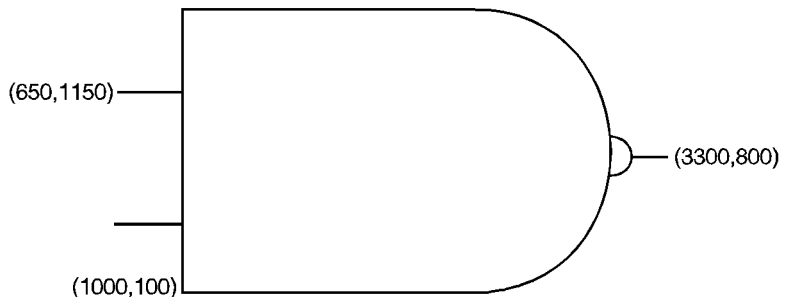

Figure 20-12

Table 20-11

Related Commands	Group
AA, Arc Absolute AR, Arc Relative BR, Bezier Relative BZ, Bezier Absolute CI, Circle RT, Relative Arc Three Point	<i>The Vector Group</i>
LA, Line Attributes LT, Line Type PW, Pen Width	<i>The Line and Fill Attributes Group</i>

BR, Bezier Relative

This command draws bezier curves using relative coordinates. This command uses the current pen position as the first control point, and specifies the other three control points as relative increments from the first point.

BR $X_1, Y_1, X_2, Y_2, X_3, Y_3, \dots [X_1, Y_1, X_2, Y_2, X_3, Y_3]$

Parameter	Format	Functional Range	Default
X_1, Y_1, \dots (control points)	current units	-2^{23} to $2^{23} - 1$	no default

The BR command uses the current pen location and three specified control points to draw a bezier curve. After each new Bezier, the last control point of the previous curve becomes the first control point of the next Bezier. All curve control points are relative to the first control point of that curve. For example, points 1, 2, and 3 of the example are relative to the starting point, while points 4, 5, and 6 are relative to point 3.

Bezier curves are drawn with the current pen, line type, current line attributes, and pen-state (up/down). The curve is clipped to the hard-clip limits and the soft-clip window. Following the command execution, the current pen position is updated to the end point of the curve.

The BR command is allowed in Polygon Mode. (The first chord after PM1 is not treated as a pen-up move.)

- **X₁, Y₁...** — Specify the location of the second (X₁, Y₁), third (X₂, Y₂), and fourth (X₃, Y₃) control points, in relative increments (relative to the first control point).

Table 20-12 Example: Using the BR Command (Bezier Relative)

E _C E	Reset the printer.
E _C %ØB	Enter HP-GL/2 mode.
IN;	Initialize HP-GL/2 mode.
SP1;	Select pen number 1. Even though there is no physical pen, the SP command must be used to enable printing.
PA1016,5080;	Specify the absolute point (1016,5080) as the starting location.
PR;PD;	Specify relative plotting and pen down.
BR0,3048,4572,0, 3556,2032,-508,1016, 2540,508,2540,-5080;	Draw a Bezier using the current position (1016,5080) as the first control point. The specified control points for the first curve are (0,3048), (4572,0), and (3556,2032). The second curve uses the last control point of the previous curve as the first control point (3556,2032). The other three control points for the second curve are (-508,1016), (2540,508), and (2540,-5080).
E _C %ØA	Enter the PCL mode.
E _C E	Send a reset to end the job and eject the page.

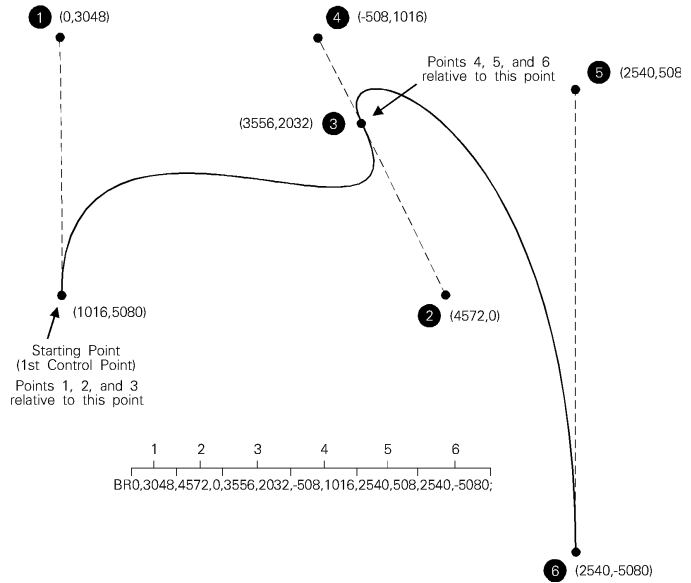

Figure 20-13

Table 20-13

Related Commands	Group
AA, Arc Absolute BZ, Bezier Absolute AR, Arc Relative AT, Absolute Arc Three Point CI, Circle RT, Relative Arc Three Point	<i>The Vector Group</i>
LA, Line Attributes LT, Line Type PW, Pen Width	<i>The Line and Fill Attributes Group</i>

BZ, Bezier Absolute

This command draws bezier curves using absolute coordinates. The BZ command uses the current pen position as the first control point, and specifies the other three control points as absolute coordinates.

BZ $X_1, Y_1, X_2, Y_2, X_3, Y_3, \dots [X_1, Y_1, X_2, Y_2, X_3, Y_3]$

Parameter	Format	Functional Range	Default
$X_1, Y_1 \dots$ (control points)	current units	-2^{23} to $2^{23} - 1$	no default

The BZ command uses the current pen location and three specified control points to draw a bezier curve. After each new Bezier, the last control point of the previous curve becomes the first control point of the next Bezier. All curve control points are specified as absolute coordinates.

Bezier curves are drawn with the current pen, line type, current line attributes, and pen-state (up/down). The curve is clipped to the hard-clip limits and the soft-clip window. Following the command execution, the current pen position is updated to the end point of the curve.

The BZ command is allowed in Polygon Mode. (The first chord after PM1 is not treated as a pen-up move.)

- **$X_1, Y_1 \dots$** — Specify the location of the second (X_1, Y_1), third (X_2, Y_2), and fourth (X_3, Y_3) control points, as absolute coordinates.

Table 20-14 Example: Using the BZ Command (Bezier Absolute)

$E_C E$	Reset the printer.
$E_C \% \emptyset B$	Enter HP-GL/2 mode.
IN;	Initialize HP-GL/2 mode.
SP1;	Select pen number 1. Even though there is no physical pen, the SP command must be used to enable printing.

Table 20-14 Example: Using the BZ Command (Bezier Absolute)

PA1016,5080;	Specify the absolute point (1016,5080) as the starting location.
PR;PD;	Specify relative plotting and pen down.
BZ1016,8128,5588,5080,	
4572,7112,4064,8128,	
7112,7620,7112,2032;	Draw a Bezier using the current position (1016,5080) as the first control point. The specified control points for the first curve are (1016,8128), (5588,5080), and (4572,7112). The second curve uses the last control point of the previous curve as the first control point (4572,7112). The other three control points for the second curve are (4064,8128), (7112,7620), and (7112,2032).
$E_C\%ØA$	Enter the PCL mode.
$E_C E$	Send a reset to end the job and eject the page.

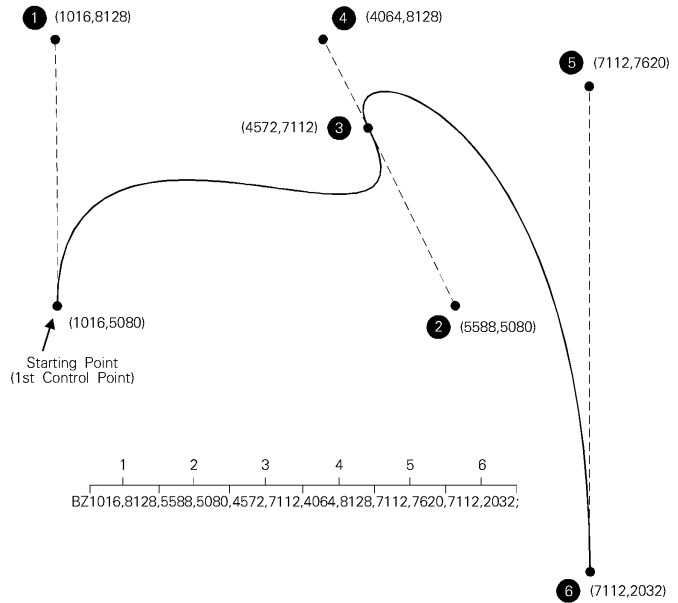

Figure 20-14

Table 20-15

Related Commands	Group
AA, Arc Absolute BR, Bezier Relative AR, Arc Relative AT, Absolute Arc Three Point CI, Circle RT, Relative Arc Three Point	<i>The Vector Group</i>
LA, Line Attributes LT, Line Type PW, Pen Width	<i>The Line and Fill Attributes Group</i>

CI, Circle

This command draws the circumference of a circle using the specified radius and chord angle. If you want a filled circle, refer to the WG or PM commands.

CI *radius[,chord angle;]*

Parameter	Format	Functional Range	Default
radius	current units	-2^{30} to $2^{30} - 1$	no default
chord angle	clamped real	0.5° to 180°	5°

The CI command includes an automatic pen down. When a CI command is received, the pen lifts, moves from the center of the circle (the current pen location) to the starting point on the circumference, lowers the pen, draws the circle, then returns with the pen up to the center of the circle. After the circle is drawn, the previous pen up/down status is restored. To avoid leaving a dot at the center of the circle, move to and from the circle's center with the pen up.

- **Radius** — Measured from the current pen location. Coordinates are interpreted in current units: as user-units when scaling is on; as plotter units when scaling is off.
- **Chord Angle** — Specifies the chord angle used to draw the arc. The default is a chord angle of 5°. Refer to the Arc Absolute (AA) command discussion, earlier in this chapter, for an explanation of the chord angle.

Each chord of the circle is drawn using the currently defined line type, width, and attributes. (Refer to Chapter 22, *The Line and Fill Attributes Group*, for more information.) Do not use an adaptive (negative) line type to draw a circle, as the printer attempts to draw a complete pattern for every chord (72 with the default chord angle). Always use isotropic scaling in drawings that contain circles, unless you want your circles to "stretch" with aspect ratio changes of the drawing (anisotropic scaling may produce an ellipse). For more information, refer to Chapter 19 for a scaling discussion and for the Scale (SC) command description.

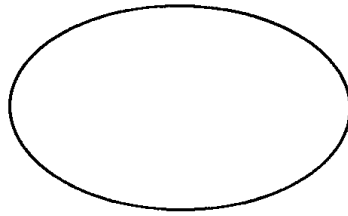

Anisotropic
scaling

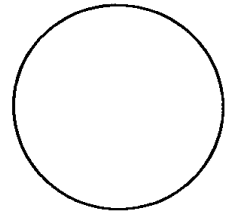

Isotropic
scaling

Figure 20-15

Table 20-16 Example: Effects of Chord Angle on Circle Smoothness

$E_C E$	Reset the printer.
$E_C \% \text{Ø} B$	Enter HP-GL/2 mode.
IN;	Initialize HP-GL/2 mode.
SP1;	Select pen number 1 (black).
SC-3000,3000, -2000,2000,1;	Specify scaling mode, making P1 equal to (-3000,-2000) user-units and P2 equal to (3000,2000) user-units. Isotropic scaling is specified.
PA-1700,2000; CI750,45;	Specify absolute plotting and move to (-1700,2000), the center of the circle to be drawn. Draw a circle with a radius of 750 user-units and a chord angle of 45°.
PA300,2000; CI750,30;	Specify absolute plotting and move to (300,2000) to draw another circle. Draw this circle with a radius of 750 user-units and a chord angle of 30°.

Table 20-16 Example: Effects of Chord Angle on Circle Smoothness (continued)

PA-1700,-200; CI750,15;	Specify absolute plotting and move to (-1700,-200), the center point of a third circle. Draw this circle with a radius of 750 user-units and a chord angle of 15°.
PA300,-200; CI750;	Specify absolute plotting and move to (300,-200), the center of the fourth circle. Draw this circle with a radius of 750 user-units and a chord angle of 5° (default).
E _C %ØA	Enter the PCL mode.
E _C E	Send a reset to end the job and eject the page.

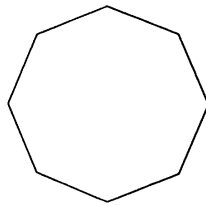

45-Degree chord angle

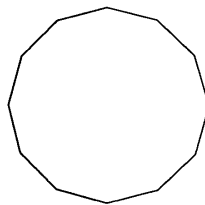

30-Degree chord angle

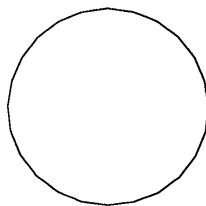

15-Degree chord angle

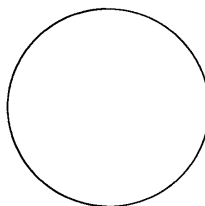

5-Degree chord angle

Figure 20-16

Table 20-17 Example: Drawing Circles with Different Radii and Line Types

$E_C E$	Reset the printer.
$E_C \% \emptyset B$	Enter HP-GL/2 mode.
IN;	Initialize HP-GL/2 mode.
SP1;	Select pen number 1 (black).
SC-75,75,-75,75,1;	Set up user scaling with (-75,-75) as P1 and (75,75) as P2; the "1" parameter specifies isotropic scaling.
PA0,0;	Specify absolute plotting and move to user-unit location (0,0).
LT;CI5;	Specify a default line type (solid) and draw a circle with a radius of 5 user-units.
LT0;CI-12;	Select line type 0 (dotted) and draw a circle with a radius of 12 user-units (the minus sign indicates starting at the 180° point).
LT1;CI19;LT2; CI-26;	Select line type 1 and draw a circle with a radius of 19 user-units. Then select line type 2 and draw a circle with a radius of 26 user-units.
LT3;CI33;LT4; CI-40;	Select line type 3, draw a circle with a radius of 33 user-units. Then select line type 4 and draw a circle with radius of 40 user-units.
LT5;CI47;LT6;CI54;	Draw the outer two circles; the first with a line type of 5 and a radius of 47 user-units; the second with a line type of 6 and a radius of 54 user-units.
$E_C \% \emptyset A$	Enter the PCL mode.
$E_C E$	Send a reset to end the job and eject the page.

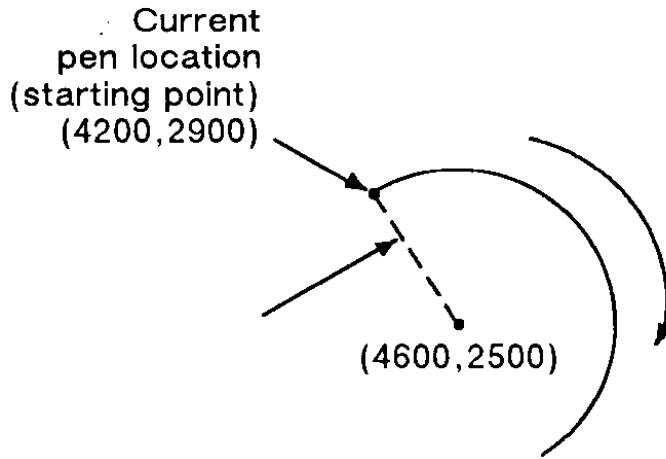

Figure 20-17

Table 20-18

Related Commands	Group
EW, Edge Wedge WG, Fill Wedge	<i>The Polygon Group</i>
SC, Scale	<i>The Configuration/Status Group</i>
AA, Arc Absolute AR, Arc Relative AT, Absolute Arc Three Point RT, Relative Arc Three Point	<i>The Vector Group</i>
LA, Line Attributes LT, Line Type PW, Pen Width	<i>The Line and Fill Attributes Group</i>

PA, Plot Absolute

This command establishes absolute plotting and moves the pen to the specified absolute coordinates from the current pen position.

PA *X,Y [,...;]*

or

PA *[;]*

Parameter	Format	Functional Range	Default
X,Y coordinates	current units	-2^{30} to $2^{30} - 1$	no default

The printer interprets the parameters as follows:

- **No Parameters** — Establishes absolute plotting for subsequent commands.
- **X,Y Coordinates** — Specify the absolute location to which the pen moves. When you include more than one coordinate pair, the pen moves to each point in the order given, using the current pen up/down status. If the pen is up, PA moves the pen to the point; if the pen is down, PA draws a line to the point. Lines are drawn using the current line width, type, and attributes.
- When you use the symbol mode (SM) command, PA draws the specified symbol at each X,Y coordinate. When you use the polygon mode (PM) command, the X,Y coordinates enter the polygon buffer for use when the polygon is edged or filled.
- Coordinates are interpreted in current units: as user-units when scaling is on; as plotter units when scaling is off.

Note

If an odd number of coordinates is specified (in other words, an X coordinate without a corresponding Y coordinate), the printer ignores the last unmatched coordinate.

Table 20-19

Related Commands	Group
PE, Polyline Encoded PR, Plot Relative PD, Pen Down PU, Pen Up	<i>The Vector Group</i>
LA, Line Attributes LT, Line Type PW, Pen Width SM, Symbol Mode	<i>Line and Fill Attributes Group</i>

PD, Pen Down

This command lowers the printer's "logical pen" and draws subsequent graphics commands.

PD X,Y[,...:]

or

PD [:]

Parameter	Format	Functional Range	Default
X,Y coordinates/ increments	current units	-2^{30} to $2^{30} - 1$	no default

This command emulates a pen plotter which must lower the pen to draw lines on the page.

- **No Parameters** — Prepares the printer to draw subsequent graphics commands.
- **X,Y Coordinates/Increments** — Draws (in current units) to the point specified. You can specify as many X,Y coordinate pairs as you want. When you include more than one coordinate pair, the printer draws to each point in the order given.

- Coordinates are interpreted in current units: as user-units when scaling is on; as plotter units when scaling is off.
- Whether the PD command uses coordinates or increments depends on the most recently executed PA or PR command. If no PA or PR command is issued, absolute plotting (PA) is used.
- When you use the symbol mode (SM) command, PD draws the specified symbol at each X,Y coordinate. When you use the polygon mode (PM) command, the X,Y coordinates enter the polygon buffer (and are used when the polygon is edged or filled).

Table 20-20 Example: Using the Pen Down Command

$E_C E$	Reset the printer.
$E_C \% \emptyset B$	Enter HP-GL/2 mode.
IN;	Initialize HP-GL/2 mode.
SP1;	Select pen number 1. Even though there is no physical pen, the SP command must be used to enable printing.
PA10,10;	Begin absolute plotting from coordinate (10,10).
PD2500,10,10,1500,10,10;	Set the Pen Down and draw lines between the specified points.
$E_C \% \emptyset A$	Enter the PCL mode.
$E_C E$	Send a reset to end the job and eject the page.

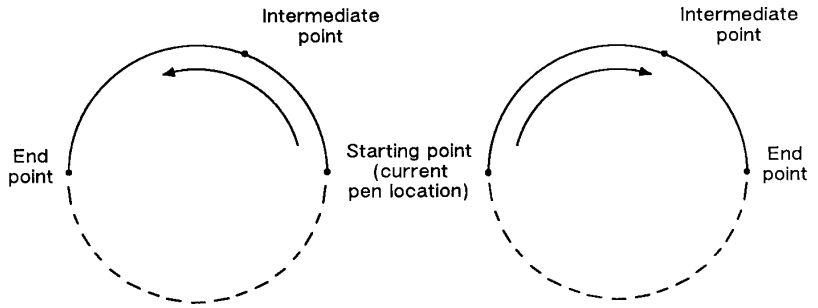

Figure 20-18

Note

If an odd number of coordinates is specified (an X coordinate without a corresponding Y coordinate), the printer ignores the last unmatched coordinate

Table 20-21

Related Commands	Group
PA, Plot Absolute PE, Polyline Encoded PR, Plot Relative PU, Pen Up	<i>The Vector Group</i>
LA, Line Attributes LT, Line Type PW, Pen Width SM, Symbol Mode	<i>Line and Fill Attributes Group</i>

PE, Polyline Encoded

This command incorporates the PA, PR, PU, PD, and SP commands into an encrypted format that substantially decreases the size of your file and the time required for data transmission. (This command is especially useful when using an RS-232-C interface.)

```
PE [flag[value]][coord_pair...[flag[value]][coord_pair];
```

or

```
PE;
```

Note

Parameter values are self-terminating; do not use commas with this command. Also, you *must* use a semicolon to terminate PE.

Parameter	Format	Functional Range	Default
flag	character	':', '<', '>', '=', or '7'	no default
value	character	flag dependent*	
coordinate pair	character	-2^{30} to $2^{30} - 1$	no default
* Refer to the table following the parameter description.			

Lines are drawn using the current line type and current units. The printer draws to all points with the pen down unless a pen up flag precedes the X,Y coordinates. If the final move is made with the pen up, the pen remains in the up position; otherwise the pen is left in the down position.

The PE command causes the printer to interpret coordinate pairs as relative coordinates unless they are preceded by an absolute value flag (=). Relative integer coordinates produce the most compact data stream. For best results, scale your drawings so you use only integer coordinates and use relative plotting mode. After PE is executed, the previous plotting mode (absolute or relative) is restored.

The PE command represents vectors in base 64 (default) or base 32 (explained under *Encoding PE Flag Values and X,Y Coordinates*). In parameter value data, all spaces, delete characters, control characters, as well as ASCII characters 128-160 and 255 are ignored.

- **No parameters** — Updates the Carriage Return point. The PE command without parameters does not affect the pen's current location or up/down status.
- **Flag** — Indicates how the printer interprets subsequent values. Flags are ASCII characters and are not encoded. The printer disregards the eighth bit of a flag (for example, a character code of 61 and a character code of 189 both send a '=' [the absolute flag]).

Table 20-22

Flag	Meaning	Description
:	Select Pen	Indicates that the subsequent value is the desired pen number. A PE command without pen select defaults to the currently selected pen.
<	Pen Up	Raises the pen and moves to the subsequent coordinate pair value. (All coordinate pair values not preceded by a pen up flag are considered pen down moves.)*
>	Fractional Data	Indicates that the subsequent value specifies the number of fractional binary bits contained in the coordinate data. Default is zero.
=	Absolute	Indicates that the next point is defined by absolute coordinates.
7	7-bit Mode	Indicates that all subsequent coordinate pair values should be interpreted in 7-bit mode. Once you send a seven-bit flag, base 32 is used and eighth bits are ignored for the remainder of the command.

* We recommend you always follow a pen up flag with a relative move of (0,0). This ensures that the next plotting coordinates are drawn.

Note

Because SP is not allowed in polygon mode, if you select a pen within PE while in polygon mode, the Select Pen command is ignored.

- **Value** — Specifies data according to the preceding flag. For example, a value following a select-pen flag should be a pen number. Flag values are encoded in the same manner as coordinate data. Instructions for encoding flag values follow the parameter descriptions.
- *Pen Number* — Specifies the pen to be selected (black [1] or white [0]). The pen number must be encoded into a base 64 or base 32 equivalent.
- *Number of Fractional Binary Bits* — Specifies the number of fractional binary bits contained in the coordinate data. The number of fractional binary bits must be encoded into a base 64 or base 32 equivalent (see the explanation on the next page).

Table 20-23

Value	Format	Range¹
pen number	integer	0 to 1
number of fractional binary bits	integer	-26 to 26

1. PR and PE have extended ranges of -2^{30} to $2^{30} - 1$ plotter units. If the current pen position goes out of this range, the printer ignores plotting commands until it receives an absolute PA or PE coordinate within the extended ranges.

- **X,Y Coordinates** — Specifies a coordinate pair encoded into a base 64 (default) or a base 32 equivalent. Use base 64 if your system can send 8 bits of data without parity. Use 7-bit mode and base 32 coordinate values if your system requires a parity bit.
- When you are in symbol mode (refer to the SM command in Chapter 22, *The Line and Fill Attributes Group*), PE draws the specified symbol at each X,Y coordinate. When you are in polygon mode (refer to the PM command in Chapter 21, *The Polygon Group*), the X,Y coordinates enter the polygon buffer; they are used when the polygon is edged or filled.

Encoding PE Flag Values and X,Y Coordinates

Flag values and X,Y coordinates are encoded into a base 64 (default) or base 32 equivalent (7-bit mode).

The following steps give a generic algorithm for encoding a number. Assume x is the number to be encoded. Use steps 1 and 2 only if you are encoding fractional data; otherwise, begin with step 3.

Note

When converting numbers to base 32 or 64 (step 4 in the following instructions), note that highest order digits are always in the high range, all other digits are in the low range. Therefore, if there is only one digit in a number, it is in the high range.

Table 20-24 Procedure to encode a number

STEPS	EXAMPLE
1. Fraction adjustment. If you are using fractional data, this step converts the number of decimal places in your data to the number of binary fractional bits. Assume "n" is the number of fractional binary bits specified by the fractional data flag.	$x = 82.83$
a. Multiply the number of decimal places contained in the data by 3.33.	$2 \times 3.33 = 6.66$
b. Round that number up to the next integer to get integer n.	
$n = \text{round}(\text{decimal places} \times 3.33)$	$n = 7$
$x = x \times 2^n$	$x = 82.83 \times 2^7 = 10,525.42$

Table 20-24 Procedure to encode a number (continued)

2. Round to an integer. Round the results of step 1 to the nearest integer.

$$x = \text{round}(x)$$

$$x = \text{round}(10,525.42) = 10,525$$

3. Set the sign bit. If x is positive, multiply it by two. If x is negative, multiply the absolute value of x by two and add one. This sets the sign bit.

if ($x \geq 0$)

$$x = 2 \times x$$

$$x = 2 \times 10,525 = 21,050$$

else

$$x = 2 \times \text{abs}(x) + 1$$

4. Convert the number to base 64 or 32 and encode the data. Convert x to a base 64 number if your system sends 8 bits without parity. Convert x to a base 32 number if your system sends 7 bits with parity (seven-bit flag is sent).

Encode each base 64 or 32 digit into the ASCII character range, as described below. Output each character as it is encoded, starting with the least significant digit. The most significant digit is used to terminate the number and is encoded into a different ASCII character range than the low order digits.

Each number in a coordinate pair is represented as zero or more non-terminator characters, followed by a terminator character. A character is a non-terminator or terminator depending on the range it is in; refer to the following table. For example, in base 64 there are 64 non-terminator and 64 terminator characters. Either kind represents a "digit."

Table 20-25 Terminator and non-terminator characters

Range Type	Non-terminator	Terminator
8-bit Range (base 64)	63-126	191-254
7-bit Range (base 32)	63-94	95-126

Note

Values following the fractional data or select pen flag also must be encoded.

```

while n &geq; base
output CHR$(63 + (n MOD base))
n = n DIV base
end
if base = 64 then n = 191 + n
if base = 32 then n = 95 + n
output CHR$(n)

```

Table 20-26 Procedure for determining base range

STEPS

EXAMPLE

Base 64. Encode all the low order digits into the ASCII range 63 to 126. For a digit with value i, use ASCII character "+CHR\$(F) " CHR\$(63 + i).| Encode the highest order digit (or the single digit in a one-digit number) into the range 191 to 254.

21,050 ÷ 4096 = 5
 remainder 570
 570 ÷ 64 = 8 remainder
 58
 5 - 4096ths place
 58 - 1's place

Low order digit: 1's place
 (63-126)
 63 + 58 = 121
 CHR\$ (121)

Table 20-26 Procedure for determining base range (continued)

Next order digit: 64ths place
(63-126)

$$63 + 8 = 71$$

CHR\$(71)

High order digit: 4096ths
place (191-254)

$$191 + 5 = 196$$

CHR\$(196)

Base 32. Encode all the low order digits into the ASCII range 63 to 94. For a digit with value i , use ASCII character CHR\$(63 + i). Encode the highest order digit (or the single digit in a one-digit number) into the range 95 to 126.

$21,050 \div 1024 = 20$
remainder 570

$570 \div 32 = 17$
remainder 26

20 - 1024ths place

17 - 32nds place

26 - 1's place

Low order digit: 1's (range
63-94)

$$63 + 26 = 89$$

CHR\$(89)

Next order digit: 32's place
(63-94)

$$63 + 17 = 80$$

CHR\$(80)

High order digit: 1024ths
place (95-126)

$$95 + 20 = 115$$

CHR\$(115)

When using PE (in the default relative mode), the application program does not know the current pen location after printing a label (normally, the current pen location is updated to the end of the label.) If this presents a problem in your program, follow these steps.

- 1 Create a flag called "lost" in your program.
- 2 After labeling (or any command which updates the current pen location), set lost to true.
- 3 If lost = true at the beginning of the PE command, use an absolute flag for the first coordinate pair only (subsequent coordinates are interpreted as relative).
- 4 Set lost to false.

Note

At the beginning of your application program, set lost to true. Then, specify the next coordinate in absolute mode (PA or PE=).

When converting and encoding data, note the following.

- $n \text{ DIV } 64 = n.\text{shift right}.6 \text{ bits}$. You can optimize your application by shifting 6 bits to the right since shifting is faster than division.
- $n \text{ MOD } 64 = n.\text{AND}.63$. The number is logically AND'd with 63.

Example: Using the PE Command

The following BASIC program converts three relative real coordinates to base 64.

```
``10 LPRINT CHR$(27);"E"; 'Reset the Printer.``  
``20 LPRINT CHR$(27);"%0B"; 'Enter HP-GL/2 Mode.``  
``30 LPRINT "IN;SC1,20,1,20,1;SP1;PU5,5;";``  
``40 PRINT "Input number of fractional decimal places in data" ``  
``50 INPUT F 'In this example, 2 decimal places (line 290).``  
``60 'Calculate Number of Fractional Binary Bits ``  
``70 F = F * 3.33 ``  
``80 F = INT(F) ``  
``90 A = F ``  
``100 IF F >= 0 THEN F = 2*ABS(F) ELSE F = 2*ABS(F)+1 ``  
``110 F = 191+F ``  
``120 LPRINT #1, "PE>"+CHR$(F) ``
```

```

''130 'Convert coordinate data to base 64 ''
''140 FOR J = 1 to 6 ''
''150 READ C ''
''160 C = C * (2^A) ''
''170 C = INT(C) ''
''180 IF C = 0 THEN C = 2*C ELSE C = 2*ABS(C)+1 ''
''190 WHILE C = 64 ''
''200 LPRINT CHR$(63+(C MOD 64)) ''
''210 C = C64 ''
''220 WEND ''
''230 C = 191+C ''
''240 LPRINT CHR$(C) ''
''250 NEXT J ''
''260 LPRINT ";"; ''
''270 LPRINT CHR$(27);"%0A"; 'Enter PCL Mode ''
''280 LPRINT CHR$(27);"E"; 'Reset to eject page.''
''290 DATA 10.58,0,-5.58,10.67,-5,-10.67 ''
''300 END ''

```

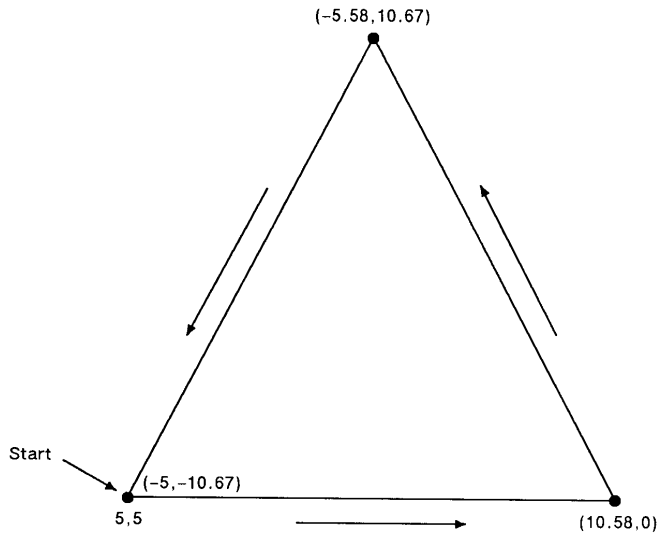

Figure 20-19

Table 20-27

Related Commands	Group
PA, Plot Absolute PD, Pen Down PR, Plot Relative PU, Pen Up	<i>The Vector Group</i>
LA, Line Attributes LT, Line Type PW, Pen Width SM, Symbol Mode	<i>Line and Fill Attributes Group</i>

PR, Plot Relative

This command establishes relative plotting and moves the pen to specified points, with each move relative to the current pen location.

PR *X,Y[,...;]*

or

PR *[;]*

Parameter	Format	Functional Range	Default
X,Y (increments)	current units	-2^{30} to $2^{30} - 1$	no default

* PR and PE have extended ranges of -2^{30} to $2^{30} - 1$ plotter units. If the current pen position goes out of this range, the printer ignores HP-GL/2 commands until it receives an absolute PA or PE coordinate within the extended range.

The printer interprets the parameters as follows:

- **No Parameters** — Defaults to relative plotting mode for subsequent commands.
- **X, Y (Increments)** — Specify incremental moves relative to the current pen location. When you include more than one relative coordinate pair, the pen moves to each point in the order given (relative to the previous point), using the current pen up/down status. If the pen is up, PR moves the pen to the point; if the pen is down, PR draws a line to the point. Lines are drawn using the current line width, type, and attributes.
 - When you use the symbol mode (SM) command, PR draws the specified symbol at each X,Y coordinate. When you use the polygon mode (PM) command, the X,Y coordinates enter the polygon buffer (and are used when the polygon is edged or filled).
 - Coordinates are interpreted in current units: as user-units when scaling is on; as plotter units when scaling is off.

Table 20-28 Example: Using the PR Command

$E_C E$	Reset the printer.
$E_C \% \emptyset B$	Enter HP-GL/2 mode.
IN;	Initialize HP-GL/2 mode.
SP1;	Select pen number 1. The SP command must be used to enable printing.
PA10,10;PD;	Move to absolute position (10,10) and put the pen down.
PR2500,0,-2500, 1500,0,-1500;	Specify relative plotting and draw lines beginning at (10,10) and then moving the relative coordinate distances indicated.
$E_C \% \emptyset A$	Enter the PCL mode.
$E_C E$	Send a reset to end the job and eject the page.

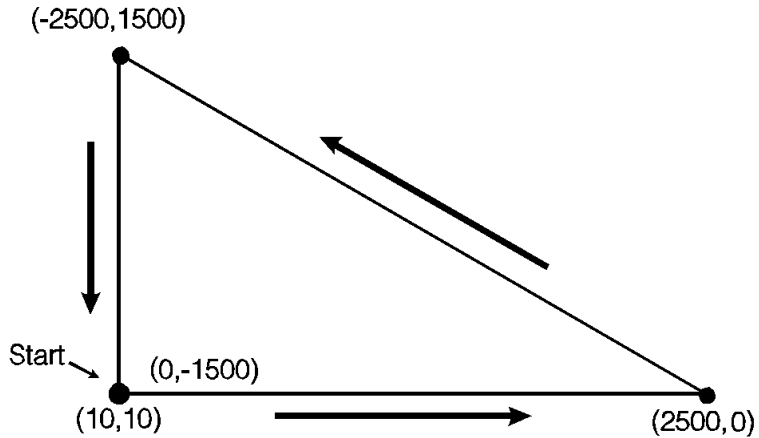

Figure 20-20

Note

If an odd number of coordinates is specified (an X coordinate without a corresponding Y coordinate), the printer ignores the last unmatched coordinate.

Table 20-29

Related Commands	Group
PA, Plot Absolute PD, Pen Down PE, Polyline Encoded	<i>The Vector Group</i>
LA, Line Attributes LT, Line Type PW, Pen Width SM, Symbol Mode	<i>Line and Fill Attributes Group</i>

U, Pen Up

This command moves to subsequent points without drawing. Use PU to move to another location without drawing a connecting line.

PU *X,Y[,...;]*

or

PU *[;]*

Parameter	Format	Functional Range	Default
X,Y coordinates/ increments	current units	-2^{30} to $2^{30} - 1$	no default

The PU command emulates a pen plotter which must raise the pen to prevent drawing stray lines on the page.

- **No Parameters** — Prevents drawing subsequent graphics commands (unless the command contains an automatic pen down).
- **X, Y Coordinates/Increments** — Move to the point(s) specified. You can specify as many X,Y coordinate pairs as you want. When you include more than one coordinate pair, the printer moves to each point in the order given.

- When you use the Symbol Mode (SM) command, PU draws the specified symbol at each X,Y coordinate. When you use the polygon mode (PM) command, the X,Y coordinates enter the polygon buffer (for use when the polygon is edged or filled).
- Coordinates are interpreted in current units: as user-units when scaling is on; as plotter units when scaling is off.
- Whether the PU command uses absolute coordinates or relative coordinates (increments) depends on the most recently executed PA or PR command. If you have not issued a PA or PR command, absolute plotting (PA) is used.

Note

If an odd number of coordinates is specified (in other words, an X coordinate without a corresponding Y coordinate), the printer ignores the last unmatched coordinate.

Table 20-30

Related Commands	Group
PA, Plot Absolute PD, Pen Down PE, Polyline Encoded PR, Plot Relative	<i>The Vector Group</i>
SM, Symbol Mode	<i>Line and Fill Attributes Group</i>

RT, Relative Arc Three Point

This command draws an arc segment, using relative coordinates, from a starting point through an intermediate point to an end point. Use RT when you know these three points of an arc.

RT $X_{incr\ inter}, Y_{incr\ inter}, X_{incr\ end}, Y_{incr\ end}[,\textit{chord\ angle};]$

Parameter	Format	Functional Range	Default
$X_{incr\ inter}, Y_{incr\ inter}$	current units	-2^{30} to $2^{30} - 1$	no default
$X_{incr\ end}, Y_{incr\ end}$	current units	-2^{30} to $2^{30} - 1$	no default
chord angle	clamped real	0.5° to 180°	5°

The RT command uses the current pen location and two specified points to calculate a circle and draw the appropriate arc segment of its circumference. The arc starts at the current pen location, using the current pen, line type, line attributes and pen up/down status. You specify the intermediate and end points. After drawing the arc, the pen location remains at the end of the arc.

- **$X_{Incr\ Inter}, Y_{Incr\ Inter}$** — Specify the location of an intermediate point of the arc in relative increments (relative to the current pen location). The arc is drawn in a negative or positive direction, as necessary, so that it passes through the intermediate point before the end point.
- **$X_{Incr\ End}, Y_{Incr\ End}$** — Specify the location of the end point of the arc in relative increments (relative to the current pen location).
- **Chord Angle** — Specifies the chord angle used to draw the arc. The default is a chord angle of 5° . (The Arc Absolute command description, earlier in this chapter, contains more information on chords and chord angles.)

Intermediate and end point coordinates are interpreted in current units: as user-units when scaling is on; as plotter units when scaling is off. If current scaling is not isotropic, the arc drawn is elliptical rather than circular. Note the following about intermediate and end points:

- If the intermediate point and end point are the same as the current pen location, the command draws a dot.
- If the intermediate point is the same as either the current pen location or the end point, a line is drawn between the current pen location and the end point.

- If the end point is the same as the current pen location, a circle is drawn, with its diameter being the distance between the current pen position and the intermediate point.
- If the current pen position, intermediate point, and end point are collinear, a straight line is drawn.
- If the intermediate point does not lie between the current pen location and the end point, and the three points are collinear, two lines are drawn, one from the current pen location and the other from the end point, leaving a gap between them. Refer to the following illustration. Both lines extend to the PCL Picture Frame limits or current window.

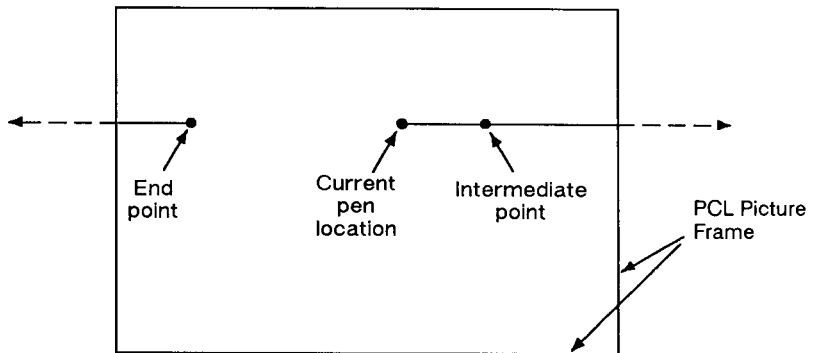

Figure 20-21

Table 20-31 Example: Using the RT Command (Relative Arc Three Point)

$E_C E$	Reset the printer.
$E_C \% \text{Ø} B$	Enter HP-GL/2 mode.
IN;	Initialize HP-GL/2 mode.

Table 20-31 Example: Using the RT Command (Relative Arc Three Point) (continued)

SP1;	Select pen number 1. Even though there is no physical pen, the SP command must be used to enable printing.
PA1000,100;	Specify the absolute point (1000,100) as the starting location.
PR;PD1500,0;	Specify relative plotting, pen down, and draw (1500,0) relative plotter units from the current pen location (1000,100).
PU-1850,1050; PD350,0;	Lift the pen, move (-1850,1050) relative coordinates, place the pen down, and draw a line 350 plu in the X direction.
PU-350,-700; PD350,0;	Lift the pen, move (-350,-700) plu from the current location, place the pen down, and draw a line 350 plu in the X direction.
PU0,-350;PD0,1500,1500,0;	Lift the pen, move 350 plu to the left, place the pen down, draw a line 1500 plu up and then another line 1500 units to the right.
RT700,-750,0,-1500;	Draw an arc from the current pen position through a point (700,-750) plu away, with an ending point (0,-1500) plu from the beginning of the arc.
PU700,850;PD;	Lift the pen and move it (700,850) plu from the current pen position; pen down.

Table 20-31 Example: Using the RT Command (Relative Arc Three Point) (continued)

RT100,-100,0,-200;	Draw an arc from the current pen position, through a point (100,-100) plu away, with an ending point (0,-200) from the starting point of the arc.
PU100,100;PD200,0;	Lift the pen and move it (100,100) plu from the current pen position, pen down, and draw a line 200 plu in the X direction.
$E_C\%ØA$	Enter the PCL mode.
$E_C E$	Send a reset to end the job and eject the page.

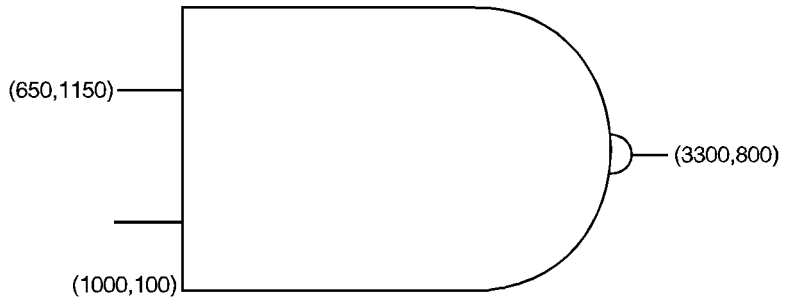

Figure 20-22

Table 20-32

Related Commands	Group
AA, Arc Absolute AR, Arc Relative AT, Absolute Arc Three Point BR, Bezier Relative BZ, Bezier Absolute CI, Circle	<i>The Vector Group</i>
LA, Line Attributes LT, Line Type PW, Pen Width	<i>The Line and Fill Attributes Group</i>

21

The Polygon Group

Introduction

All of the commands in this group use the *polygon buffer*, a temporary data storage area in your printer. Using the polygon buffer is an integral part of drawing wedges, rectangles, and other types of polygons. Some of the commands in this chapter define and draw complete shapes while others act only on the contents of the polygon buffer. The information in this chapter enables you to achieve the following results in your programs:

- Draw circles, wedges, and rectangles.
- Use polygon mode for drawing polygons, subpolygons, and circles.

The following commands are described in this chapter:

Table 21-1 The Polygon Group Commands

Command	Summary
EA, Edge Rectangle Absolute	Outlines a rectangle defined with absolute coordinates.
EP, Edge Polygon	Outlines the contents of the polygon buffer.
ER, Edge Rectangle Relative	Outlines a rectangle defined with relative coordinates.
EW, Edge Wedge	Defines and outlines a wedge-shaped polygon.
FP, Fill Polygon	Fills the polygon shape specified in the polygon buffer.
PM, Polygon Mode	Allows you to create user-defined polygons in the polygon buffer.

Table 21-1 The Polygon Group Commands (continued)

RA, Fill Rectangle Absolute	Fills a rectangle specified with absolute coordinates.
RR, Fill Rectangle Relative	Fills a rectangle specified with relative coordinates.
WG, Fill Wedge	Defines and fills a wedge-shaped polygon.

Using the Polygon Buffer

As mentioned, a buffer is a temporary storage area for information. The *polygon buffer* collects the commands and coordinates that define a polygon you want to print. This polygon remains in the buffer until replaced by another polygon, or until the buffer is cleared by initializing the printer. Some commands use the polygon buffer automatically, while other commands require that you enter the polygon mode. The following commands use the polygon buffer, but do not allow you to enter polygon mode first.

Table 21-2

Mnemonic	Command Name
EA,	Edge Rectangle Absolute
ER,	Edge Rectangle Relative
EW,	Edge Wedge
RA,	Fill Rectangle Absolute
RR,	Fill Rectangle Relative
WG,	Fill Wedge

Drawing Rectangles

You can draw a rectangle by outlining (edging) the defined area using the Edge Rectangle Absolute (EA) or Edge Rectangle Relative (ER) commands.

To draw a rectangle, the printer uses the current pen location for one corner; you give the coordinates for the diagonally opposite corner. The printer draws the rectangle defined by these two points. The following simple command sequence uses EA to draw a rectangle.

Table 21-3

Example: Drawing Rectangles	
?E	Reset the printer.
?%0B	Enter HP-GL/2 mode.
IN;	Initialize HP-GL/2 mode.
SP1;	Select pen number 1 (black). You must select a pen to print HP-GL/2 images.
PA10,10;	Specify absolute plotting and move to (10,10).
EA2500,1500;	Draw the outline of a rectangle, with the lower left corner being the current pen location (10,10) and the upper right corner being (2500,1500).
?%0A	Enter the PCL mode.
?E	Send a reset to end the job and eject the page.

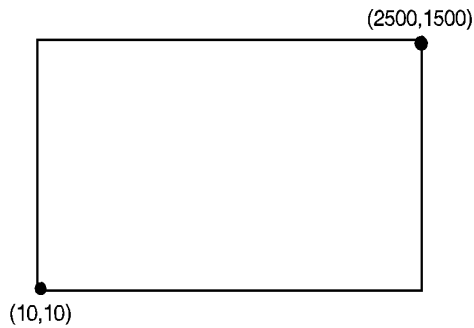

Figure 21-1

The Fill Rectangle Absolute (RA) and Fill Rectangle Relative (RR) commands, both discussed later in this chapter, fill their rectangles with the default or current fill pattern. You may also want to edge (or outline) the rectangle for better image definition with some fill types. The following command sequence draws two filled rectangles: one edged and one not.

Table 21-4 Example: Filled Rectangles

?E	Reset the printer.
?%0B	Enter HP-GL/2 mode.
IN;	Initialize HP-GL/2 mode.
SP1;	Select pen number 1. Even though there is no physical pen, the SP command must be used to enable printing.
PA0,0;	Specify absolute plotting and move to location (0,0).
FT3;	Specify fill type 3 (hatching—parallel lines).
RR1500,1000;	Fill a rectangular shape with the currently active fill pattern. The lower left corner of the rectangle should be the current location (0,0), and the upper right corner should be 1500 plu in the X direction and 1000 plu in the Y direction from the starting location.

Table 21-4 Example: Filled Rectangles (continued)

EP;	Draw an edge around the rectangle that was just drawn. Since the previous RR command leaves its definition in the polygon buffer (1500,1000), you do not need to specify the coordinates again.
PR2000,0;	Specify relative plotting and move the cursor 2000 plu in the X direction from the current pen location.
FT4,100,45;	Specify fill type number 4 (cross-hatching), set the spacing to 100 plu between fill lines, and set the fill line angle to 45°.
RR1500,1000;	Fill a rectangle with the currently specified fill type. Use the current pen location (0,0) as the lower left corner of the rectangle and a point (1500,1000) relative plu away for the upper right corner.
?%0A	Enter the PCL mode.
?E	Send a reset to end the job and eject the page.

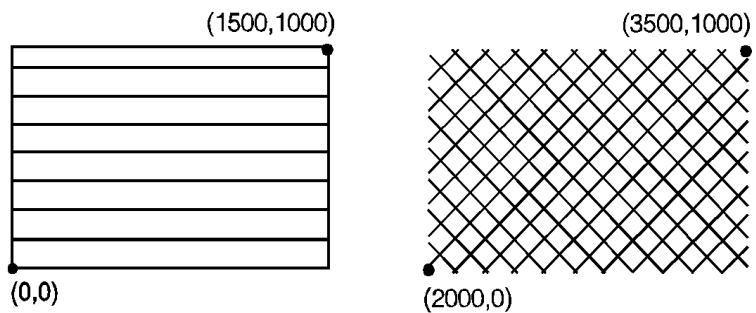

Figure 21-2

Drawing Wedges

A wedge is a section of a circle. Wedges are commonly used to draw pie charts. You can draw a wedge by outlining (edging) the defined area using the Edge Wedge (EW) command, or you can create filled wedges using the Fill Wedge (WG) command.

The wedge commands use your current pen location as the center point; you specify the radius, the start angle, and the sweep angle. The *radius* determines the length of the two sides of the wedge. The sign (positive or negative) of the radius determines the location of a 'zero-degree' reference point. The *start angle* is the number of degrees from the zero reference point at which you want to draw the first radius. The *sweep angle* is the number of degrees through which you want to draw the arc. To draw or fill a circle, simply specify a 360-degree sweep angle. Figure 21-4 shows the different parameters of a wedge with a positive radius.

Note

A *positive angle* of rotation is in the direction of the +X-axis to the +Y-axis as shown below. A *negative angle* of rotation is in the direction of the +X-axis to the -Y-axis.

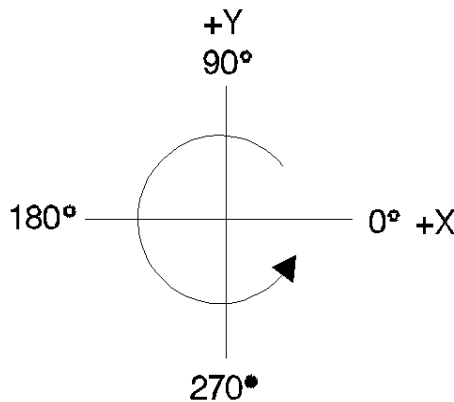

Figure 21-3

Note

The relationship of the +X-axis to +Y-axis (and -Y-axis) can change as a result of the scaling point or scaling factor changes, thus, changing the direction of a positive (or negative) angle of rotation.

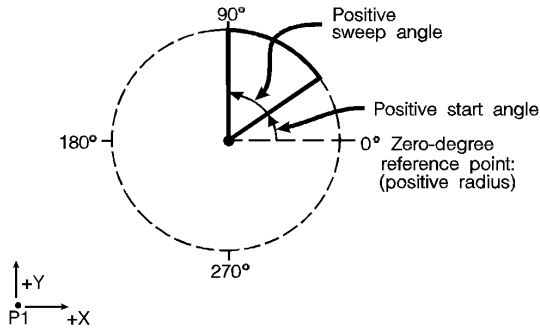

Figure 21-4 Drawing Wedges

The following example draws a wedge using the EW command. The radius of the wedge is 600 plotter units, the wedge begins 90° from the zero-degree reference point, and the wedge “sweeps” for 60°.

Note

In the example plots, some reference points are added which are not part of the example plot. These reference points are added for clarification.

Table 21-5 Example: Drawing Wedges

?E	Reset the printer.
?%0B	Enter HP-GL/2 mode.
IN;	Initialize HP-GL/2 mode.
SP1;	Select pen number 1. Even though there is no physical pen, the SP command must be used to enable printing.
PA2500,3500;	Specify absolute plotting and move to location (2500,3500).

Table 21-5 Example: Drawing Wedges (continued)

EW600,90,60;	Draw the outline of a wedge, using the current pen location (2500,3500) as the point of the wedge. The wedge has a radius of 600 plotter units, begins at 90° from the default zero-degree reference point, and “sweeps” for 60°.
?%0A	Enter the PCL mode.
?E	Send a reset to end the job and eject the page.

· P2

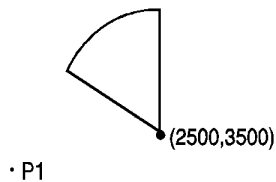

Figure 21-5

The following example uses different fill types with wedges and circles.

Table 21-6 Example: Filling Wedges and Circles

?E	Reset the printer.
?%0B	Enter HP-GL/2 mode.
IN;	Initialize HP-GL/2 mode.
SP1;	Select pen number 1 (black).
PA1400,2500;	Select absolute plotting mode and move to (1400,2500).
WG600,150,120;	Fill a wedge with radius 600 plu, a start angle of 150°, and a sweep angle of 120°. Since no fill type was specified, the wedge is black (solid black is the default fill type).

Table 21-6 Example: Filling Wedges and Circles (continued)

PA2300,2500;FT3, 75,45;	Specify absolute plotting and move to (2300,2500). Select fill type number 3 (hatching--parallel lines), with 75 plu between hatching lines, and hatching lines tilted at 45°.
WG600,90,180;	Fill a wedge with the current fill type; use a radius of 600 plu, a start angle of 90°, and a sweep angle of 180°.
FT1,0,0;WG600, 270,60;	Specify a fill type of solid black and fill a wedge using the same center and radius as the previous wedge. Start the wedge at 270° with a sweep of 60°.
FT4,60,45;WG600, 330,120;	Specify fill type number 4 (cross-hatching) with 60 plu between lines and the lines tilted at 45°. Fill a wedge using the same center and radius as the previous two wedges. Start the wedge at 330° with a sweep of 120°.
PA3500,2500; WG400,0,360;	Select absolute plotting and move to (3500,2500). Create a filled circle using the current fill type (cross-hatching), specifying a start angle of 0° and a 360° sweep.
PA4500,2500;FT; WG400,0,360;	Move to (4500,2500), select a solid fill, and fill a 360° wedge (circle).
?%0A	Enter the PCL mode.
?E	Send a reset to end the job and eject the page.

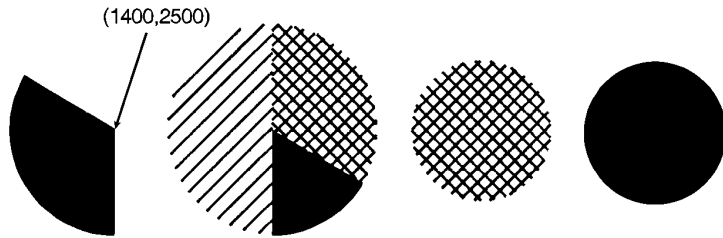

Figure 21-6

Drawing Polygons

A polygon consists of one or more closed sequences of connected line segments (which may cross each other). Drawing polygons requires the use of the polygon mode. The Polygon Mode (PM) command tells the printer to store subsequent commands and coordinates in the polygon buffer before printing the shape. (Rectangles and wedges are polygons which have their own drawing commands; the printer automatically generates and stores the coordinates in the polygon buffer.)

You can use the following commands in polygon mode to create polygons. These commands are stored in the polygon buffer until they are replaced with another polygon or the printer is initialized.

Table 21-7

Polygon Definition Commands	Group
AA, Arc Absolute	<i>The Vector Group</i>
AR, Arc Relative	
AT, Absolute Arc Three Point	
BR, Bezier Relative	
BZ, Bezier Absolute	
CI, Circle	
PA, Plot Absolute	
PD, Pen Down	
PE, Polyline Encoded	

Table 21-7 (continued)

PR, Plot Relative	
PU, Pen Up	
RT, Relative Arc Three Point	
PM1/PM2, Polygon Mode	<i>The Polygon Group</i>

Drawing Subpolygons

While in polygon mode, you can define either one polygon or a series of subpolygons. Like a polygon, a subpolygon is a closed sequence of connected line segments. For example, the block letter C is one complete polygon. However, the block letter D is actually two subpolygons: the outline and the 'hole.'

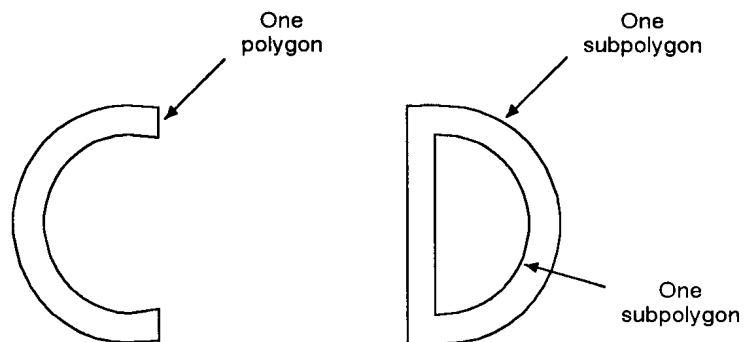

Figure 21-7 Drawing Subpolygons

To create one polygon, for example, the letter C, move the pen to the starting location for the polygon, then use the Polygon Mode (PM) command to enter polygon mode. Define the shape of the C using the appropriate commands and coordinates, then exit polygon mode. Now draw the polygon using either the Edge Polygon (EP) or Fill Polygon (FP) command.

To create a series of subpolygons, for example, the letter D, move the pen to the starting location of the first subpolygon, then enter polygon mode. Define the outer shape of the letter D using the appropriate commands and coordinates, then close the subpolygon, staying in polygon mode. Define the inner shape of the D, then exit polygon mode. Now draw the subpolygons using either the Edge Polygon (EP) or Fill Polygon (FP) command. For more information on entering and exiting polygon mode, refer to the Polygon Mode (PM) command discussed in this chapter.

In polygon mode, you can define points with the pen up or down. However, the Edge Polygon (EP) command only draws between points defined when the pen was down. In contrast, the Fill Polygon (FP) command fills between all points, regardless of whether they were defined when the pen was up or down. (Exception: the line connecting two subpolygons is never drawn, and is not a fill boundary.)

Filling Polygons

There are two methods which can be selected for filling polygons: the **even/odd** fill method and the **non-zero winding** fill method.

Even/Odd Fill Method

There is a simple way to determine which portions of a single polygon or series of subpolygons is filled when you send a Fill Polygon (FP) command using the default method 0, (fill using even/odd rule):

Draw a straight line extending from any point within an enclosed area of the polygon to a point outside the polygon. FP fills the enclosed area in question only if the line you have drawn intersects the edges of the polygon an odd number of times. Figure 21-8 illustrates this 'odd-even' rule.

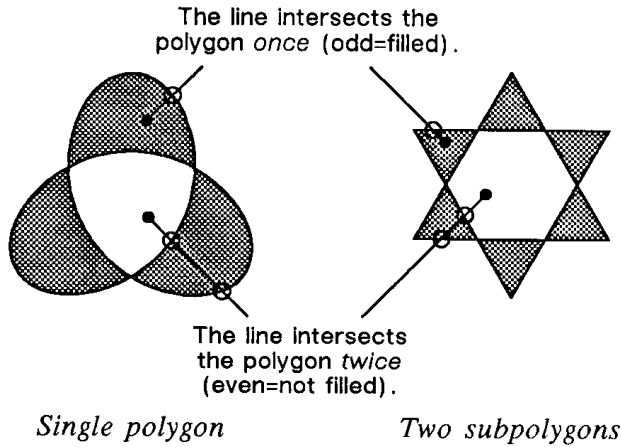

Figure 21-8 Filling Polygons: Even/Odd Fill Method

Non-Zero Winding Fill Method

The *non-zero* winding fill algorithm (fill method 1) determines whether a point is inside a region enclosed by a line path using the following steps:

- 1 Draw a ray from the point across the path segment.
- 2 Add 1 every time the line segment crosses the ray from left to right or bottom to top.
- 3 Subtract 1 every time the segment crosses the ray from right to left or top to bottom.
- 4 FP fills the enclosed area in question if the sum of steps 2 and 3 is non-zero. Figure 21-9 illustrates the non-zero winding fill concept.

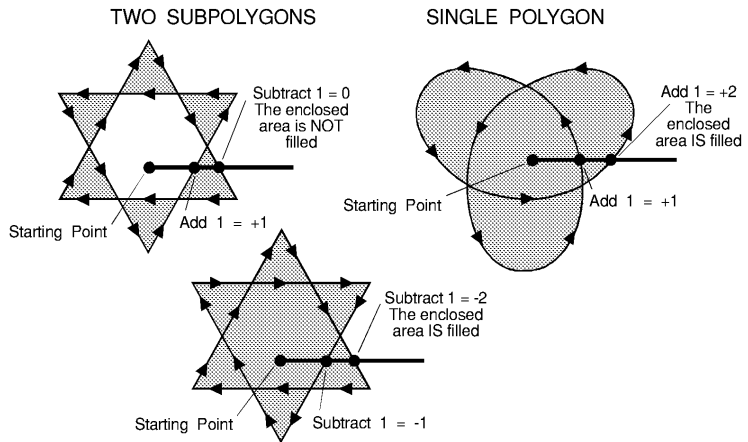

Figure 21-9 Filling Polygons: Non-Zero Winding Fill Method

Drawing Circles in Polygon Mode

Polygon mode interprets the Circle (CI) command differently than the other HP-GL/2 commands. The printer treats a circle as a complete subpolygon. The printer automatically closes the first polygon (if any) before starting the circle, and uses the first coordinates (if any) after the circle is drawn to start a new subpolygon.

If you did not close your first polygon completely before sending the CI command, the printer automatically closes the polygon by adding a point (at the starting point of the previous subpolygon). This can change your current pen location and the placement of the circle in your polygon, resulting in an inaccurate polygon.

Approximating Polygon Buffer Use

You can use the following formula to estimate how much buffer space a polygon consumes. Each point in a polygon uses 8 bytes. For example, the minimum number of points the printer will hold is 512.

If you multiply 512 points by 8 bytes per point, the result is 4096 bytes (4 Kbytes). That means the minimum your printer can store in the polygon buffer is 4 Kbytes. That is the worst case, however. Unless the printer has a substantial amount of fonts, macros, or graphics already downloaded into user memory, you can put much more into the polygon buffer. As we just calculated, for every 4 Kbytes of extra unused user memory, the polygon buffer can store 512 more points. You can see how in most cases there is little chance of a polygon buffer overflow, especially with the addition of optional printer memory.

The following formula explains how to calculate the buffer space used by a polygon:

number of points in polygon \times 8 = buffer space consumed by polygon"

Counting the Points in a Polygon

The starting pen location and each subsequent point define a polygon. As shown in the following illustration, a rectangle is defined by five points, not four. This is because the starting location is counted again as the ending location.

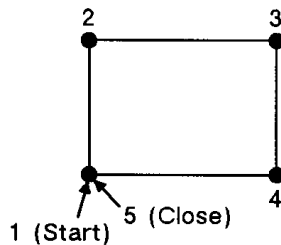

Figure 21-10

The following shape has seven points.

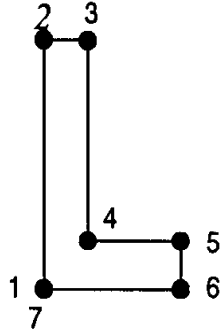

Figure 21-11

Counting the Points in a Circle or Arc

When a circle or arc defines a polygon, the number of points depends on the number of chords in the arc. There is always one more point than the number of chords, because the starting location is counted again as the ending location. Use the following formula to determine the number of points used to draw a circle or arc:

$$\# \text{ of Points} = \frac{\text{Arc Angle (degrees)}}{\text{Chord Angle (degrees)}} + 1$$

Using this formula, a full circle with the default chord angle of 5° consists of 73 points ($360/5 + 1 = 73$), and a 45° arc with a chord angle of 3° consists of 16 points ($45/3 + 1 = 16$).

Notes

If the chord angle does not divide evenly into the arc, round up to the next integer before adding one: $45/2 + 1 = 23 + 1 = 24$.

In polygon mode, the smaller a circle's chord angle, the more chords will be stored in the polygon buffer to draw it.

EA, Edge Rectangle Absolute

This command defines and outlines a rectangle using absolute coordinates. Use EA when drawing charts or schematic diagrams that require rectangles.

EA X,Y[:]

Parameter	Format	Functional Range	Default
X,Y coordinates	current units	-2^{30} to $2^{30} - 1$	no default

The EA command defines and edges a rectangle using absolute coordinates and the current pen, line type and line attributes. The EA command performs an automatic pen down. When the command execution is complete, the original pen location and up/down status are restored.

- **X,Y Coordinates** — Specify the opposite corner of the rectangle from the current pen location. The current pen location is the starting point of the rectangle. Coordinates are interpreted in current units: as user-units when scaling is on; as plotter units when scaling is off.

Note

The following illustration shows the current pen location in the lower left corner and the command's X,Y coordinates in the upper-right corner. Depending on the coordinate values, the points can be in any two diagonally opposite corners.

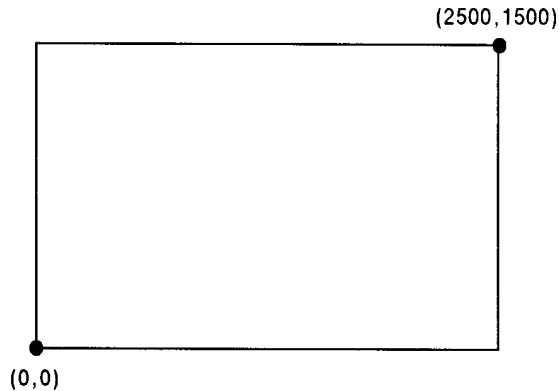

Figure 21-12

Note

Any line drawn along the border of the effective window causes the line to be clipped, producing a line width one-half of the defined pen width. For example, all the lines drawn in the above example are half the width of the other lines since they are clipped at the window borders.

The only difference between the EA command and the RA (Fill Rectangle Absolute) command is that the EA command produces an outlined rectangle, and RA, a filled one.

The EA command clears the polygon buffer and then uses it to define the rectangle before drawing. Refer to *Drawing Polygons* at the beginning of this chapter for more information.

The following example uses absolute coordinates to draw some rectangles. The same image is drawn later using the ER command instead. Compare this example with the ER example to understand the differences between the coordinates used (relative vs. absolute).

Table 21-8 Example: Using EA to Draw Rectangles

?E	Reset the printer.
?%0B	Enter HP-GL/2 mode.
IN;	Initialize HP-GL/2 mode.

Table 21-8 Example: Using EA to Draw Rectangles (continued)

SP1;	Select pen number 1. Even though there is no physical pen, the SP command must be used to enable printing.
SC0,150,0,150,1;	Set up user scaling, with P1 being (0,0) user-units and P2 being (150,150) user-units. (Isotropic scaling is specified.)
PA75,105; EA115,130;	Specify absolute plotting mode and move to (75,105). Use EA to outline the shape of a rectangle that begins at (75,105) and has an upper right corner of (115,130) user-units.
PA95,105;PD95,95;	Draw a line from (95,105) to (95,95).
PD65,95,65,90;	Draw a line from the current pen location (95,95) to (65,95), and another line from there to (65,90).
PU45,90;EA85,65;	Lift the pen and move to (45,90). Draw the outline of a rectangle with an upper left corner of (45,90) and a lower right corner of (85,65).
PU95,95;PD125,95,125,90;	Lift the pen and move to (95,95). Lower the pen and draw a line to (125,95), then to (125,90).
PU145,90;EA105,65;	Lift the pen and move to (145,90). Draw the outline of a rectangle, with the upper right corner at (145,90) and the lower left corner at (105,65).
?%0A	Enter the PCL mode.
?E	Send a reset to end the job and eject the page.

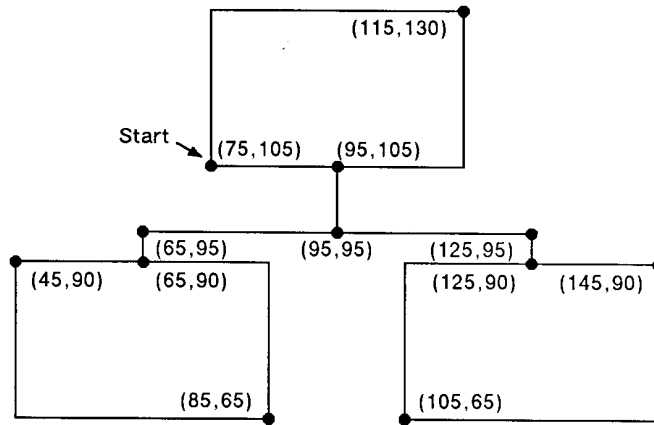

Figure 21-13

Table 21-9

Related Commands	Group
EP, Edge Polygon ER, Edge Rectangle Relative FP, Fill Polygon RA, Fill Rectangle Absolute RR, Fill Rectangle Relative	<i>The Polygon Group</i>
LA, Line Attributes LT, Line Type PW, Pen Width	<i>The Line and Fill Attributes Group</i>

EP, Edge Polygon

This command outlines the polygon currently stored in the polygon buffer. Use EP to edge polygons that you defined in polygon mode and with the Fill Rectangle and Wedge Commands (RA, RR, and WG).

EP [;]

The EP command outlines any polygon that is currently in the polygon buffer. This includes wedges and rectangles defined using the EA, ER, EW, RA, RR, and WG commands. EP accesses the data in the polygon buffer, but does not clear the buffer or change the data in any way.

The EP command only edges between points that were defined with the pen down, using the current pen, line type and attributes. When the command execution is complete, the original pen location and up/down status are restored.

The following example creates a shape in polygon mode, then uses EP to outline it.

Table 21-10 Example: Using the EP Command

?E	Reset the printer.
?%0B	Enter HP-GL/2 mode.
IN;	Initialize HP-GL/2 mode.
SP1;	Select pen number 1 (black).
PA2000,10;	Specify absolute plotting and move to position (2000,10).
PM0;PD10,2000,10,10,2000,10;PM1;	Enter polygon mode, store a pen down command, and then store points (10,2000), (10,10), and (2000,10). Close the polygon.
PU610,610; CI500;PM2;	While still in polygon mode, lift the pen and move to (610,610). Draw a circle with a diameter of 500 plu, then close the current subpolygon and exit polygon mode.

Table 21-10 Example: Using the EP Command (continued)

EP;	Outline the polygon that was just stored in the polygon buffer.
?%0A	Enter the PCL mode.
?E	Send a reset to end the job and eject the page.

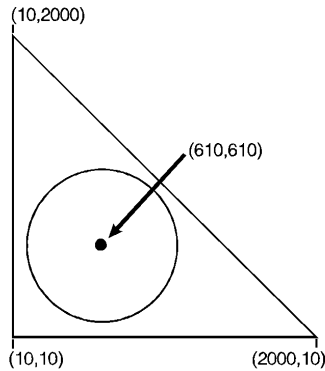

Figure 21-14

Table 21-11

Related Commands	Group
EA, Edge Rectangle Absolute ER, Edge Rectangle Relative EW, Edge Wedge PM, Polygon Mode RA, Fill Rectangle Absolute RR, Fill Rectangle Relative WG, Fill Wedge	<i>The Polygon Group</i>
LA, Line Attributes LT, Line Type PW, Pen Width	<i>The Line and Fill Attributes Group</i>

ER, Edge Rectangle Relative

This command defines and outlines a rectangle using relative coordinates. Use ER when drawing charts or schematic diagrams that require rectangles.

ER X,Y[:]

Parameter	Format	Functional Range	Default
X,Y increments	current units	-2^{30} to $2^{30} - 1$	no default

The ER command defines and edges a rectangle using relative coordinates and the current pen, line type, and line attributes. The ER command includes an automatic pen down. When the command operation is complete, the original pen location and up/down status are restored.

- **X,Y Increments** — Specify the opposite corner of the rectangle from the current pen location. The current pen location is the starting point of the rectangle. Increments are interpreted in current units: as user-units when scaling is on; as plotter units when scaling is off.

Note

The following illustration shows the current pen location in the lower left corner and the command's X,Y increment location in the upper right corner. When drawing a rectangle, these points can be in any two diagonally opposite corners.

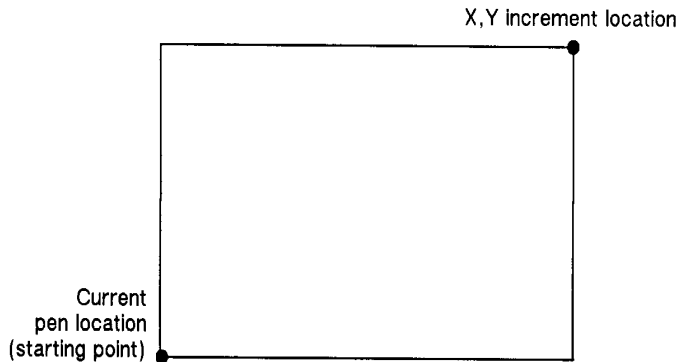

Figure 21-15 Edge Relative Rectangle Command

The only difference between the ER command and the RR (Fill Relative Rectangle) command is that the ER command produces an outlined rectangle, and RR, a filled one.

The ER command clears the polygon buffer and then uses it to define the rectangle before drawing. Refer to “Drawing Polygons” earlier in this chapter for more information.

The following example uses relative coordinates to draw the same image shown in the EA command example. Compare this example with the EA example to understand the differences between the coordinates used.

Table 21-12 Example: Using ER to Draw Rectangles

?E	Reset the printer.
?%0B	Enter HP-GL/2 mode.
IN;	Initialize HP-GL/2 mode.
SP1;	Select pen number 1. The SP command must be used to enable printing.
SC0,150,0,150,1;	Specify user scaling, with P1 being (0,0) and P2 (150,150); the “1” indicates isotropic scaling.

Table 21-12 Example: Using ER to Draw Rectangles (continued)

PA75,105;ER40,25;	Enter absolute plotting mode and move to (75,105). Draw a rectangle using the current pen location as the lower left corner and a point (40,25) user-units away as the upper right corner.
PR20,0;PD0,-10;	Specify relative plotting and move the pen 20 user-units to the right. Place the pen down and draw a line to a point 10 user-units down.
PD-30,0,0,-5;	With the pen down, move 30 user-units to the left and 5 units down.
PU-20,0;ER40,-25;	Lift the pen and move 20 user-units to the left, then draw the outline of a rectangle with the current pen location as one corner and a point (40,-25) user-units away as the opposite corner.
PU50,5;PD30,0,0,-5;	Lift the pen and move 50 user-units to the right and 5 units up. Place the pen down and draw a line 30 user-units to the right, then 5 units down.
PU20,0;ER-40,-25;	Lift the pen and move 20 user-units to the right. Draw a rectangle from that point, with the current pen location being one corner and the opposite corner being 40 user-units to the left and 25 units down.
?%0A	Enter the PCL mode.
?E	Send a reset to end the job and eject the page.

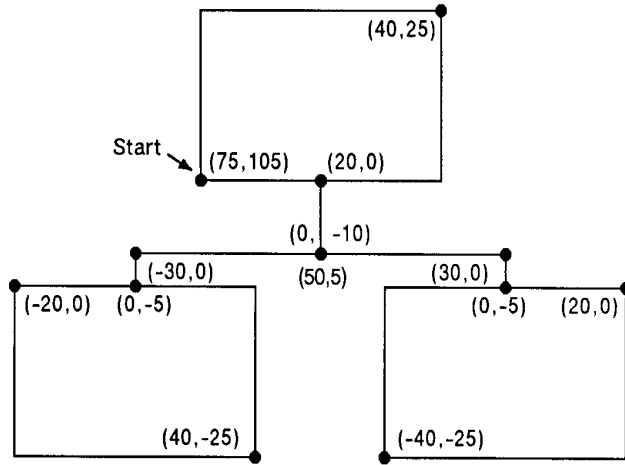

Figure 21-16

Table 21-13

Related Commands	Group
EA, Edge Rectangle Absolute EP, Edge Polygon FP, Fill Polygon RA, Fill Rectangle Absolute RR, Fill Rectangle Relative	<i>The Polygon Group</i>
LA, Line Attributes LT, Line Type PW, Pen Width	<i>The Line and Fill Attributes Group</i>

EW, Edge Wedge

This command outlines any wedge. Use EW to draw sections of pie charts.

EW *radius,start angle,sweep angle,[,chord angle;]*

Parameter	Format	Functional Range	Default
radius	current units	-2^{30} to $2^{30} - 1$	no default
start angle	clamped real	-32768 to 32767	no default
		modulo 360	
sweep angle	clamped real	$\pm 360^\circ$	no default
chord angle	clamped real	0.5° to 180°	5°

The EW command defines and edges a wedge using the current pen, line type and attributes. The EW command includes an automatic pen down. When the command execution is complete, the original pen location and up/down status are restored.

The only difference between the EW command and the WG (Fill Wedge) command is that the EW command produces an outlined wedge, and the WG command, a filled one.

Always use isotropic scaling in drawings that contain wedges unless you wish the wedges to “stretch” with changes in the aspect ratio of the drawing (causing elliptical wedges). For more information, refer to the discussion of scaling and the Scale (SC) command description in Chapter 19.

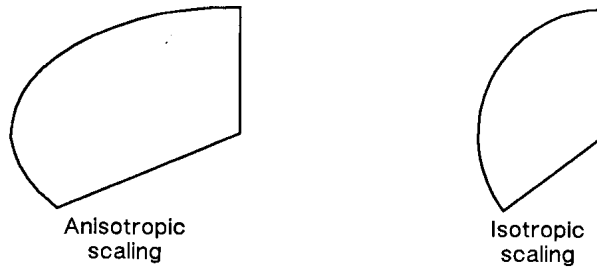
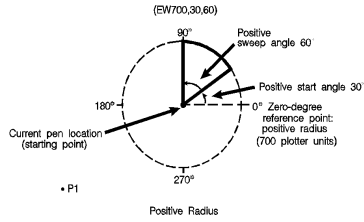

Figure 21-17 Anisotropic and Isotropic Scaling

- **Radius** — Specifies the distance from the current pen location to the start of the wedge's arc. Since the wedge is a portion of a circle, this parameter is the radius of the circle. It specifies the distance from the current pen location (which becomes the center of the circle), to any point on the circumference of the circle.

The radius is interpreted in current units: as user-units when scaling is on; as plotter units when scaling is off. The sign (positive or negative) of the radius determines the location of the zero-degree reference point. The illustration following the parameter descriptions shows the location of the zero-degree reference point for a positive and a negative radius.
- **Sweep Angle** — Specifies the number of degrees through which the arc is drawn. A positive sweep angle is in the direction of the +X-axis to the +Y-axis; a negative sweep angle is in the direction of the +X-axis to the -Y-axis. However, the relative position of the +X-axis to the +Y-axis can change as a result of scaling point or scaling factor changes, thus, changing the direction of the sweep angle. Also, if you specify a start angle greater than 360°, a start angle equal to the remainder of the start angle/360° is used.
- **Chord Angle** — Specifies the chord angle used to draw the arc. The default is a chord angle of 5 degrees. Refer to the Arc Absolute (AA) command discussion in Chapter 20 for further information on chords and chord angles.

• P2



• P2

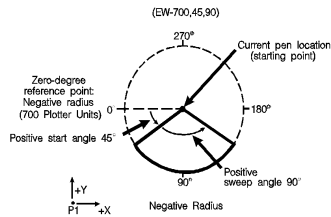

Figure 21-18

Table 21-14 Example: Using EW to Draw a Pie Chart

?E	Reset the printer.
?%0B	Enter HP-GL/2 mode.
IN;	Initialize HP-GL/2 mode.
SP1;	Select pen number 1. Even though there is no physical pen, the SP command must be used to enable printing.
SC-3000,3000,-2000,2000,1;	Enter the scaling mode, specifying P1 as (-3000,-2000) and P2 as (3000,2000). Use isotropic scaling.
PA0,0;	Specify absolute plotting and move to user-unit location (0,0).
EW-1000,90,180;	Draw a wedge section with a radius of 1000 user-units, a start angle of 90°, and a sweep angle of 180°. The minus sign before the radius (-1000) sets the zero-degree reference point to the left side of the drawing.

Table 21-14 Example: Using EW to Draw a Pie Chart

EW-1000, 330,120;	Using the same center point and zero-degree reference point, draw a wedge section outline starting at 330° and sweeping 120°.
PR-60,110;	Move the cursor 60 user-units to the left and 110 user-units up.
EW-1000,270,60;	From the new center point location, draw a wedge using a negative zero-reference point, starting at 270° and sweeping for 60°.
?%0A	Enter the PCL mode.
?E	Send a reset to end the job and eject the page.

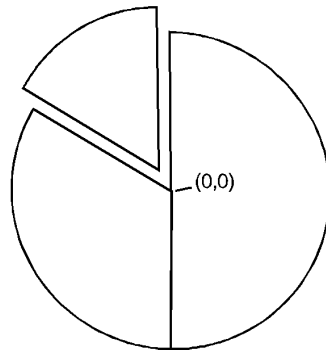

Figure 21-19

Table 21-15

Related Commands	Group
EP, Edge Polygon FP, Fill Polygon WG, Fill Wedge	<i>The Polygon Group</i>
SC, Scale	<i>The Configuration/Status Group</i>
CI, Circle	<i>The Vector Group</i>
LA, Line Attributes	<i>The Line and Fill Attributes Group</i>

Table 21-15 (continued)

LT, Line Type	
PW, Pen Width	

Table 21-16 Possible Error Conditions

Condition	Printer Response
polygon buffer overflow	edges contents of buffer

FP, Fill Polygon

This command fills the polygon currently in the polygon buffer. Use FP to fill polygons defined in polygon mode or with the Edge Rectangle or Edge Wedge commands (EA, ER, EW, RA, RR, or WG).

FP *fill method* [;]

or

FP [;]

Parameter	Format	Functional Range	Default
fill method	clamped integer	0 or 1	0 (odd-even fill)

- **Fill Method** — Specifies the algorithm used to determine which portions of the polygon are “inside” the polygon and therefore are to be filled:
 - 0 -- Even/odd fill algorithm (default)
 - 1 -- Non-zero winding fill algorithm

Note

Even/odd (method 0) and **Non-zero** (method 1) winding fill methods are described in detail under “Filling Polygons,” earlier in this chapter.

The FP command fills any polygon that is currently in the polygon buffer. FP accesses the data in the polygon buffer, but does *not* clear the buffer or change the data in any way.

The FP command fills between points defined with either the pen down or the pen up. The polygon is filled using the current pen, fill type, line type and attributes (if the fill type is not raster). The FP command includes an automatic pen down. When the command execution is complete, the original pen location and up/down status are restored.

The example on the next page creates a polygon composed of two subpolygons. In this case, the FP command fills alternating areas, beginning with the outside area.

Table 21-17 Example

?E	Reset the printer.
?%0B	Enter HP-GL/2 mode.
IN;	Initialize HP-GL/2 mode.
SP1;	Select pen number 1. Even though there is no physical pen, the SP command must be used to enable printing.
PA1500,1500;	Specify absolute plotting and move to (1500,1500).
PM0;CI1000,60; PA1500,1500; CI500;PM2;	Enter the polygon mode, store a circle with radius of 1000 plu and a 60° chord angle, store a pen move to (1500,1500), and another circle with a 500 plu radius and a 5° (default) chord angle. Close the current polygon and exit polygon mode.
LT4;FT3,50,45;	Select line type 4 and fill type 3. Specify a 50 plu distance between the fill lines, and slant the lines at a 45° angle.
FP;	Using even-odd fill method, fill the polygon currently in the polygon buffer with the line and fill types just specified.
?%0A	Enter the PCL mode.
?E	Send a reset to end the job and eject the page.

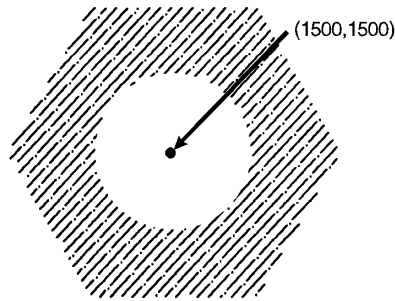

Figure 21-20

Table 21-18

Related Commands	Group
EA, Edge Rectangle Absolute ER, Edge Rectangle Relative EW, Edge Wedge PM, Polygon Mode RA, Fill Rectangle Absolute RR, Fill Rectangle Relative WG, Fill Wedge	<i>The Polygon Group</i>
FT, Fill Type LA, Line Attributes LT, Line Type PW, Pen Width	<i>The Line and Fill Attributes Group</i>

PM, Polygon Mode Command

This command enters polygon mode for defining shapes, such as block letters or any unique area, and exits for subsequent filling and/or edging. Fill polygons using the Fill Polygon (FP) command and/or outline them using the Edge Polygon (EP) command.

PM *polygon definition* [:]

or

PM [:]

Parameter	Format	Functional Range	Default
polygon definition	clamped integer	0, 1, and 2	0

In polygon mode, you define the area of the polygon(s) using graphics commands. These commands (and associated X,Y coordinates) are stored in the polygon buffer. The polygon is not printed until you exit polygon mode and fill and/or outline the area.

- **No Parameters** — Clears the polygon buffer and enters polygon mode. Equivalent to (PM0).
- **Polygon Definition** — Defines polygon mode status as follows.
 - **0** — Clears the polygon buffer and enters polygon mode.
 - **1** — Closes the current polygon (or subpolygon) and remains in polygon mode; all commands sent following PM1 but before a PM2 (or the next PM1) are stored as one subpolygon.
 - **2** — Closes current polygon (or subpolygon) and exits polygon mode.

The following paragraphs explain how to use each parameter. The order in which you use these commands is very important.

(PM0) or (PM)

Use (PM0) to clear the polygon buffer and enter polygon mode. While in polygon mode, only certain commands are allowed. The following list contains these commands:

Table 21-19

Polygon Mode Allowable Commands	Group
DF, Default Values IN, Initialize	<i>The Configuration/Status Group</i>
AA, Arc Absolute AR, Arc Relative AT, Absolute Arc Three Point BR, Bezier Relative BZ, Bezier Absolute CI, Circle PA, Plot Absolute PD, Pen Down PE, Polyline Encoded PR, Plot Relative PU, Pen Up RT, Relative Arc Three Point	<i>The Vector Group</i>
PM1/PM2, Polygon Mode	<i>The Polygon Group</i>

The polygon buffer stores the lines (vectors) that define your polygon. These vectors are accessed later when you exit polygon mode and fill and/or edge the polygon.

Note

While in polygon mode, the CI command is interpreted differently than other graphics commands. Refer to “Drawing Circles in Polygon Mode,” earlier in this chapter for more details.

When you define a polygon, the pen location before the *PM0* command is the first point (vertex) of the polygon, and the first point stored in the polygon buffer. For example, if you execute the

commands (*PA0,1750;PM0*), the absolute coordinates (0,1750) specify the first point of your polygon. Each subsequent pair of coordinates defines a point, or vertex, of the polygon.

You can define points with the pen up or down. However, the EP command only draws between points that are defined when the pen is down. On the other hand, the FP command fills the area(s) between all vertices, regardless of whether the pen is up or down when defined.

It is good programming practice to 'close' the polygon before exiting polygon mode. Closing a polygon means adding the final vertex that defines a continuous shape; the last coordinates or increments represent the same location as the

first. If you have not closed the polygon, executing (*PM1*) or (*PM2*) forces closure by adding a point to close the polygon.

You can also use the Initialize (IN) or Default Values (DF) commands while in polygon mode. Both commands exit polygon mode, clear the polygon buffer, and begin executing subsequent commands immediately. You must exit polygon mode to execute other HP-GL/2 graphics commands.

Note

Sending an ?E while in polygon mode causes the printer to exit polygon mode, clear the polygon buffer, exit HP-GL/2 mode, and eject a page. Sending an ?E while in polygon mode is not recommended, but it performs an important function (allowing you to recover from a previous job that left the printer in polygon mode).

(PM1)

Use (*PM1*) to close the current polygon (or subpolygon) and remain in polygon mode; the printer adds a closure point if necessary. When you use (*PM1*), the point after (*PM1*) becomes the first point of the next subpolygon. This move is not used as a boundary when filling a polygon with FP. When drawing the polygon, the pen always moves to this point in the up position, regardless of the current pen status. Each subsequent coordinate pair after (*PM1*) defines a point of the subpolygon.

(PM2)

Use (PM2) to close the current polygon (or subpolygon) and exit polygon mode. Remember, if you have not closed your polygon, executing (PM2) adds a point to close the polygon. Refer to “Pen Status and Location” in Chapter 17, *Introduction to HP-GL/2 Graphics*.

The following example draws the surface area of a 3-prong electrical receptacle as a series of subpolygons, then fills and edges it using the FP and EP commands, respectively.

Table 21-20 Example: Using the PM Command

?E	Reset the printer.
?%0B	Enter HP-GL/2 mode.
IN;	Initialize HP-GL/2 mode.
SP1;	Select pen number 1. Even though there is no physical pen, the SP command must be used to enable printing.
PA2000,2000;	Specify absolute plotting and move to (2000,2000).
PM0;PD3000,2000,3000,3000;	Enter polygon mode, store a Pen Down command, and store locations (3000,2000) and (3000,3000).
PD2000,3000,2000,2000;	Store two more pen-down locations, (2000,3000) and (2000,2000).
PM1;	Close the first polygon.
PD2080,2160,2480,2160,2480,2340,2080,2340,2080,2160;	Store 5 pen-down locations for a subpolygon.
PM1;	Close the subpolygon.
PD2080,2660,2480,2660,2480,2840,2080,2840,2080,2660;	Store pen-down locations for another subpolygon.
PM1;	Close the second subpolygon.

Table 21-20 Example: Using the PM Command (continued)

PD2920,2340,2920, 2660,2720,2660;	Begin a third subpolygon that draws the ground plug portion of the receptacle.
AA2720,2500,180; PD2920,2340;	Store a 180° arc that goes from (2720,2660) to (2720,2500).
PM2;FP;EP;	Close the subpolygon and exit polygon mode. Fill (even/odd), then edge the polygon and subpolygons currently stored in the buffer.
?%0A	Enter the PCL mode.
?E	Send a reset to end the job and eject the page.

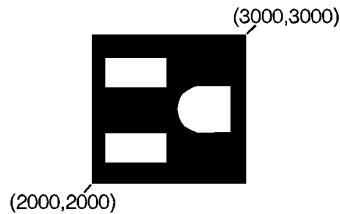

Figure 21-21

Table 21-21

Related Commands	Group
EP, Edge Polygon FP, Fill Polygon	<i>The Polygon Group</i>

RA, Fill Rectangle Absolute

This command defines and fills a rectangle using absolute coordinates. Use RA to fill rectangular shapes in drawings. (To outline a rectangle using absolute coordinates, use the EA command.)

RA X,Y[:]

Parameter	Format	Functional Range	Default
X,Y coordinates	current units	-2^{30} to $2^{30} - 1$	no default

The RA command defines and fills a rectangle using the current pen, the current line and fill types, and absolute X,Y coordinates. The RA command includes an automatic pen down. When the command operation is complete, the original pen location and up/down status are restored.

- **X,Y Coordinates** — Specify the corner of the rectangle that is diagonally opposite from the current pen location (the starting point of the rectangle). Coordinates are interpreted in current units: as user-units when scaling is on; as plotter units when scaling is off.

Note

The following illustration shows the current pen location in the lower-left corner and the command's X,Y coordinates in the upper-right corner. Depending on the X,Y coordinates used, these points can be in any two diagonally opposite corners.

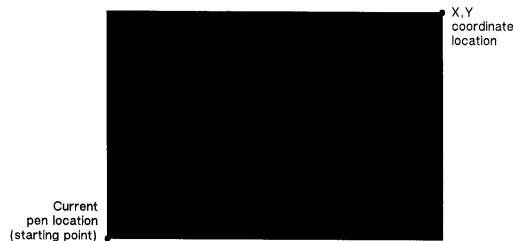

Figure 21-22 Fill Rectangle Absolute

The only difference between the RA command and the EA (Edge Rectangle Absolute) command is that the RA command produces a filled rectangle, and EA, an outlined one.

The RA command clears the polygon buffer and then uses it to define the rectangle before drawing. Refer to “Using the Polygon Buffer” earlier in this chapter.

The following example uses RA with three different fill types to create rectangles such as those you might use in a bar chart. The rectangles in the right bar are edged using the EA command. (For more information about fill types, refer to the FT command description in Chapter 22.)

Table 21-22 Example: Using the RA Command with Different Fill Types

?E	Reset the printer.
?%0B	Enter HP-GL/2 mode.
IN;	Initialize HP-GL/2 mode.
SP1;	Select pen number 1. Even though there is no physical pen, the SP command must be used to enable printing.
PA400,400; RA800,1200;	Enter absolute plotting mode and move to (400,400). Draw a rectangle with (400,400) as the lower left corner and (800,1200) as the upper right corner.
PA400,1200;FT3, 50;RA800,1600;	Move the pen to (400,1200), select fill type 3 (parallel lines) with a 50 plu space between lines, and draw a rectangle with (400,1200) as the lower left corner and (800,1600) as the upper right corner.
PA400,1600;FT4; RA800,2000;	Move to (400,1600) and specify fill type 4 (cross-hatching). Draw a rectangle with a lower left corner of (400,1600) and an upper right corner of (800,2000).
PA1200,400;FT; RA1600,1200; EA1600,1200;	Move to location (1200,400) and select the default fill type (solid black). Fill and edge a rectangle using (1200,400) as the lower left corner and (1600,1200) as the upper right corner.

Table 21-22 Example: Using the RA Command with Different Fill Types (continued)

PA1200,1200;FT3 , 50;RA1600,1600; EA1600,1600;	Move to absolute position (1200,1200) and select fill type 3, with a 50 plu distance between each line. Draw a rectangle with (1200,1200) as the lower left corner and (1600,1600) as the upper right. Using the default line type, edge the rectangle just drawn.
PA1200,1600;FT4 ; RA1600,2000; EA1600,2000;	Move to (1200,1600) and select the cross-hatch pattern fill type. Draw a rectangle with the current pen location as one corner and (1600,2000) as the opposite corner.
?%0A	Enter the PCL mode.
?E	Send a reset to end the job and eject the page.

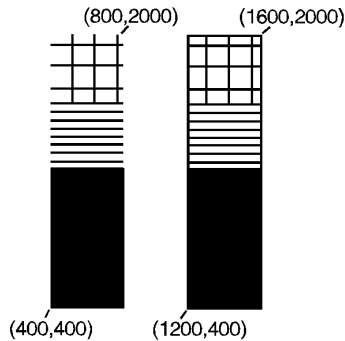

Figure 21-23

Table 21-23

Related Commands	Group
EA, Edge Rectangle Absolute EP, Edge Polygon ER, Edge Rectangle Relative FP, Fill Polygon RR, Fill Rectangle Relative	<i>The Polygon Group</i>

Table 21-23 (continued)

FT, Fill Type	<i>The Line and Fill Attributes Group</i>
LT, Line Type	
RF, Raster Fill Definition	

RR, Fill Rectangle Relative

This command defines and fills a rectangle using relative coordinates. Use RR to fill rectangular shapes in drawings. (To outline a rectangle using relative coordinates, use the ER command.)

RR X,Y[;]

Parameter	Format	Functional Range	Default
X,Y increments	current units	-2^{30} to $2^{30} - 1$	no default

The RR command defines and fills a rectangle using the current pen, the current line and fill types, and relative coordinates. The RR command includes an automatic pen down. After the command is executed, the original pen location and up/down status are restored.

- **X,Y Increments** — Specify the corner of the rectangle that is diagonally opposite from the current pen location, which is the starting point of the rectangle. Coordinates are interpreted in current units: as user-units when scaling is on; as plotter units when scaling is off.

Note

The following illustration shows the current pen location in the lower-left corner and the command's X,Y increments in the upper-right corner. However, these points can be in any two opposite corners depending on the coordinates used.

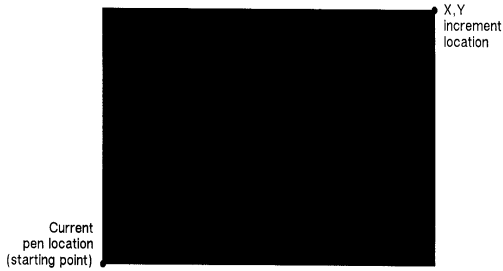

Figure 21-24 Fill Rectangle Relative

The only difference between the RR command and the ER (Edge Relative Rectangle) command is that the RR command produces a filled rectangle, and ER, an outlined one.

The RR command clears the polygon buffer and then uses it to define the rectangle before drawing. A rectangle requires enough buffer space to hold five points.

The following example uses RR with three different fill types (refer to the FT command description) to create rectangles such as those you might use in a bar chart. The rectangles in the right bar are edged using the ER command.

Table 21-24 Example: Using the RR Command with Different Fill Types

?E	Reset the printer.
?%0B	Enter HP-GL/2 mode.
IN;	Initialize HP-GL/2 mode.
SP1;	Select pen number 1. Even though there is no physical pen, the SP command must be used to enable printing.
PA400,400; RR400,800;	Specify absolute plotting and move to location (400,400). Fill a rectangle with the default fill (black), with (400,400) as the lower left corner and the upper right corner 400 plu to the right and 800 plu up from there.

Table 21-24 Example: Using the RR Command with Different Fill Types (continued)

PR0,800;FT3,50; RR400,400;	Enter the relative plotting mode and move 800 plu in the Y direction and select fill type 3 (parallel lines). Draw a rectangle using the current pen location as the lower left corner; the upper right corner is 400 plu to the right and 400 plu up from the lower left corner.
PR0,400;FT4; RR400,400;	Move 400 plu up and select fill type 4 (cross-hatching). Draw a rectangle using the current pen position as the lower left corner and a point 400 plu to the right and 400 plu up as the upper right corner.
PA1200,400;FT; RR400,800; ER400,800;	Move to absolute location (1200,400) and select the default fill type (solid black). Draw and edge a rectangle that begins at the current pen position and extends 400 plu to the right, then 800 plu up from there.
PR0,800;FT3,50; RR400,400; ER400,400;	Move 800 plu up from the current position and select fill type 3 (parallel lines), with 50 plu between each line. Draw a rectangle using the current pen location as the lower left corner and a point 400 plu up and 400 plu to the right as the upper right corner. Edge the rectangle.
PR0,400;FT4; RR400,400; ER400,400;	Move 400 plu up from the current pen position. Select fill type 4 (cross-hatching). Draw a rectangle using the current pen location as the lower left corner, the right corner being (400,400) relative plotter units away.
?%0A	Enter the PCL mode.
?E	Send a reset to end the job and eject the page.

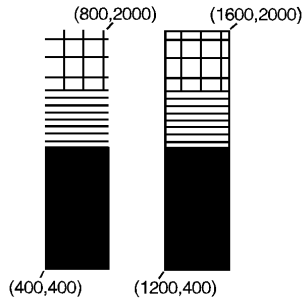

Figure 21-25

Table 21-25

Related Commands	Group
EA, Edge Rectangle Absolute EP, Edge Polygon ER, Edge Rectangle Relative FP, Fill Polygon RA, Fill Rectangle Absolute	<i>The Polygon Group</i>

WG, Fill Wedge

This command defines and fills any wedge. Use WG to draw filled sections of a pie chart.

WG *radius,start angle,sweep angle[,chord angle;]*

Parameter	Format	Functional Range	Default
radius	current unit	-2^{30} to $2^{30} - 1$	—
start angle	clamped real	-32768 to 32767	—
sweep angle	clamped real	$\pm 360^\circ$	—
chord angle	clamped real	0.5° to 180°	5°

The WG command defines and fills a wedge using the current pen, fill type, and line types. The WG command includes an automatic pen down. When the command operation is complete, the original pen location and up/down status are restored.

The only difference between the WG command and the EW (Edge Wedge) command is that the WG command produces a filled wedge, and the EW, an outlined one.

Always use isotropic scaling in any drawing that contains wedges (to avoid drawing an elliptical wedge). (Refer to the discussion of scaling in Chapter 17 for more information.)

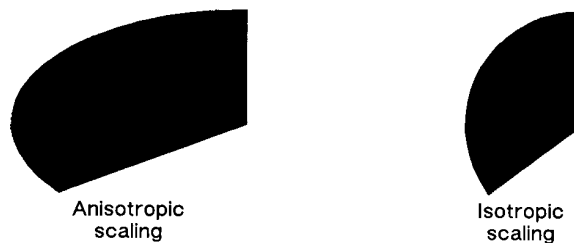
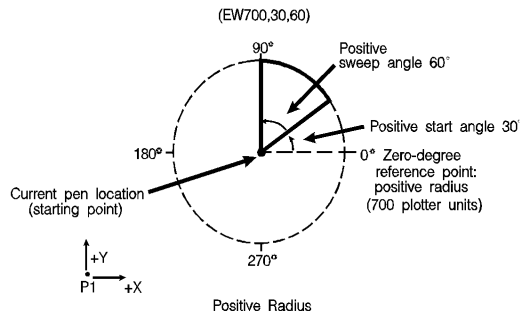

Figure 21-26 Fill Wedge with Scaling

- **Radius** — Specifies the distance from the current pen location to the start of the wedge's arc. Since the wedge is a portion of a circle, this parameter is the radius of the circle. It specifies the distance from the current pen location (which becomes the center of the circle), to any point on the circumference of the circle.
 - The radius is interpreted in current units: as user-units when scaling is on; as plotter units when scaling is off. The sign of the radius (+ or -) determines the location of the zero-degree reference point. The illustration following the parameter descriptions shows the location of the zero-degree reference point for a positive and negative radius.
- **Start Angle** — Specifies the beginning point of the arc as the number of degrees from the zero-degree reference point. A positive start angle positions the radius in the positive direction (the direction from the +X-axis toward the +Y-axis) from the zero-degree reference point; a negative start angle positions the radius in a negative direction from the zero-degree reference point. If you specify a start angle greater than 360°, a start angle equal to the remainder of the start angle/360° is used.

- Sweep Angle** — Specifies in degrees the angle through which the arc is drawn. A positive angle draws the angle in the positive direction (angle of rotation - +X-axis to the +Y-axis); a negative angle draws the angle in the negative direction (+X-axis to the - Y-axis). (Note, the relation of the +X-axis to the +Y-axis/-Y-axis can change as a result of scaling point or scaling factor changes.) If a sweep angle greater than 360 degrees is specified, a 360-degree angle is used.
- Chord Angle** — Specifies the chord angle used to define the arc. The default is 5 degrees. Refer to the “Chord Angle” discussion in the Arc Absolute (AA) command discussion (Chapter 20) for information on setting the chord angle.

• P2



• P2

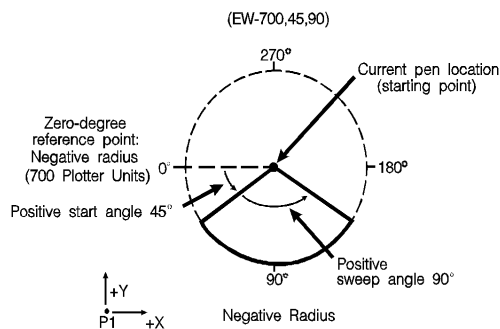

Figure 21-27

Table 21-26 Example: Filling then Edging vs. Edging then Filling Chart

?E	Reset the printer.
?%0B	Enter HP-GL/2 mode.
IN;	Initialize HP-GL/2 mode.
SP1;	Select pen number 1. Even though there is no physical pen, the SP command must be used to enable printing.
SC-3000,3000, -2000,2000,1;	Set up user scaling, with P1 being (-3000,-2000) and P2 being (3000,2000). Specify isotropic scaling.
PA0,0;FT3,75,45; WG-1000,90,180;	Enter absolute plotting mode and move to user-unit position (0,0). Select fill type 3 (parallel lines), with 75 user-units between lines and the lines slanted 45°. Fill a wedge with the current fill pattern; use a radius of 1000 user-units, a starting angle of 90° and a sweep angle of 180°. The zero-degree reference point is on the left side of the circle (indicated by the negative radius parameter [-1000]).
EW-1000,90,180;	Draw an outline (edge) around the same wedge.
FT4,60,45; WG-1000,330,120;	Select fill type 4 (cross-hatching), specifying 60 user-units between lines and with the lines tilted at 45°. Fill a wedge that has the same radius and center point, but with a starting angle of 330° and a sweep angle of 120°.
EW-1000,330,120;	Edge the same wedge.
PR-60,110;FT1;	Specify relative plotting and move the pen 60 user-units to the left and 110 units up. Select fill type 1 (solid black).
WG-1000,270,60;	Fill a wedge with a radius of 1000 user-units, a start angle of 270°, and a sweep angle of 60°.
EW-1000,270,60;	Edge the outline of the wedge that was just filled.

Table 21-26 Example: Filling then Edging vs. Edging then Filling Chart (continued)

?%0A	Enter the PCL mode.
?E	Send a reset to end the job and eject the page.

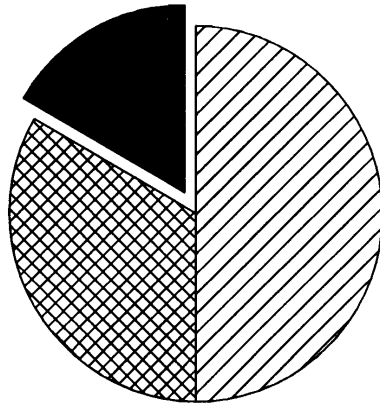

Figure 21-28

The center point of the above circle is located at (0,0).

Note

When transparency mode (TR command) is opaque, filling then edging an object may produce different results from edging and then filling. This is especially true when large pen widths are used. The following example illustrates this.

Table 21-27 Example:

?E	Reset the printer.
?%0B	Enter HP-GL/2 mode.
IN;	Initialize HP-GL/2 mode.
SP1;	Select printer logical pen number 1.
TR0;	Set transparency mode OFF (opaque)
PU4000,6000;	Position pen.

Table 21-27 Example: (continued)

PW5;	Select pen width of 5 units.
PM0;	Enter polygon mode.
CI1000;	Draw a circle with a radius of 1000 units.
PM2;	Close polygon and exit polygon mode.
FT10,30;	Select 30% shading fill type.
FP;EP;	Fill then Edge polygon.
PU4000,3000;	Select pen position (4000, 3000) for second circle.
PM0;	Enter polygon mode.
CI1000;	Draw another circle with a radius of 1000 units.
PM2;	Close polygon and exit polygon mode.
EP;FP;	Edge then fill polygon (circle).
?%0A	Enter the PCL mode.
?E	Send a reset to end the job and eject the page.

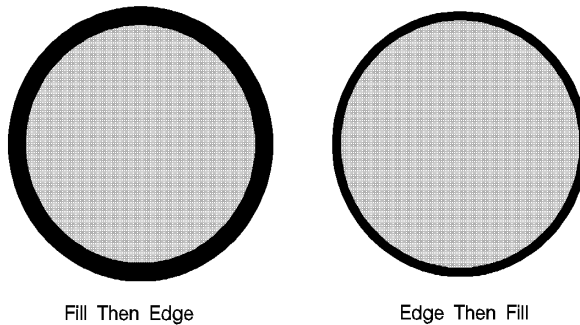

Figure 21-29

The center of the left circle is located at (4000,3000). The center of the right circle is located at (4000,6000).

Table 21-28

Related Commands	Group
EP, Edge Polygon EW, Edge Wedge	<i>The Polygon Group</i>
SC, Scale	<i>The Configuration/Status Group</i>
CI, Circle	<i>The Vector Group</i>
FP, Fill Polygon	<i>The Polygon Group</i>
FT, Fill Type	<i>The Line and Fill Attributes Group</i>

22 The Line and Fill Attributes Group

Introduction

The information in this chapter enables you to achieve the following results in your HP-GL/2 applications:

- Enhance your drawings with various line types.
- Enhance your drawings with different fill types.
- Position fill type patterns.

The following commands are described in this chapter:

Table 22-1 The Line and Fill Attribute Commands

Command	Summary
AC, Anchor Corner	Specifies the starting point for fill patterns.
FT, Fill Type	Selects the pattern to use when filling polygons.
LA, Line Attributes	Specifies how line ends and joins are shaped.
LT, Line Type	Selects the line pattern to use for drawing lines.
PW, Pen Width	Specifies a new pen width.
RF, Raster Fill Definition	Defines a pattern for use as area fill.
SM, Symbol Mode	Draws a symbol at each coordinate location.
SP, Select Pen	Selects a pen for plotting.

Table 22-1 The Line and Fill Attribute Commands

SV, Screened Vectors	Selects the type of area fill to be applied to vectors (lines, cross-hatch lines, arcs, circles, edges of polygons, rectangles, and wedges).
TR, Transparency Mode	Defines how the white areas of the source graphics image affect the destination graphics image.
UL, User-Defined Line Type	Defines a line pattern.
WU, Pen Width Unit Selection	Specifies whether the pen width is defined in millimeters or as a percentage of the P1/P2 distance.

Using Line Attributes and Types

You can change the appearance of the lines you draw by using the Line Attribute (LA) and Line Type (LT) commands. The Line Attribute command lets you specify whether the ends of lines and corners of joined lines should appear as square, triangular, round, or beveled.

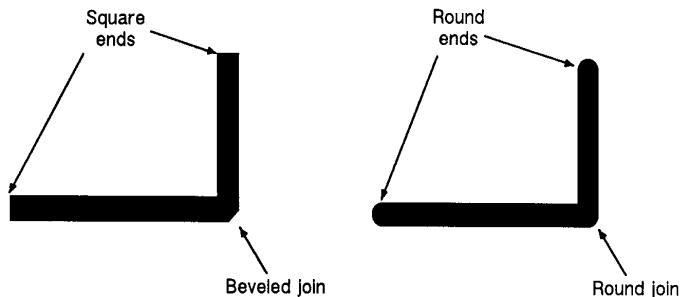

Figure 22-1 Line Ends Attribute

Line types are repeated patterns of dots and/or dashes (including solid lines). The following shows some examples of line types. Note that you can also vary the width of the lines and line types you draw by using the Pen Width (PW) command.

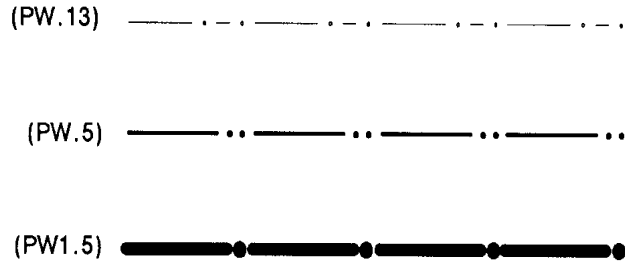

Figure 22-2 Line Types Attribute

Once you specify a line type and line attributes, all lines created by the following commands are drawn using the new line type and attributes. Line types and their interactions with fill patterns are discussed later in this chapter.

Table 22-2 Commands Affected by Line Types

Command	Group
AA, Arc Absolute	<i>The Vector Group</i>
AR, Arc Relative	
AT, Absolute Arc Three Point	
BR,.Bezier Relative	
BZ,.Bezier Absolute	
PA, Plot Absolute	
PD, Pen Down	
PE, Polyline Encoded	
PR, Plot Relative	
RT, Relative Arc Three Point	
CI, Circle	<i>The Polygon Group</i>
EA, Edge Rectangle Absolute	
EP, Edge Polygon	
ER, Edge Rectangle Relative	

Table 22-2 Commands Affected by Line Types (continued)

EW, Edge Wedge	
FP, Fill Polygon	
RA, Fill Rectangle Absolute	
RR, Fill Rectangle Relative	
WG, Fill Wedge	

Using Fill Types

Using the Fill Type (FT) command adds detail to your drawings and increases their visual effectiveness. The fill type affects the RA (Fill Rectangle Absolute), RR (Fill Rectangle Relative), WG (Fill Wedge), FP (Fill Polygon) commands, and CF (Character Fill) commands. PCL 5 printers support **solid**, **parallel line**, (hatching), **HP-GL/2 cross-hatch**, **raster fill** (shading is a special type of raster fill), and **PCL cross hatch** and **PCL user-defined** fills. Figure 22-3 shows the first four types. The **user-defined** fill type shown on the right can be printed using the HP-GL/2 RF (raster fill) command. User-defined fills can also be selected with the FT (Fill Type) command after having been created in PCL context (see “User-Defined Raster Graphics” in Chapter 13).

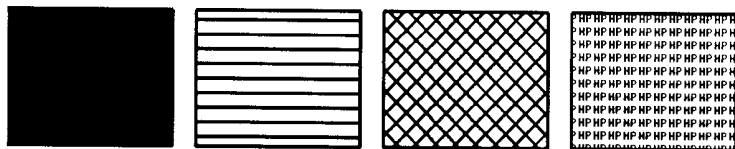

Figure 22-3 Fill Types

When you use HP-GL/2 hatching or cross-hatch fill types, the lines are drawn using the currently selected line width, type, and attributes. For example, if you have selected a dashed line type and a hatched fill type, your figure is filled with dashed, parallel lines. All fill types have an *anchor corner*, the starting point of the fill pattern. Its default location is in the lower-left corner of the PCL Picture Frame. Conceptually, the fill type replicates out from the anchor corner in the plus X-directions and plus Y-directions, as shown in the following illustration. Figures are filled by that portion of the fill type resident to the area (refer to rectangles 1 and 2).

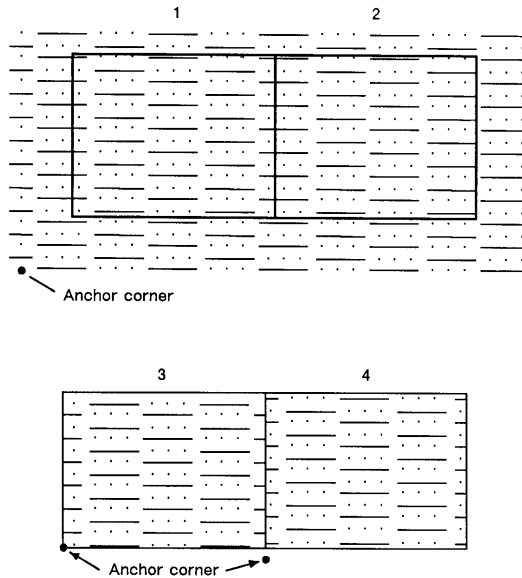

Figure 22-4 Fill Area Anchor Corner

Use the AC (Anchor Corner) command to position the fill type in relation to the figure. Rectangle 3 has an anchor corner set in its the lower-left corner. Rectangle 4 has an anchor corner set below the lower-left corner to alter the pattern's position and give contrast to the adjacent figure.

Selecting a “Pen” and Changing Line Width

Even though the printer does not print with a physical pen as a plotter does, the printer uses a “logical pen” which emulates the action of a physical pen. You must use the SP1 (Select Pen) command to draw black lines on the paper.

You can change the width of the logical pen using the Pen Width (PW) command. Subsequent lines are drawn using the new width. Use PW to vary line thicknesses and enhance your plots. You may change widths as often as you like, without sending an SP command again.

Pen (line) widths can be specified either in millimeters or as a percentage of the diagonal distance from P1 to P2. Use the WU (Pen Width Unit Selection) command to select how the pen width is specified. Since using the WU command defaults the width of both pens (black and white), send WU *before* a PW command.

AC, Anchor Corner

This command positions the starting point of any fill pattern. Use AC to ensure that the selected fill pattern is positioned as expected within the figure.

AC X,Y[:]

or

AC [:]

Parameter	Format	Functional Range	Default
X,Y coordinates	current units	-2^{30} to $2^{30} - 1$	no default

The 'anchor corner' is the point at which any fill pattern starts. Setting the anchor corner guarantees that a corner point of the selected fill pattern is at the specified coordinate, aligned vertically and horizontally.

- **No Parameters** — Defaults the anchor corner to the lower-left corner of the PCL Picture Frame (relative to the current coordinate system). Equivalent to (AC0,0).
- **X,Y Coordinates** — The coordinate position defines the position of the starting point for any fill pattern.

The following example prints three adjacent squares with fill patterns anchored at the lower-left corner of the PCL Picture Frame. The fill pattern is continuous across each of the squares. In the set of squares below that, each square has an anchor corner set in its own lower-left corner. Notice how this helps distinguish between the adjacent figures.

Table 22-3 Example: Changing the Anchor Corner

?E	Reset the printer.
?%0B	Enter HP-GL/2 mode.
IN;	Initialize HP-GL/2 mode.

Table 22-3 Example: Changing the Anchor Corner (continued)

SP1;	Select pen number 1. The SP command must be used to enable printing.
PA3000,3000;	Specify absolute plotting and move to location (3000,3000).
FT3,400,45; RR1000,1000; ER1000,1000;	Specify fill type number 3 (parallel lines), with each line 400 plu apart and set at a 45° angle; fill a rectangle using the current pen location as the lower left corner, and a point 1000 plu to the right and 1000 plu up as the upper right corner; edge the outline of the rectangle just filled.
PR1000,0; FT4,400,45; RR1000,1000; ER1000,1000;	Move 1000 plu to the right; select fill type number 4 (cross-hatch); create a rectangle the same size as the first one, fill it with cross-hatch, and edge its outline.
PR1000,0; FT3,400,45; RR1000,1000; ER1000,1000;	Move to the right another 1000 plu and create another rectangle of the same size, this time filled with pattern number 3 again.
PA3000,1500; AC3000,1500; RR1000,1000; ER1000,1000;	Move to absolute location (3000,1500); move the anchor corner to location (3000,1500); fill a rectangle with the same dimensions as the previous three rectangles and edge its outline.
PA4000,1500; AC4000,1500; FT4,400,45; RR1000,1000; ER1000,1000;	Move to location (4000,1500) and specify the location as the anchor corner; select fill type number 4 (cross-hatch); fill and edge another rectangle.
PA5000,1500; AC5000,1500; FT3,400,45; RR1000,1000; ER1000,1000;	Move to absolute location (5000,1500) and specify that location as the anchor corner; select fill type number 3; fill and edge another rectangle.
?%0A	Enter the PCL mode.
?E	Send a reset to end the job and eject the page.

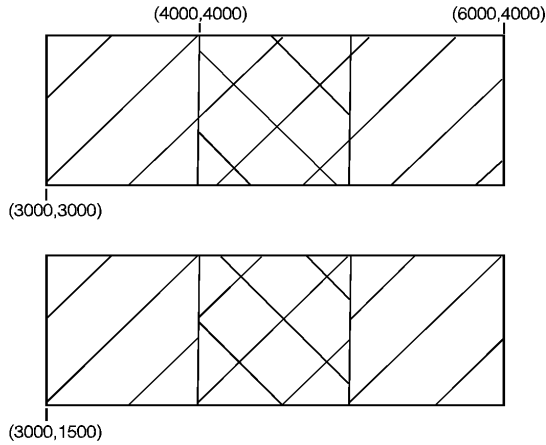

Figure 22-5

Table 22-4

Related Commands	Group
FT, Fill Type RF, Raster Fill Definition SV, Screened Vectors	<i>The Line and Fill Attributes Group</i>
FP, Fill Polygon RA, Fill Rectangle Absolute RR, Fill Rectangle Relative WG, Fill Wedge	<i>The Polygon Group</i>

FT, Fill Type

This command selects the shading pattern used to fill polygons (FP), rectangles (RA or RR), wedges (WG), or characters (CF). Use FT to enhance drawings using solid fill, shaded fill, parallel lines (hatching), cross-hatch, patterned (raster) fill, or PCL user-defined patterns.

FT *fill type*[,option1[,option2;]]

or

FT [:]

Parameter	Format	Functional Range	Default
fill type	clamped integer	1—4, 10, 11, 21, 22	1
option1, option2	clamped real	type dependent*	type dependent*

*Refer to the table following the parameter descriptions.

There are eight forms of fill types as shown above. The type parameter tells the printer which form you are using. If the fill type is specified, but the option1 and/or option2 parameter is omitted, values previously given for the specified fill type are assumed, or the defaults are assumed if none have been specified.

- **No Parameters** — Defaults all FT parameters and sets the fill type to solid fill. Equivalent to (FT1).
- **Type** — Selects the fill pattern. The table below lists the parameter values and corresponding fill types.
- **Option1, Option2** — The definition of these optional parameters depends on the type of fill selected. The following table lists the options available for each fill type.

Table 22-5

Fill Type	Description	Option1	Option2
1 and 2	solid black	ignored	ignored
3	hatching (parallel lines)	spacing of lines	angle of lines

Table 22-5 (continued)

4	cross-hatch	spacing of lines	angle of lines
10	shading	shading level	ignored
11	HP-GL/2 user-defined	raster-fill index	ignored
21	PCL cross-hatch patterns	pattern type	ignored
22	PCL user-defined	pattern ID	ignored

For fill types 3 and 4, the *option1* parameter specifies the distance between the lines in the fill. This distance is specified in current units measured along the X-axis. Option1 must be a positive number (if zero, then 1% of the diagonal distance from P1 to P2 is used). The default spacing is 1% of the diagonal distance from P1 to P2. Subsequent changes in the P1/P2 locations affect this distance only if the spacing is defined in user-units (an SC command is in effect).

For fill types 3 and 4, the *option2* parameter specifies an angle, in degrees, for the lines of the fill. This angle is a positive angle referenced from the positive plotter-unit X-axis, as shown in the following illustration (0 and 180 are horizontal; 90 and 270 are vertical). The first set of lines for cross-hatched fill are drawn at the specified angle and the next set are drawn at that angle plus 90 degrees.

Note

A positive angle is an angle rotated from the +X-axis to the +Y-axis as shown below. A negative angle of rotation is in the direction of the +X-axis to the -Y-axis.

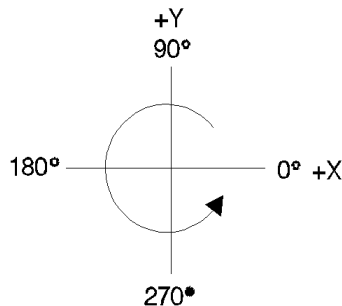

Figure 22-6 Positive Angle of Rotation

Note

The relationship of the +X-axis to the +Y-axis (and the -Y-axis) can be changed as a result of scaling point or scaling factor changes, thus changing the direction of a positive (and negative) angle of rotation.

Types 3 and 4 use the current pen and line type defined by the Line Type, Pen Width, and Line Attribute commands.

If the spacing between lines is defined in plotter units (no Scale command used), turning scaling on or changing the locations of P1 and P2 has no affect on the spacing. If, however, the spacing is defined in user-units, the spacing fluctuates with changes in the location of P1 and P2 (the X_{\min}, Y_{\min} and X_{\max}, Y_{\max} points if scaling is isotropic) or subsequent scaling command changes. Turning off scaling causes the spacing to be frozen in the plotter-unit equivalent of the current user-unit value. If the spacing is a percentage of the diagonal distance from P1 to P2, the percentage is maintained and spacing fluctuates with changes to P1 and P2 (the X_{\min}, Y_{\min} and X_{\max}, Y_{\max} points if scaling is isotropic).

Note

The end points of HP-GL/2 hatching fills are drawn with the current line cap. Lines are not clipped to the polygon.

For fill type 10, the option1 parameter specifies the level of shading. The level is specified as a percentage from 0 to 100. The following illustration shows the available shading patterns.

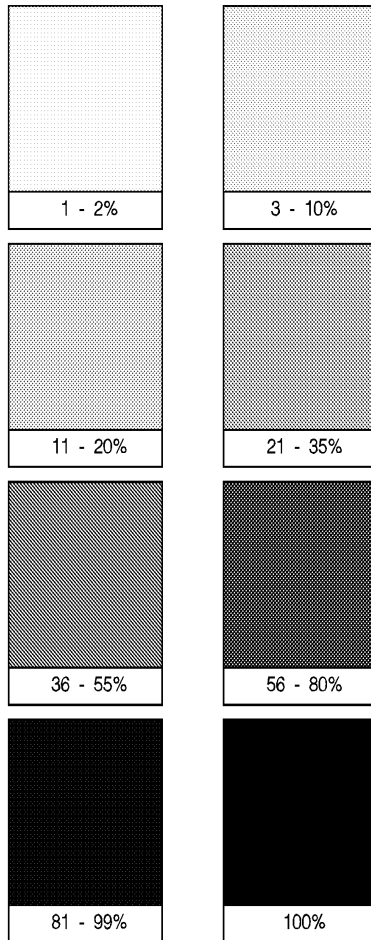

Figure 22-7 HP-Defined Shading Patterns

For fill type 11, the option1 parameter selects the corresponding HP-GL/2 user-defined raster fill using the index number specified in the RF command. Refer to the Raster Fill Definition (RF) command for more information about creating user-defined fill types. If you have not issued an RF command, the printer uses solid fill.



Figure 22-8 HP-GL/2 User-Defined Pattern

For fill type 21, the option1 parameter selects one of the six predefined PCL cross-hatch patterns using a value between 1 and 6. The following illustration shows the six different PCL cross-hatch patterns, and their corresponding parameter numbers.

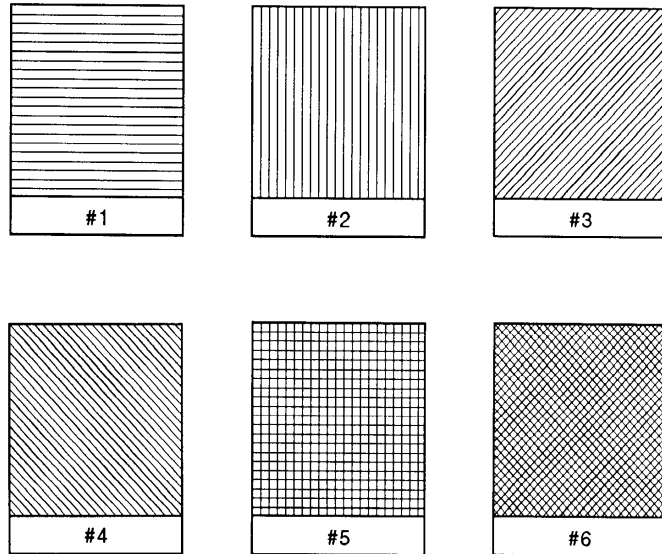

Figure 22-9 PCL Cross-Hatch Patterns

For fill type 22, the optional parameter selects the corresponding PCL user-defined pattern specified by way of the `?*c#W` command. Option1 specifies the pattern associated with the user-defined fill pattern. Option2 is ignored if present. See “User-Defined Pattern Graphics” in Chapter 13 for a discussion of PCL user-defined patterns.

Table 22-6 Example: Using the FT Command

?E	Reset the printer.
?%0B	Enter HP-GL/2 mode.
IN;	Initialize HP-GL/2 mode.
SP1;	Select pen number 1. Even though there is no physical pen, the SP command must be used to enable printing.

Table 22-6 Example: Using the FT Command (continued)

PA2000,2000;	Specify absolute plotting and move to location (2000,2000).
FT;RR2500,300; ER2500,300;	Select the default fill type (solid black); fill a rectangle using solid black fill, with the lower left corner being the current pen location and the upper right corner a point 2500 plu to the right and 300 plu up; edge the rectangle that was just filled.
PR0,300;FT3,80,30 ; RR2500,300;	Specify relative plotting and move the pen up 300 plu; select fill type number 3 (parallel lines), with 80 plu between each line, with each line tipped 30x; fill a rectangle with the just-specified fill, using the rectangle bounded at the lower left corner by current the pen location and a point 2500 X-units and 300 Y-units away as the upper right corner.
PR0,300;FT10,36; RR2500,300; ER2500,300;	Move the pen position up 300 plu; specify the fill type as 36% shading; fill a rectangle with 36% shading, with the lower left corner being the current pen location and the upper right corner 2500 plu to the right and 300 plu up from there; edge the outline of the same rectangle.
?%0A	Enter the PCL mode.
?E	Send a reset to end the job and eject the page.

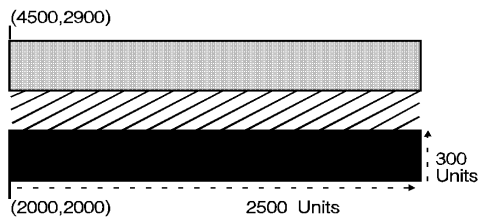

Figure 22-10

Table 22-7

Related Commands	Group
LA, Line Attributes LT, Line Type PW, Pen Width RF, Raster Fill Definition	<i>The Line and Fill Attributes Group</i>
FP, Fill Polygon RA, Fill Rectangle Absolute RR, Fill Rectangle Relative WG, Fill Wedge	<i>The Polygon Group</i>
CF, Character Fill Mode	<i>The Character Group</i>
SV, Screened Vectors	<i>The Line and Fill Attributes Group</i>

LA, Line Attributes

Specifies how line ends and line joins are physically shaped. Use this command when drawing lines thicker than 0.35 mm.

LA *kind,value[,kind,value[,kind,value;]]*

or

LA *[:]*

Parameter	Format	Functional Range	Default
kind	clamped integer	1 through 3	1
value	clamped integer	Kind 1: 1 - 4	1 (Butt)
	clamped integer	Kind 2: 1 - 6	1 (Mitered)
	clamped real	Kind 3: 1 to 32,767	5

There are three line attributes: *line ends*, *line joins*, and the *miter limit*. The LA command parameters are used in pairs: the first parameter, *kind*, selects a line attribute, and the second parameter, *value*, defines the appearance of that attribute. The printer uses the current line attributes when the optional parameter pairs are omitted.

- **No Parameters** — Defaults the line attributes to butt ends, mitered joins, and a miter limit of 5. Equivalent to (LA1,1,2,1,3,5).
- **Kind**— Specifies the line attribute for which you are setting a value. Attributes and kind parameter values are listed in the following table.
- **Value**— Defines the characteristics of the attribute specified by the kind parameter. The available values are listed in the following table and described under each attribute.

Table 22-8

Attribute	Kind	Value	Description
Line Ends*	1	1	Butt (default)
		2	Square
		3	Triangular
		4	Round
Line Joins*	2	1	Mitered (default)
		2	Mitered/beveled
		3	Triangular
		4	Round
		5	Beveled
		6	No join applied
Miter Limit	3	**	5 (default, refer to description under <i>Miter Limit</i>)

* Lines with a width of 0.35 mm or less always have butt caps and no join, regardless of the current attribute setting.

** Full range is 1 to 32,767, but values less than 1 are automatically set to 1.

Note

Labels are always drawn with rounded ends and joins.

Line Ends

The value you specify for line ends determines how the ends of line segments are shaped. The following illustration describes the four types of line ends.

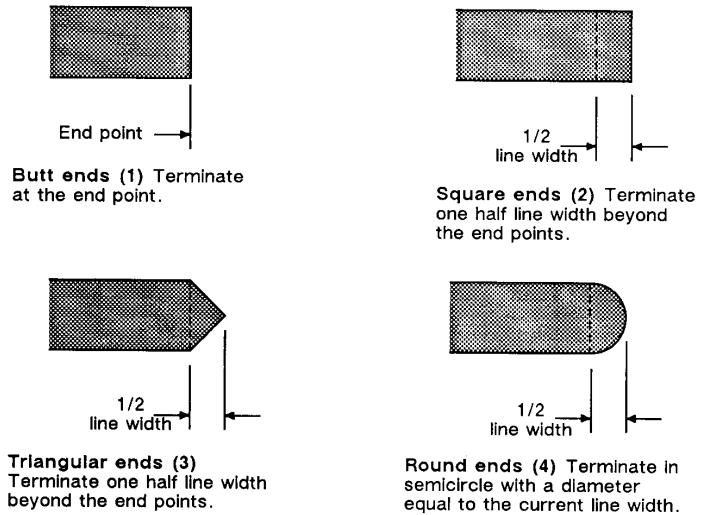

Figure 22-11 Four Line Ends

Line Joins

The value you specify for the line joins attribute determines how connecting line ends (corners) are shaped. The following illustration describes the five types of line joins. If the first and last points of a series of lines are the same, they join according to the current line join and miter limit.

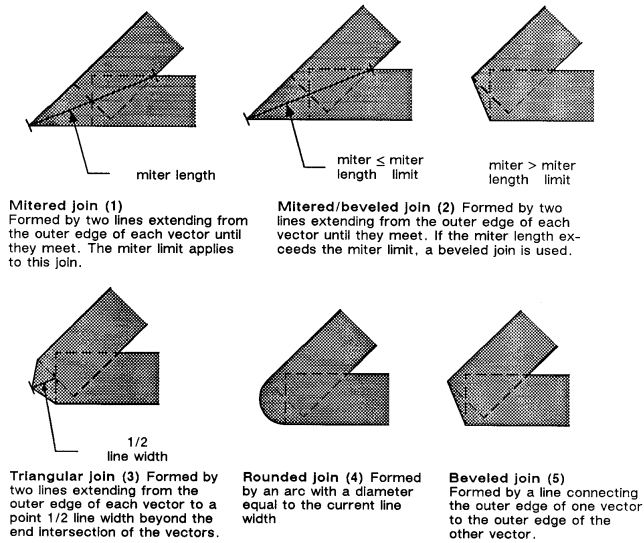

Figure 22-12 Five Line Joins

When you select 'no join' (LA2,6;), the currently selected line ends for the two lines merely overlap. Refer to the following illustration.

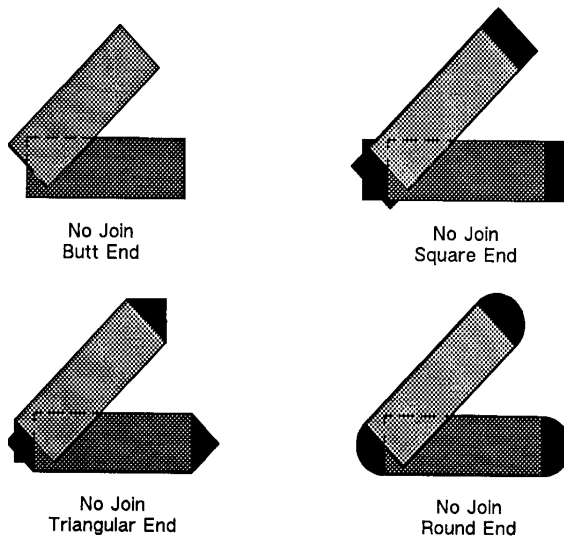

Figure 22-13 Overlapping Line Ends without Line Join Selection

Miter Limit

The value you specify for miter limit determines the maximum 'length' of a mitered join, as shown in the following illustration. The miter limit is the ratio of the miter length (the length of the diagonal line through the join of two connecting lines), to the line width. For example, with the default miter limit of 5, the miter length can be as long as 5 times the line width.

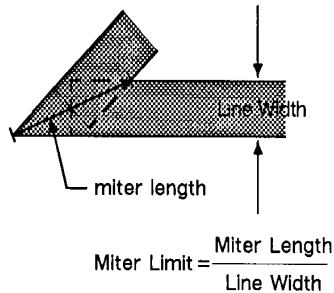

Figure 22-14 Miter Limit

When the miter length exceeds the miter limit, the point of the miter is clipped to the miter limit (the clipped miter is equivalent to a beveled join). The default miter limit is usually sufficient to prevent clipping except at very narrow join angles.

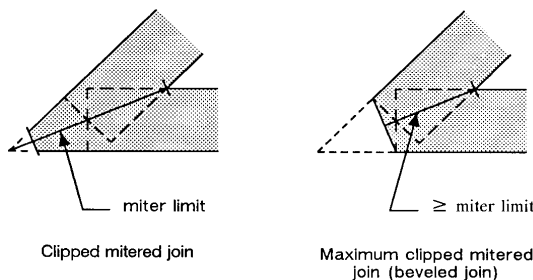

Figure 22-15 Miter Limit Clipping

An LA command remains in effect until another LA command is executed, or the printer is initialized or set to default conditions.

The following example draws an electrical ground symbol using the LA command.

Table 22-9 Example: Using the LA Command

?E	Reset the printer.
?%0B	Enter HP-GL/2 mode.
IN;	Initialize HP-GL/2 mode.
SP1;	Select pen number 1. Even though there is no physical pen, the SP command must be used to enable printing.
PA4000,3000;	Specify absolute plotting and move the pen to (4000,3000).
PW2;LA1,3; PD3500,2500, 4000,2000;	Set the pen width to 2 mm; specify a triangular line end, place the pen down, and draw from the current location to (3500,2500), then to (4000,2000).
PU3500,2500; LA2,2,3,20; PD3000,2500, 3000,2300;	Lift the pen and move to (3500,2500); set the line join to mitered/beveled and the miter limit to 20; set the pen down and draw a line to (3000,2500), then to (3000,2300).
PU2500,2300; LA1,4; PD3500,2300;	Lift the pen and move it to (2500,2300); specify round line ends and draw a line to (3500,2300).
PU2700,2100; PD3300,2100;	Lift the pen and move to (2700,2100), then set the pen down and draw a line to (3300,2100).
PU2900,1900; PD3100,1900;	Lift the pen and move to (2900,1900), then draw a line to (3100,1900).
?%0A	Enter the PCL mode.
?E	Send a reset to end the job and eject the page.

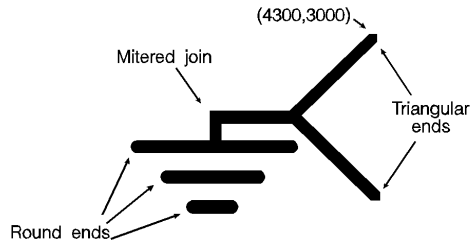

Figure 22-16

Table 22-10

Related Commands	Group
FT, Fill Type LT, Line Type PW, Pen Width UL, User-Defined Line Type	<i>The Line and Fill Attributes Group</i>
AA, Arc Absolute AR, Arc Relative AT, Absolute Arc Three Point BR, Bezier Relative BZ, Bezier Absolute CI, Circle RT, Relative Arc Three Point	<i>The Vector Group</i>
EA, Edge Rectangle Absolute EP, Edge Polygon ER, Edge Rectangle Relative EW, Edge Wedge FP, Fill Polygon RA, Fill Rectangle Absolute RR, Fill Rectangle Relative WG, Fill Wedge	<i>The Polygon Group</i>

LT, Line Type

This command specifies the line pattern to be used when drawing lines. Use LT to vary lines and enhance your plot. Note that the ends of dashed line segments in a line pattern are affected by current line attributes (refer to the LA command earlier in this chapter).

LT *line type* [, *pattern length* [, *mode* ;]]

or

LT [:]

or

LT99 [:]

Parameter	Format	Functional Range	Default
line type	clamped integer	-8 to 8	solid line
		99	restores previous line type
pattern length	clamped real	>0	4% of the distance between P1 and P2
mode	clamped integer	0 or 1	0 (relative)

The LT command applies to lines drawn by the AA, AR, AT, CI, EA, EP, ER, EW, FP, PA, PD, PE, PR, RA, RR, RT, and WG commands. Line types are drawn using the current line attributes set by the Line Attribute (LA) command. For example, if you have used LA to specify rounded ends, the printer draws each dash in a dashed line pattern with rounded ends.

- **No Parameters**- Defaults the line type to solid and saves the previous line type, pattern length, and any unused portion of the pattern (residue).
- **Line Type**- Subsequent lines are drawn with the corresponding line pattern. Line patterns can be of fixed or adaptive type.

- **Positive line types (1 - 8)** are fixed line types and use the specified pattern length to draw lines. Any unused part of the pattern (the residue) is carried over into the next line. The residue is saved when any of the following commands are received: CI, EA, EP, ER, EW, FP, PM, RA, RR, or WG. The residue is restored when the current pen position is restored upon completion of these HP-GL/2 commands.
- The following commands clear current residue and vector end points:

Table 22-11 Commands that Affect LT1 - LT8

Command	Group
AC,Anchor Corner	<i>The Line and Fill</i>
LA,Line Attributes	<i>Attributes Group</i>
LT,Line Type (except (LT) and (LT99))	
PW,Pen Width	
RF,Raster Fill Definition	
SP>Select Pen	
TR,Transparency Mode	
UL,User-Defined Line Type	
WU,Pen Width Unit Selection	
DF,Default Values	<i>The Configuration and Status Group</i>
IN,Initialize	
IP,Input P1 and P2	
IR,Input Relative P1 and P2	
IW,Input Window	
RO,Rotate Coordinate System	
SC,Scale	

A zero line type (0) draws only a dot at the X,Y coordinates for AA, AR, AT, CI, PA, PD, PR, and RT commands. Zero pen down values and zero length lines also produce dots. A dot is a one plotter unit long vector, drawn using the current line end and pen width. (Dots within lines are drawn at the correct angle, but zero length vectors are drawn along the user's current X-axis.)

Negative line types (-1 - -8) are adaptive line types. The pattern length is automatically adjusted so that each line contains one or more complete patterns.

Line patterns are composed of alternate pen down and pen up moves which are percentages of the pattern length (the first percentage is always pen down).

99 (LT99) restores the previous line type (and residue if it is a fixed-line type).

Note

If a solid line type is selected (LT;) when the LT99 command is issued, and the current pen position has not changed, the previously selected line type can be invoked using LT99. LT99 is ignored when a non-solid line type is in effect, or if the pen is in a different position than when the previous non-solid line ended. An example using this command is to print a line in a non-solid line type, followed by a rectangle in solid black; beginning at the end point of the previous line, use LT99 to print another line in the previous non-solid line type.

Sending any of the following commands while plotting with a solid line type clears the previous line type and a subsequent (LT99) has no effect:

Table 22-12 Commands that Affect LT99

Command	Group
AC,Anchor Corner	<i>The Line and Fill</i>
LA,Line Attributes	<i>Attributes Group</i>
LT,Line Type (except (LT) and (LT99))	
PW,Pen Width	
RF,Raster Fill Definition	

Table 22-12 Commands that Affect LT99 (continued)

SP,Select Pen TR,Transparency Mode UL,User-Defined Line Type WU,Pen Width Unit Selection	
DF,Default Values IN,Initialize IP,Input P1 and P2 IR,Input Relative P1 and P2 IW,Input Window RO,Rotate Coordinate System SC,Scale	<i>The Configuration and Status Group</i>

Figure 22-17 first shows the line type patterns, then gives the pattern percentages.

Note

Do not use an adaptive line type when drawing circles, arcs, wedges, or polygons. The printer attempts to draw the complete pattern in every chord (there are 72 chords in a circle using the default chord angle).

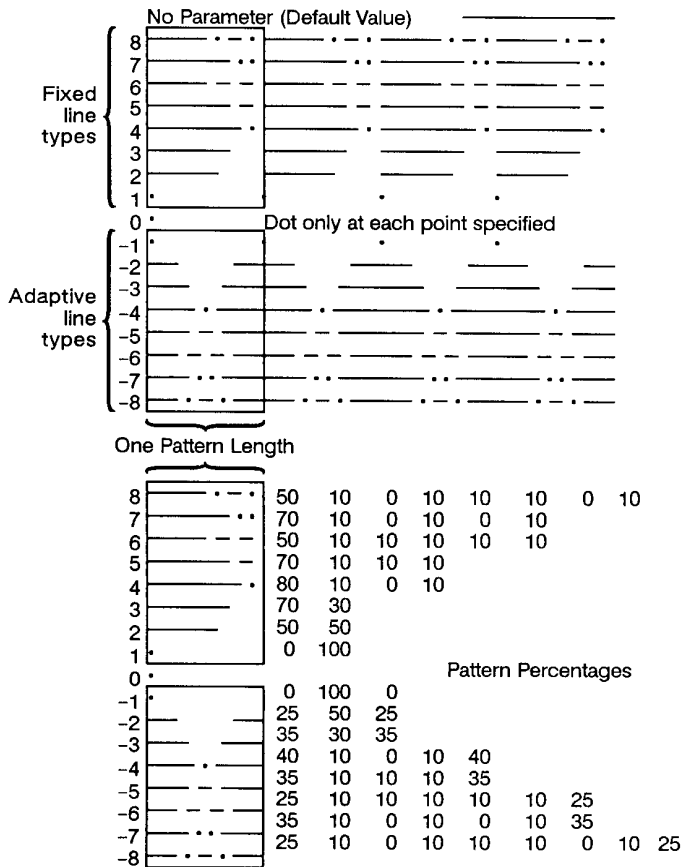

Figure 22-17 Line Type Patterns and Pattern Percentages

- **Pattern Length**- Specifies the length of one complete line pattern, either as a percentage of the diagonal distance between the scaling points P1 and P2 or in millimeters (see *mode* below). You must specify a length greater than zero or the printer ignores the command. If you do not specify a length, the printer uses the last value specified.
- **Mode**- Specifies how the values of the pattern length parameter are interpreted. If you do not specify a mode, the printer uses the last value specified. Values other than 0 or 1 invalidate the command.
- **0 - Relative mode**. Interprets the pattern length parameter as a percentage of the diagonal distance between P1 and P2.
- When specified as a percentage, the pattern length changes along with changes in P1 and P2.

- **1 - Absolute mode.** Interprets the pattern length parameter in millimeters.
- When specified in millimeters, fixed line-type patterns assume the specified length, but adaptive line-type pattern lengths are adjusted to fit an integral number of patterns per vector. (This is true for relative mode and absolute mode.)

If you do not specify the pattern length and mode parameters, then the printer uses their current values. When using relative mode and isotropic scaling, the pattern length changes with changes to X_{min} , Y_{min} and X_{max} , Y_{max} .

An LT command remains in effect until another LT command is executed or the printer is initialized or set to default conditions.

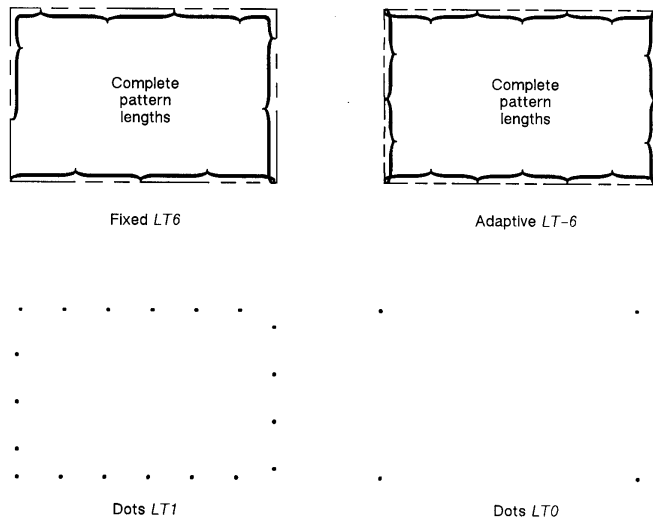

Figure 22-18 Fixed and Adaptive Line Types

Table 22-13

Related Commands	Group
FT, Fill Type	<i>The Line and Fill</i>
PW, Pen Width	<i>Attributes Group</i>
UL, User-Defined Line Type	

Table 22-13

AA,Arc Absolute AR,Arc Relative AT,Absolute Arc Three Point CI,Circle PA,Plot Absolute PD,Pen Down PE,Polyline Encoded PR,Plot Relative RT,Relative Arc Three Point	<i>The Vector Group</i>
EA,Edge Rectangle Absolute EP,Edge Polygon ER,Edge Rectangle Relative EW,Edge Wedge FP,Fill Polygon RA,Fill Rectangle Absolute RR,Fill Rectangle Relative WG,Fill Wedge	<i>The Polygon Group</i>

PW, Pen Width

This command specifies a new width for the logical pen. Subsequent lines are drawn in this new width. Use PW to vary your lines and enhance your drawings. Pen width can be specified as a fixed value or relative to the distance between P1 and P2. The pen width units are selected via the WU command (the default is metric-millimeters).

PW *width[,pen;]*

or

PW *[:]*

Parameter	Format	Functional Range	Default
width	clamped real	-32768 to 32767	Dependent ¹
pen	integer	0 or 1	1 (Black)

1. Dependent on the mode set by the Pen Width Unit Selection (WU) command: if mode is metric, default width is 0.35 mm; if mode is relative, default width is 0.1% of the diagonal distance from P1 to P2.

You may change the pen width as often as you like, without sending another SP command. If the pen is down when you change the width, the new width takes effect at the next line. *If you use WU to change the type of units used for the width parameter (metric or relative), send the WU command before PW.*

- **No Parameters-** Defaults the pen line width according to the current units set by WU: 0.35 mm if metric; .1% of the diagonal distance from P1 to P2 if relative.
- **Width-** Specifies the line width. When the parameter is zero, the printer assumes the thinnest line width (1 dot wide).
 - Metric widths are scaled by the ratio of the size of the PCL Picture Frame to the HP-GL/2 plot size. For example, if the HP-GL/2 plot size is twice as large as the PCL Picture Frame, "WU;PW.3;" sets the width of vectors to 0.15mm. (If the ratios are different for the X and Y axes, the smaller ratio is used. If the width is less than the thinnest available, then the thinnest width is used.)

- **Pen-** Specifies the pen number to which the new width applies. If the pen parameter is not specified, the printer applies the width to both pens. Specifying pen numbers other than 0 or 1 causes the printer to ignore the command.

Note

Pen width does not set the width of lines for drawing labels (unless the stroke weight value is set to 9999 [Stick/Arc fonts only]). The width of character lines is determined by the stroke weight attribute of the Alternate Font Definition (AD) or Standard Font Definition (SD) commands.

A PW command remains in effect until another PW command or a WU command is executed. PW is not defaulted by the Default Values (DF) command.

Table 22-14 Example: Using the PW Command

?E	Reset the printer.
?%0B	Enter HP-GL/2 mode.
IN;	Initialize HP-GL/2 mode.
SP1;	Select pen number 1. Even though there is no physical pen, the SP command must be used to enable printing.
PA3500,2500;	Specify absolute plotting and move the pen to (3500,2500).
PW1.5;PD4500,2800 , 4500,1800,3500, 1500,3500,2500;	Select a pen width of 1.5 mm. Set the pen down and draw a line from the current position to (4500,2800), then (4500,1800), next to (3500,1500), and then to (3500,2500).
PW.8;PD2300,2900, 2300,1900,3500, 1500;	Set the pen width to .8 mm. Place the pen down and print a line to (2300,2900), then to (2300,1900), and finally to (3500,1500).
PW.5;PU2300,2900; PD3300,3200,4500, 2800;	Set the pen width to .5 mm, lift the pen, and move to (2300,2900). Set the pen down and draw a line to (3300,3200) and then another line to (4500,2800).
PW.25;PU4500,1800; PD3500,2100;	Set the pen width to .25 mm, lift the pen, and move to (4500,1800). Set the pen down and print a line to (3500,2100).

Table 22-14 Example: Using the PW Command (continued)

?%0A	Enter the PCL mode.
?E	Send a reset to end the job and eject the page.

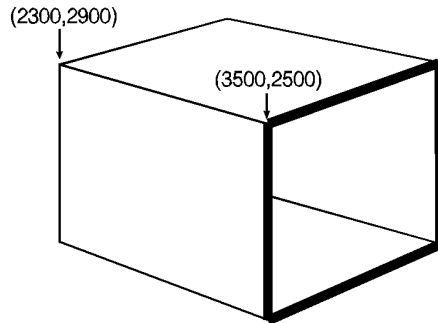

Figure 22-19

Table 22-15

Related Commands	Group
SP, Select Pen	<i>The Line and Fill Attributes Group</i>
SV, Screened Vectors	
WU, Pen Width Unit Selection	

RF, Raster Fill Definition

This command defines a rectangular pattern that may be used as area fill and for screened vectors (see the SV command). Use RF to create your own fill types and screen patterns.

RF *index,width,height,pen number[,...pen number;]*

or

RF *index[:]*

or

RF *[:]*

Parameter	Format	Functional Range	Default
index	clamped integer	1 to 8	1 (solid)
width	clamped integer	1 to 255	–
height	clamped integer	1 to 255	–
pen number	integer	0 or 1	–

The RF command does not *select* a fill type; use the Fill Type (FT) command with a type parameter of 11 and the corresponding raster fill index number for the second parameter (for example, [FT11,3] for an index number of 3).

- **No Parameters**- Defaults all raster fill patterns to solid fill.
- **Index**- Specifies the index number of the pattern being defined. Eight patterns can exist concurrently.
 - When you send RF with an index parameter only (RFn), the corresponding pattern is defaulted to solid fill.
- **Width, Height**- Specify the width and height (in pixels) of the pattern being defined.

Note

A pixel is equal to the size of one dot at the current printer resolution.

- **Pen Number** - Represents a pixel in the pattern being defined and indicates its color (black or white).

0 - White

>0 - Black

The pen number parameter defines pixels left to right, top to bottom. The total number of pen number parameters should be equal to the width times height parameters. For example, to define a pattern that is 8 x 16 pixels, you need 128 pen number parameters. If you do not include enough pen number parameters, the rest of the pixels are assumed to be white (zero). Patterns are printed in rows parallel to the plotter-unit X-axis.

Table 22-16 Example: Creating and Printing a Fill Pattern

?E	Reset the printer.
?%0B	Enter HP-GL/2 mode.
IN;	Initialize HP-GL/2 mode.
SP1;	Select pen number 1. Even though there is no physical pen, the SP command must be used to enable printing.
PU5,5;	Lift the pen and move to absolute position (5,5).
PA3500,2500;	Specify absolute plotting and move to (3500,2500).
RF2,8,4, 0,0,0,0,0,0,0,0, 0,0,0,1,1,0,0,0, 0,0,0,1,1,0,0,0, 0,0,0,0,0,0,0,0;	Define a raster fill pattern (index number 2) that is 8 dots wide by 4 dots high.
FT11,2;	Select the user-defined pattern having an index number of 2.

Table 22-16 Example: Creating and Printing a Fill Pattern

RR4000,800;EP;	Fill a rectangle with the fill pattern just specified, with a lower left corner of (3500,2500) and an upper right corner 4000 plu to the right and 800 plu up; edge the outline of the rectangle.
?%0A	Enter the PCL mode.
?E	Send a reset to end the job and eject the page.

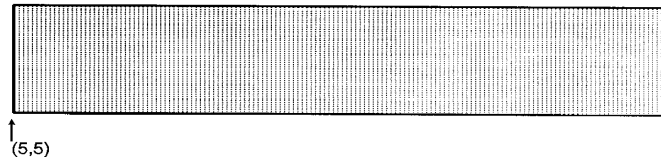

Figure 22-20

Table 22-17

Related Commands	Group
AC, Anchor Corner FT, Fill Type SV, Screened Vectors	<i>The Line and Fill Attributes Group</i>

SM, Symbol Mode

This command draws the specified symbol at each X,Y coordinate point using the PA, PD, PE, PR, and PU commands. Use SM to create scattergrams, indicate points on geometric drawings, and differentiate data points on multiline graphs.

SM *character*[:]

or

SM [:]

Parameter	Format	Functional Range	Default
character	label	most printing characters (decimal codes 33-58, 60-126, 161 and 254)*	—

*Decimal code 59 (the semicolon) is an HP-GL/2 terminator and cannot be used as a symbol in any symbol set. Use it only to cancel symbol mode (e.g., (SM;)).

The SM command draws the specified symbol at each X,Y coordinate point for subsequent PA, PD, PE, PR, and PU commands. The SM command includes an automatic pen down; after the symbol is drawn, the pen position and any dashed-line residue are restored.

- **No Parameter**—Terminates symbol mode.
- **Character**—Draws the specified character centered at each subsequent X,Y coordinate. The symbol is drawn in addition to the usual function of each HP-GL/2 command.
 - The character is drawn in the font selected at the time the vectors are drawn. If you change to a new symbol set, the character changes to the corresponding character from the new symbol set. The size (SI and SR), slant (SL), and direction (DI and DR) commands affect how the character is drawn. Specifying a non-printing character cancels symbol mode.

An SM command remains in effect until another SM command is executed or the printer is initialized or set to default conditions.

The following example shows several uses of symbol mode: with the pen down for a line graph, with the pen up for a scattergram, and with the pen down for geometric drawings.

Note

Symbol mode works only with the PA, PD, PE, PR, and PU commands. Notice that the circle and rectangle have symbols only for the PA command coordinate point.

Table 22-18 Example: Using the Symbol Mode Command

?E	Reset the printer.
?%0B	Enter HP-GL/2 mode.
IN;	Initialize HP-GL/2 mode.
SP1;	Select pen number 1. Even though there is no physical pen, the SP command must be used to enable printing.
SM*;PA200,1000; PD200,1230,400, 1560;	Enter symbol mode, using the asterisk (*) as the symbol; move to absolute location (200,1000), set the pen down, and draw first to (200,1230), then to (400,1560).
PD700,1670,1300, 1600,1800,2000; PU;	Place the pen down and draw from the current pen position (400,1560) to (700,1670), then to (1300,1600), then to (1800,2000); lift the pen.
SM3;PA700,500, 900,450,1300,850;	Enter symbol mode again with "3" as the current symbol; print a "3" in the following locations: (700,500), (900,450), and (1300,850).
PA1750,1300,2500, 1350;PU;SM;	With the pen still up and "3" still the current symbol, print a "3" at (1750,1300) and (2500,1350); lift the pen and exit symbol mode.
PA3300,1100;PD; SMY;PA4400,1890; SMZ;	Move to (3300,1100), set the pen down, and enter symbol mode with "Y" as the symbol; draw a line to (4400,1890) and print a "Y"; re-enter symbol mode with "Z" as the current symbol.

Table 22-18 Example: Using the Symbol Mode Command

PA4600,1590;SMX; PA3300,1100;PU;	Draw a line to (4600,1590) and print a “Z”; specify “X” as the next symbol, move to (3300,1100), and print an “X”; lift the pen.
SMA;PA4000,400; CI400;	Specify “A” as the new symbol and move to (4000,400); draw a circle with a radius of 400 plu and print an “A” in the center.
SM*;PA2600,700; EA1500,200;	Specify “*” as the new symbol and move to (2600,700); edge the outline of a rectangle and print an “*” at the starting point.
?%0A	Enter the PCL mode.
?E	Send a reset to end the job and eject the page.

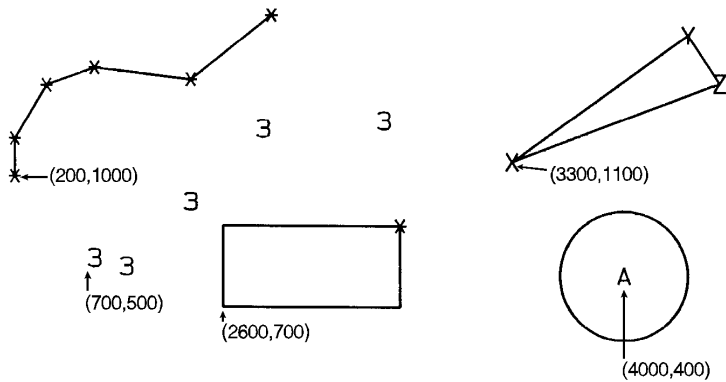

Figure 22-21

Table 22-19

Related Commands	Group
PA, Plot Absolute PD, Pen Down PE, Polyline Encoded PR, Plot Relative PU, Pen Up	<i>The Vector Group</i>

SP, Select Pen

This command selects the printer's 'logical' pen for subsequent plotting. An SP command must be included at the beginning of each command sequence to enable the printer to draw.

SP *pen number*[:]

or

SP [:]

Parameter	Format	Functional Range	Default
pen number	integer	0 or 1	No pen

Although your printer does not have physical pens, for the purpose of compatibility it has a 'logical' pen which you must select to print your drawing.

- **No Parameters**— Cancels pen selection; subsequent plotting commands are not drawn. Equivalent to (SP0).
- **Pen Number**— Selects the printer's 'logical' pen. The printer will not draw unless an SP is sent.
- **0** — Selects the white pen. To see a white pen on a non-white background you must set transparency mode to OFF (TR0;).
- **1** — Selects the black pen; numbers greater than 1 are also interpreted as 1.

Use the Pen Width (PW) command to change the line width. You may change widths as often as you like, without sending an SP command again.

Note

If you are not using the Transparency Mode (TR) command, white is always transparent. For more information on the Transparency Mode command, see the TR command description later in this chapter.

Table 22-20

Related Commands	Group
PW, Pen Width WU, Pen Width Unit Selection TR, Transparency Mode	<i>The Line and Fill Attributes Group</i>

SV, Screened Vectors

This command selects the type of screening (area fill) to be applied to vectors. Options include lines, hatching patterns (fill types 3 and 4), arcs, circles, edges of polygons, rectangles, wedges and PCL user-defined patterns. SV does not affect solid fill types, stroked characters, or edges of characters.

SV [*screen_type* [,*option1* [,*option2*]]];;

or

SV [;]

Parameter	Format	Functional Range	Default
screen_type	clamped integer	0, 1, 2, 21, 22	No screening (solid)
option1, option2	clamped integer	type dependent*	type dependent

* Refer to the table following the parameter descriptions.

There are four types of screen fill: shaded fill, HP-GL/2 user-defined raster fill, predefined PCL cross-hatch patterns, and PCL user-defined patterns.

- **No Parameters**— Defaults to no screening (solid fill--same as SV0;).

- **screen_type**— Selects the types of screening as follows:
 - **0**— No screening
 - **1**— Shaded fill
 - **2**— HP-GL/2 User-defined raster fill (RF command)
 - **21**— Predefined PCL cross-hatch patterns
 - **22**— PCL user-defined raster fill (RF command)
 - **Option1, Option2**— The definition of these optional parameters depends on the screen type selected. The following table lists the options available for each fill type.

Table 22-21

Screen/Type	Description	Option1	Option2
1	Shaded Fill	% Shading (0 to 100)	Ignored
2	HP-GL/2 User-defined Raster Fill	Pattern Index	0—Pen 1 1—Current Pen
21	PCL Cross-hatch	1 - 6	Ignored
22	PCL User-defined Pattern Fill	Pattern ID	Ignored

For Type 1, specify the shading percentage using a number from 0 to 100. For example, to print vectors that are shaded 15%, specify (SV1,15;).

For Type 2, option1 specifies the index number of the fill pattern created using the RF (Raster Fill Definition) command. Option2 specifies whether the pattern should be printed in the color of pen number 1 (option2 = 0 parameter) or the current pen (option2 = 1 parameter). The selected pen is applied to the 1's pixels in the raster pattern.

For Type 21, the option1 parameter selects one of the six predefined PCL cross-hatch patterns using a value between 1 and 6. Refer to the FT command for an illustration of the six different patterns and their corresponding parameter numbers.

For *Type 22*, the optional parameter selects the corresponding PCL user-defined pattern specified by way of the *?*c#W* command. Option1 specifies the pattern associated with the user-defined fill pattern. Option2 is ignored if present. See "User-Defined Pattern Graphics" in Chapter 13 for a discussion of PCL user-defined patterns.

All parameters are optional. If all parameters are omitted, screening is turned off (the vectors are solid).

If *screen_type* is present, but *option1* and/or *option2* are omitted, values previously specified for the specified *screen_type* are used. If none have been specified since the last power-on, IN, DF, or ?E Reset, the defaults are assumed.

All screening patterns use the current anchor corner (see the AC command description).

Table 22-22

Related Commands	Group
AC, Anchor Corner FT, Fill Type PW, Pen Width RF, Raster Fill Definition WU, Pen Width Unit Selection	<i>The Line and Fill Attributes Group</i>

Table 22-23 POSSIBLE ERROR CONDITIONS:

Condition	Printer Response
1 or more parameters	ignores parameter

TR, Transparency Mode

This command defines how the white areas of the source graphics image affect the destination graphics image.

TR [n][:]

or

TR [:]

Parameter	Format	Functional Range	Default
n	clamped integer	0 or 1	1 (on)

- **No Parameters**— Defaults to transparency mode = on (TR1;).
- **n**— Specifies whether transparency mode is on or off:
- **0**— Transparency mode = off.
- **1**— Transparency mode = on (default).

When transparency mode is on (default), the portion of a source image which is defined by white pixels does not affect the destination; whatever was already written to the page “shows through” the white areas in the new image.

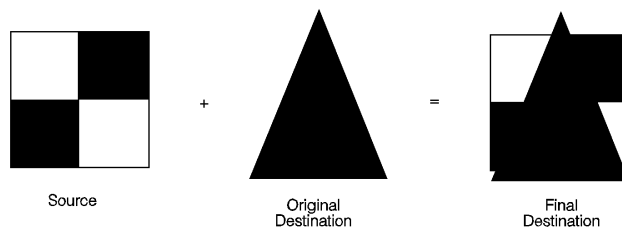

Figure 22-22 Transparency Mode = ON

When transparency mode is off, all source pixels are written to the destination, obscuring any underlying images.

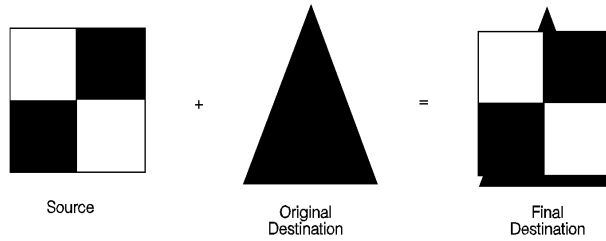

Figure 22-23 Transparency Mode = OFF

The transparency mode is defaulted by the ?E Reset, IN, or DF commands.

Note

For more information on the transparency mode, see the discussion of the “Source Transparency Mode” in Chapter 13, *The PCL Print Model*.

UL, User-Defined Line Type

This command creates line types by specifying gap patterns, which define the lengths of spaces and lines comprising a line type.

```
UL index [,gap1,...,gap20;
```

or

```
UL [;]
```

Parameter	Format	Functional Range	Default
index	clamped integer	1 through 8	—
gaps	clamped real	0 to 32767	default line types

The UL command allows you to define and store your own line types. The command does not itself select a line type. Use the LT command to select the line type once you have defined it with UL.

- **No Parameters** — Defaults all line types (refer to the LT command).
- **Index** — Identifies the number of the line type to be redefined. Specifying an index number without gap parameters sets the line type identified by the index to the default pattern for that number. The index number may not be 0.
 - The index parameter uses absolute values, so (UL-n) is the same as (ULn). Redefining a standard fixed line type automatically redefines the corresponding adaptive line type.
- **Gaps** — Specify alternate pen-down and pen-up stretches in the line type pattern; if gaps are numbered starting with 1, odd numbered gaps are pen-down moves, even numbered gaps are pen-up moves. The first gap is a pen-down move. Gap values are converted to percentages of the LT command's pattern length parameter.
 - A maximum of 20 gaps are allowed for each user-defined line type. Gap values must be non-negative; a gap value of zero produces a dot if specified for an odd numbered gap that is preceded or followed by a non-zero even-numbered gap. The sum of the gap parameters must be greater than zero.

The following example demonstrates redefining and printing a line type.

Table 22-24 Example: Using the UL Command

?E	Reset the printer.
?%0B	Enter HP-GL/2 mode.
IN;	Initialize HP-GL/2 mode.
SP1;	Select pen number 1. Even though there is no physical pen, the SP command must be used to enable printing.
PA4000,3000;	Specify absolute plotting and move to (4000,3000).
UL8,0,15,0,15,0,15,40,15;	Redefine the user-defined line type with an index number of 8; specify the lines and spaces as follows, in percentages of the line distance: gap1 as a dot (0%), gap2 as a space (15%), gap3 as another dot (0%), gap4 as a space (15%), gap5 as another dot (0%), gap6 as a space (15%), gap7 as a line (40%), and gap8 as a space (15%).
LT8,10;PU2000,2500;PD5000,2500;	Specify line type number 8 (just defined), with a pattern length of 10% of the distance between P1 and P2 (in this case, the lower-left and upper-right corners of the default PCL Picture Frame); lift the pen and move to (2000,2500); set the pen down and draw to (5000,2500).
?%0A	Enter the PCL mode.
?E	Send a reset to end the job and eject the page.

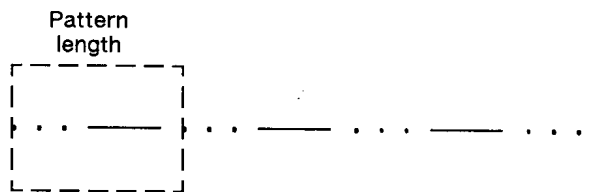

Figure 22-24

Table 22-25

Related Commands	Group
LA, Line Attributes LT, Line Type	<i>The Line and Fill Attributes Group</i>

Table 22-26 POSSIBLE ERROR CONDITIONS:

Condition	Printer Response
sum of gap parameters equals zero	ignores command
a gap is negative	ignores command
index = 0 or index > 8	ignores command

WU, Pen Width Unit Selection

This command specifies how the width parameter of the Pen Width (PW) command is interpreted (whether metric or relative units).

WU *type[:]*

or

WU *[:]*

Parameter	Format	Functional Range	Default
type	clamped integer	0 to 1	0 (metric)

Since using WU, with or without parameters, defaults all pen widths, send the WU command *before* a PW command (which sets a new pen width).

- **No Parameters** — Defaults type parameter to 0 (metric) and all pen widths to 0.35 mm.

- **Type** — Specifies how the width parameter of the Pen Width (PW) command is interpreted.
 - **0** — Metric. Interprets the pen width parameter in millimeters. Specifying type 0 defaults all pen widths to 0.35mm.
 - **1** — Relative. Interprets the pen width parameter as a percentage of the diagonal distance between P1 and P2. Specifying type 1 defaults all pen widths to 0.1% of the diagonal distance from P1 to P2.

If the specified type parameter is not 0 or 1, the printer ignores the command.

A WU command remains in effect until another WU command is executed, or the printer is initialized. WU is not defaulted by the Default Values (DF) command.

Table 22-27

Related Commands	Group
PW, Pen Width SP, Select Pen	<i>The Line and Fill Attributes Group</i>

23 The Character Group

Introduction

When you create an HP-GL/2 graphic and want to add text, you can either enter PCL mode to add text to your image or you can print text from within HP-GL/2 mode. If this is your first experience with HP-GL/2, you should know that the term “label” is used throughout this chapter to indicate the printing of text. This chapter discusses the various ways you can “label” your images using the printer’s vector graphics commands.

The information in this chapter enables you to perform the following:

- Position and print labels using any LaserJet font.
- Change label size, slant, and direction.
- Designate and select standard and alternate fonts.
- Print with proportional- and fixed-spaced fonts.
- Work with the character cell.

The following commands are described in this chapter:

Table 23-1 The Character Group Commands

Command	Summary
AD, Alternate Font Definition	Specifies an alternate font for labeling.
CF, Character Fill Mode	Specifies how outline fonts are rendered.
CP, Character Plot	Moves the pen the specified number of character cells from the current pen location.
DI, Absolute Direction	Specifies the slope of labels independent of P1 and P2 locations.

Table 23-1 The Character Group Commands (continued)

DR,Relative Direction	Specifies the slope of labels relative to P1 and P2 locations.
DT,Define Label Terminator	Defines the character or code that 'turns off' labeling.
DV,Define Variable Text Path	Specifies the label path as right, left, up, or down.
ES,Extra Space	Increases or reduces space between label characters and lines.
FI,Select Primary Font	Selects as standard a font previously assigned a PCL <i>font ID</i> number.
FN,Select Secondary Font	Selects as alternate a font previously assigned a PCL <i>font ID</i> number.
LB, Label	Prints text using the currently selected font.
LO, Label Origin	Positions labels relative to the current pen location.
SA, Select Alternate Font	Selects the font designated by AD for labeling.
SB, Scalable or Bitmap Fonts	Specifies the type of fonts to be used for labels.
SD, Standard Font Definition	Specifies the standard font for labeling.
SI, Absolute Character Size	Specifies an absolute character size (in centimeters).
SL, Character Slant	Specifies the slant at which labels are printed.
SR, Relative Character Size	Specifies the size of characters as a percentage of the P1/P2 distance.
SS, Select Standard Font	Selects the font designated by SD for labeling.

Table 23-1 The Character Group Commands (continued)

TD, Transparent Data	Specifies whether control characters perform their function or are printed as characters when printing text.
----------------------	--

Printing Labels

Use the Label command (LB) to create text charts or to emphasize areas of a diagram or graph that need special attention or explanation. You can control almost all aspects of the label's appearance: its position, size, slant, spacing, and direction. All labels are drawn using the font currently designated (refer to the SD or AD commands) and selected for use (refer to the SS or SA commands).

If you are using a font other than the default, use SD (Standard Font Definition) or AD (Alternate Font Definition) commands to designate a font that can be selected. Then, use the SS (Select Standard Font) or SA (Select Alternate Font) commands to select the designated font. You can follow the LB (Label) command with virtually any characters, including non-printing control codes, such as a Line Feed or Carriage Return.

Note

Symbol mode is a special case of a Label.

At the end of a label, you must use a special label terminator to signify the end of text. The default terminator is the ASCII end-of-text character ETX (decimal code 03), or you can define a terminator using the DT command. Without the label terminator in place, your printer continues to label your picture with all subsequent HP-GL/2 commands and parameters.

The following example demonstrates printing a simple label using the SD command to designate a font, the SS command to select that font, the DT command to define a label terminator, and the LB command to print the label, including Carriage Returns and Line Feeds.

Note

In the examples in this chapter, the left column identifies the command sequence data for the plot. If the label command text is too wide for the column width, is it continued on a second line (which might indicate a Carriage Return in the text). In actual use, the text should be presented on one line, with no carriage-returns. If a Carriage Return is required in the example, it is indicated as “*CR-LF*”

Table 23-2 Example: Printing Labels

<code>E_CE</code>	Reset the printer.
<code>E_C%0B</code>	Enter HP-GL/2 mode.
<code>IN;</code>	Initialize HP-GL/2 mode.
<code>SP1;</code>	Select pen number 1. Even though there is no physical pen, the SP command must be used to enable printing.
<code>PA1500,2500;</code>	Specify absolute plotting and move to (1500,2500).
<code>SD1,21,2,1,4,25,5,1,6,0,7,52;</code>	Designate the 25-point Univers Italic font as the standard font.
<code>DT*,1;</code>	Define the asterisk character as the label terminator (the 1 indicates the terminator shouldn't be printed).
<code>SA;</code>	Select the alternate font for printing. Since an alternate font hasn't been designated, the default 11.5-point Stick font is selected.
<code>LBThis is the Stick Font Default) CR-LF CR-LF *;</code>	Print the first line of text, followed by two Carriage Returns and two Line Feed control codes. Notice how the asterisk terminates the label.
<code>SS;</code>	Select the standard font.
<code>LBThis is Univers Italic*;</code>	Print the next line of text in the newly specified font.
<code>E_C%0A</code>	Enter the PCL mode.
<code>E_CE</code>	Send a reset to end the job and eject the page.

↑
 (1500,2500)
 This is the Stick Font (Default)
This is Univers Italic

Figure 23-1

Moving to the Carriage Return Point

When you begin labeling, the current pen location is the Carriage Return point (the beginning of your line of text is the point at which the pen is “returned” when a Carriage Return control code is sent to the printer). When the printer encounters a Character Plot (CP) command, or a Carriage Return control code within a Label command, the pen moves to the Carriage Return point, adjusted up or down by any line feeds. (The Character Plot command is described later in this chapter.)

The following commands update the Carriage Return point to the current pen location:

Table 23-3 Commands Updating Carriage Return Point to Current Location

Mnemonic	Command Name ¹
AA	Arc Absolute
AR	Arc Relative
AT	Absolute Arc (Three Point)
BZ	Bezier Absolute
BR	Bezier Relative
DF	Default Values
DI	Absolute Direction
DR	Relative Direction

Table 23-3 Commands Updating Carriage Return Point to Current Location (continued)

DV	Define Variable Text Path
IN	Initialize
LO	Label Origin
PA	Plot Absolute
PE	Polyline Encoded
PR	Plot Relative
RO	Rotate Coordinate System
RT	Relative Arc (Three Point)

1. A PD or PU command **with parameters** also updates the Carriage Return point. The CP command with a nonzero lines parameter updates the Carriage Return point's vertical location.

The Label (LB) command does not update the Carriage Return point to the current pen location, but continues labeling from the current pen location. This feature allows you to issue several label commands that write one long label and still use a Carriage Return to get to the beginning of the entire label.

Control Codes

You can effectively use the following control characters in labels. All other control codes are ignored.

Table 23-4 Commands Updating Carriage Return Point to Current Location

Control Code	DecimalCode
Backspace	8
Horizontal tab	9
Line feed	10
Carriage return	13
Shift Out ¹	14

Table 23-4 Commands Updating Carriage Return Point to Current Location (continued)

Shift In ²	15
Space	32

1. Equivalent to Select Alternate Font (SA) command.
2. Equivalent to Select Standard Font (SS) command.

Default Label Conditions

The following label default conditions are established when the printer is initialized, or set to default conditions. To change these settings, refer to the appropriate chapter or command.

- **Symbol Set (Character Set)** — Roman-8.
- **Font Spacing** — Fixed.
- **Pitch** — 9 characters per inch.
- **Height** — 11.5 point.
- **Posture** — Upright.
- **Stroke Weight** — Medium.
- **Typeface** — HP-GL/2 Stick.
- **Label terminator** — ASCII end-of-text character ETX (decimal code 3). Refer to the Define Label Terminator (DT) command.
- **Label starting point** — Current pen location (LO1). Refer to the Label Origin (LO) command.
- **Label direction** — Horizontal. Refer to the DI, DR, and DV commands.
- **Space between characters and lines** — Normal (no extra space). Refer to the Extra Space (ES) command.
- **Character Slant** — None (vertical). Refer to the Character Slant (SL) command.
- **Character Fill Mode** — Solid fill, no edging.

Enhancing Labels

You can enhance your labels by changing such aspects as the character size and slant, the space between characters and lines, and the orientation and/or placement of the label on the page. To effectively use these enhancements you should understand the properties of the character cell. Refer to “Working with the Character Cell” later in this chapter.

Character Size and Slant

You can change the size of the characters using the Absolute Character Size and the Relative Character Size (SI and SR) commands. The Absolute Character Size (SI) command establishes the nominal character width and CAP height in centimeters and maintains this character size independent of the location of P1 and P2 or the page size. The Relative Character Size (SR) establishes the nominal character width and CAP height as a percentage of the distance between P1 and P2. Subsequent changes in the location of P1 and P2 cause the character size to change with the SR command. Changing the character size changes the size of the CP (Character Plot) cell and proportionally changes the line width used in labels (refer to AD and SD).

Note

When the Shift In (SI) or Shift Out (SO) control codes are used to select a font, the font size reverts to that font specified using the AD or SD commands.

You can use the Character Slant (SL) command to slant the characters at a specified angle in either direction from the left vertical side of the CP (Character Plot) cell. The CP cell is not altered.

Character Spaces and Text Lines

You can use the Extra Space (ES) command to automatically increase or decrease spaces between all characters or lines. For example, ES can be used to increase space between every character in a label such as, M E M O R A N D U M), or to increase or decrease space between every line of text (such as double-spacing).

You can use the Character Plot (CP) command to move the pen a specific number of lines or spaces (character cells) from the current pen location. Use the CP command, for example, to indent a label a certain number of spaces.

Label Orientation and Placement

You can place your labels anywhere on the page in any orientation. The Absolute Direction (DI) command specifies the angle at which you want to print the characters, independent of the location of P1 and P2. The Relative Direction (DR) command specifies the angle at which you want to print the characters as a function of the P1 and P2 distance; thus when you change P1 and P2, the label angle changes to maintain the same orientation.

The DI and DR commands allow you to print text at any angle with the letters in their normal side-by-side orientation.

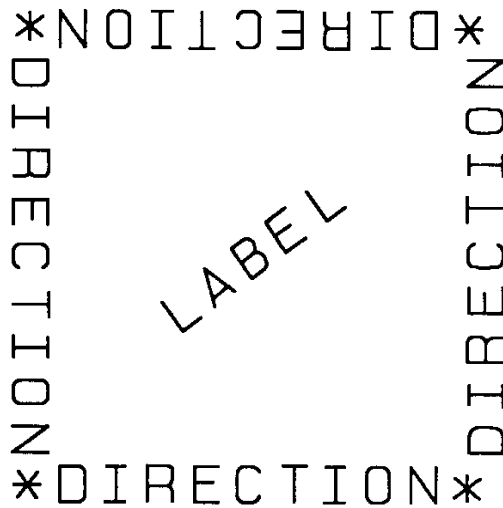

DIRECTION
DIRECTION
DIRECTION
DIRECTION

LABEL

Figure 23-2 Label Orientation and Direction

Note

Bit map characters are always printed orthogonally to the page (refer to Figure 23-17). Scalable characters print in the direction specified.

The Define Variable Text Path (DV) command allows you to specify the text path (right, left, up, or down) and the direction of Line Feeds with respect to the text path.

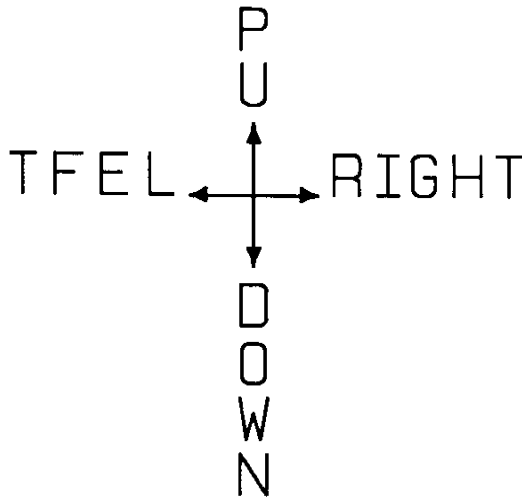

Figure 23-3 Define Variable Text Path Command

The Label Origin (LO) command simplifies placing labels on a drawing. Normally, the first character origin is the current pen location when the Label command is issued. The LO command allows you to specify that the label be centered and/or right- or left-justified from the current pen location. For example, the following illustration shows four centered lines of text.

Lines of any length
can easily be
centered
without cumbersome calculations.

Figure 23-4 Label Origin Command

These lines use one (X,Y) coordinate pair, one LO command to center labels, and a Carriage Return and Line Feed after each line. Without this command, an alternative method would involve calculating the length of the line in CP (Character Plot) cells, dividing by two, and using the CP command to 'Backspace' the required number of cells. The LO command saves calculation, decreases the number of characters sent to the printer, and allows you to take advantage of proportional fonts when the character widths are not known to the software.

Terminating Labels

LB tells the printer to print every character following the command, rather than interpreting the characters as graphics commands. In order to allow the normal terminator, the semicolon (;), to be used in text, the command is defined so that you must use the special 'print label terminator mode' to tell the printer to once again interpret characters as graphics commands. (If the command had been defined otherwise, you wouldn't be able to print semicolons in your text.)

The default label terminator is the non-printing ASCII end-of-text character ETX (decimal code 3). You must use the label terminator, or the printer prints the rest of your file as text instead of executing the commands. You can change the label terminator using the Define Label Terminator (DT) command.

Working with the Character Cell

In each font, the basis for each character or space is the character cell. Think of the character cell as a rectangular area around a character that includes blank areas above and to the right of the character. Refer to the Figure 23-5.

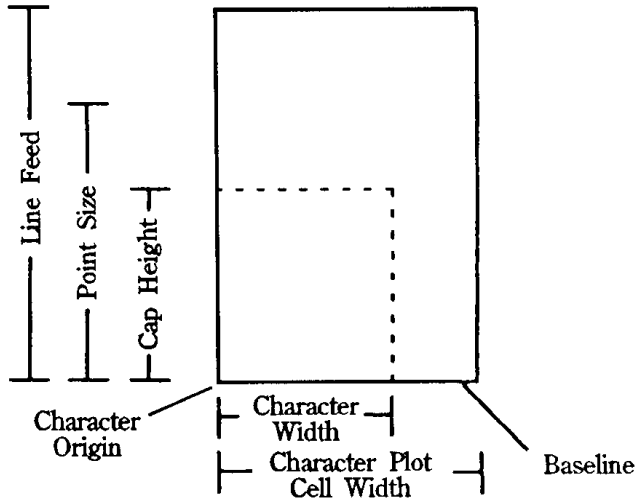

Figure 23-5 The Character Cell and HP-GL/2

Table 23-5

Term	Description
Baseline	The imaginary line on which a line of text rests. A character's descender (such as the bottom of a lowercase "g") extends below the baseline.
Linefeed	The distance from the baseline of a line of text to the baseline of the next character line above or below. For most fonts, the linefeed is about 1.2 times the point size (1.33 times the point size for Stick fonts).
Point Size	Traditional character measure roughly equivalent to the height of a capital letter M plus the depth of a descender.

Table 23-5 (continued)

Cap Height	The distance from the baseline to the top of a capital letter.
Character Origin	The point at which the baseline meets the left edge of the character cell.
Character Width	The lateral area allocated for character rendering.
Character Plot (CP) Cell Width	The distance from the left edge of one character to the beginning of the next character.
Character Plot (CP) Cell	A rectangular area with the height of a linefeed and a width extending from the beginning of one character to the beginning of the next.

The printer implements the following different types of fonts:

- Scalable outline font
- Bitmap font
- HP-GL/2 Stick and Arc font

These are described in more detail in “Using Fonts” later in this chapter. Figure 23-6 and Figure 23-7 show each type of font in relation to its character cell.

Note

Proportional fonts do not actually have a fixed character “cell.” The width occupied by each character depends on the character’s shape.

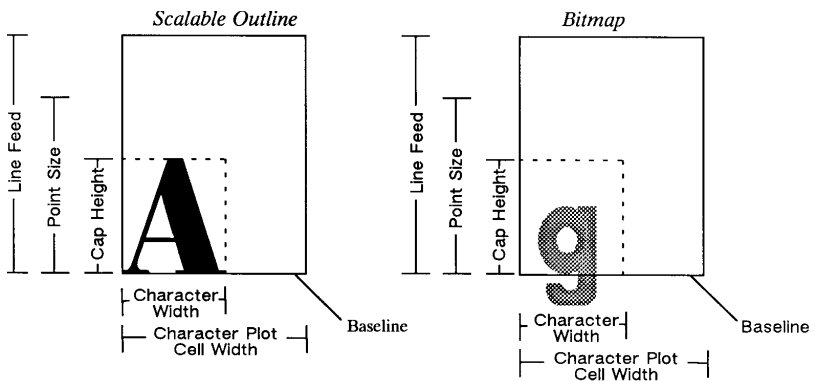

Figure 23-6 Scalable and Bitmap Character Cell

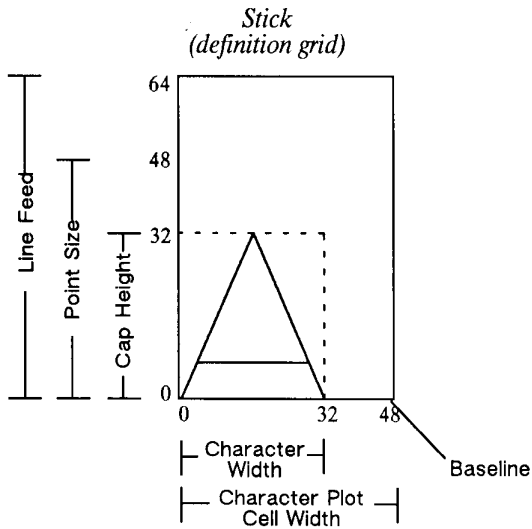

Figure 23-7 Stick Font Character Cell

When you use the SI (Absolute Character Size) or SR (Relative Character Size) commands to change the size of the characters, or use the ES (Extra Space) command to add extra space around them, you alter the size of the CP (Character Plot) cell.

You can control almost all aspects of the label's appearance: its position, size, slant, spacing, and direction. This chapter explains the commands that control these features. This chapter also tells you how to select fonts other than the default font.

Using Fonts

In HP-GL/2 mode, the printer uses three different types of fonts:

- **Scalable fonts** — Characters can be displayed at any size. The characters are defined as a set of points on the outline of a character and corresponding mathematical relationships describing the interaction between these outline points. A scalable outline character can be resized (using SI and SR), rotated (using DI and DR), and distorted (using SL).
- **Bitmap fonts** — Characters defined as an array of dots in a raster pattern. A bitmap character cannot be transformed using SI, SR, or SL, but they can be used with all of the other commands in this chapter (see the SB command). Bitmap characters are always placed in an orthogonal direction (to the PCL page) closest to the print direction established using the DI and DR commands (see Figure 23-17).
- **Stick and Arc fonts** — Characters are drawn as a series of vectors. The characters are defined as a set of endpoints. You can resize (using SI or SR), rotate (using DI and DR), and distort (using SL) Stick fonts. Stick fonts are defined on a dimensionless grid. The main body of each character fits within a 32- by 32-unit box, with descenders extending beneath. The Stick font is fixed-spaced, and the Arc font is proportional.

Printing with Fixed-Spaced and Proportional Fonts

Proportional fonts, by definition, use different amounts of horizontal space for each letter. This variation produces some differences in the definition of the character cell, and in the way some of the labeling commands work with these fonts. These differences are described in this section.

Figure 23-8 and Figure 23-9 show the difference between fixed-spaced and proportional fonts.

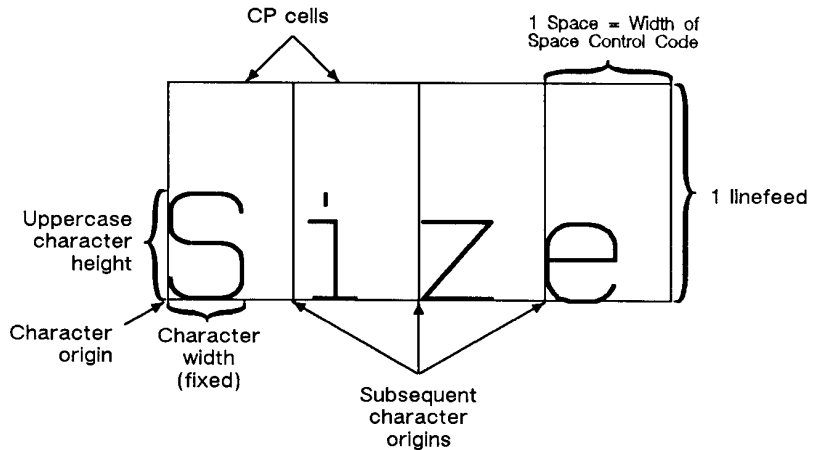

Figure 23-8 Fixed-Spaced Font

With proportional fonts, the actual space occupied by each character varies according to the character's width (Figure 23-9).

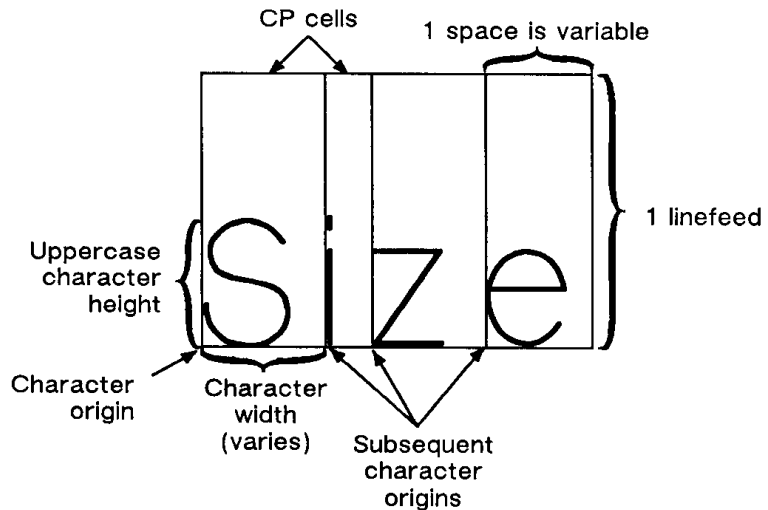

Figure 23-9 Proportional Font

When printing proportional fonts, the Character Plot (CP) command uses the width of the Space control code to determine horizontal spaces and the Line Feed height for determining vertical spacing. The Extra Space (ES) command uses the horizontal escapement distance (a font metric) to compute horizontal spaces and the Line Feed height for determining vertical spacing. Both of the character size commands (SI and SR) use cap height and average character width in calculating character size. Otherwise, these commands behave the same as they do with fixed-spaced fonts.

Designating and Selecting Fonts

If you intend to label with the default fixed-spaced font (Stick), you do not need to use the SD or AD commands for designating standard and alternate fonts. However, if you intend to use a different font (for example, to match accompanying PCL text), you must use the SD or AD commands to designate fonts before you can select those fonts for labeling (using either SA or SS).

Standard and Alternate Fonts

The following outlines some of the principles to use when labeling with different fonts:

- Designate the standard and alternate fonts using the SD and/or AD commands before labeling. If you are using the Stick font (the default) as your standard font, you need specify only your alternate font.
- Select either the standard or alternate font, using either the SS or SA command before labeling.
 - Note that labeling always begins with the standard font, unless you use the SA command before you begin your label (or finish the previous label in the alternate font).
- Switch from the standard font to the alternate font, either using SS and SA or the Shift In/Shift Out method. If you are changing fonts within a text string, the Shift In/Shift Out method is usually more efficient. Switch from the standard font to the alternate font using the ASCII Shift Out control character (SO, decimal code 14). Switch from the alternate font to the standard font using the ASCII Shift In control character (SI, decimal code 15). (Note that a Shift In or Shift Out outside of the label command string is ignored.)

AD, Alternate Font Definition

This command is similar to the Standard Font Definition (SD) command that defines the primary HP-GL/2 font. In addition the AD command defines an alternate HP-GL/2 font and its characteristics: font spacing, pitch, height, posture, stroke weight, and typeface. It allows the font characteristics to be assigned to the secondary (alternate) font definition. Use AD to set up an alternate font that you can easily access when labeling.

AD *kind,value... (,kind,value;)*

or

AD (*;*)

Parameter	Format	Functional Range	Default
kind	clamped integer	1 to 7	no default
value	clamped real	kind dependent*	kind dependent*

* Refer to the table following the parameter descriptions.

The AD command allows you to define another font and its font characteristics.

- **No Parameters** — Defaults the alternate font characteristics to that of the Stick font (see the following table).
- **Kind** — Specifies the characteristic for which you are setting a value (see the following table).

Table 23-6

Kind	Characteristic	Default Value	Description
1	Symbol Set	277	Roman-8
2	Font Spacing	0	fixed spacing
3	Pitch	9	characters per inch
4	Height	11.5	font point size
5	Posture	upright	upright

Table 23-6 (continued)

6	Stroke Weight	0	medium
7	Typeface	48	Stick (fixed vector)

- **Value** — Defines the properties of the characteristic specified by the *kind* parameter.

Note

When selecting fonts, the different characteristics (symbol set, spacing, pitch, etc.) are prioritized as shown in the table above, with symbol set being the highest priority and typeface being the lowest. The font selection priority is the same for HP-GL/2 as for PCL font selection. For more information about the priority of font characteristics, see the “Font Selection by Characteristic” discussion in Chapter 8.

Note

To avoid duplication of many pages of tables, the tables listing the *kind* parameters (symbol set, spacing, typeface, etc.) are located with the description of the SD (Standard Font Description) command.

The following example shows the command used to designate a 30-point *CG Times Bold Italic* font in the ASCII symbol set (use the Select Alternate Font (SA) command to select this font after it is designated):

AD 1,21, 2,1, 4,30, 5,1, 6,3, 7,4101

Symbol Set
Font Spacing
Height
Posture
Stroke Weight
Typeface

Note that the *pitch* parameter is missing in the above command because the designated font is proportionally spaced.

Table 23-7

Related Commands	Group
FI, Select Primary Font	<i>The Character Group</i>
FN, Select Secondary Font	
LB, Label	

Table 23-7 (continued)

SA, Select Alternate Font	
SB, Scalable or Bitmap Fonts	
SD, Standard Font Definition	
SI, Absolute Character Size	
SR, Relative Character Size	
SS, Select Standard Font	
TD, Transparent Data	

CF, Character Fill Mode

The Character Fill Mode command specifies the way scalable fonts are filled and edged; bitmap and Stick fonts cannot be edged and can be filled only with raster fill, shading, or PCL cross-hatch patterns. Scalable characters may be filled with any of the fill patterns specified by the FT command (shading, hatching, cross-hatch, and user-defined raster fill patterns).

CF *fill mode*[,edge pen[:]]

or

CF [:]

Parameter	Format	Functional Range	Default
fill mode	clamped integer	0, 1, 2, or 3	0 (solid fill)
edge pen	integer	$-(2)^{30}$ to $2^{30} - 1$	0 (no edging)

- **No Parameters**— Defaults characters to solid fill with no edging. Equivalent to CF0,0.

- **Fill mode**— Specifies how the printer renders filled characters according to the following parameter values.
 - **0**— Specifies solid fill using the current pen and edging with the specified pen (or current pen if the edge pen parameter is not specified).
 - **1**— Specifies edging with the specified pen (or current pen if the edge pen parameter is not specified). Characters are filled only if they cannot be edged (bitmap or stick characters), using the edge pen.
 - **2**— Specifies filled characters using the current fill type (refer to the FT command in Chapter 20, *The Line and Fill Characteristics Group*). The currently selected pen is used. Characters are not edged. If the edge pen parameter is specified, it is ignored.
 - **3**— Specifies filled characters using the current fill type (refer to the FT command in Chapter 20, *The Line and Fill Characteristics Group*). The currently selected pen is used. Characters are edged with the specified pen (or current pen if the edge pen parameter is not specified).
- **Edge pen**— For characters that are to be edged, this parameter indicates the pen that is used to edge the character (black or white).
- **0**—No edging.
- **1**—Black edging. The outline pen width is not selectable, but varies in thickness in proportion to the point size of the font.

Note that the Absolute Direction (DI) and Relative Direction (DR) commands do not cause rotation of fill patterns. Fill patterns remain fixed with respect to the current coordinate system. The CF command remains in effect until another CF command is executed, or the printer is initialized or set to default conditions.

Note

The edge pen width is not specifiable; its thickness automatically increases in proportion with the point size.

The thickness of fill lines for hatching and cross hatch is selected using the PW (Pen Width) command. Due to the way hatching and cross-hatch lines are drawn, they may extend beyond the character outline by up to 1/2 of the current pen width. When using a small pen width and specifying a black edge pen, the edging covers up hatching lines that extend outside the character outline. However, as the pen width increases, the edge pen may not be wide enough to compensate for this, resulting in a fill that overlaps the character edges. To ensure that the character fill looks correct when using hatching patterns, use a narrow pen width, especially for small point sizes (see illustration below).



Figure 23-10 Character Fill Overflowing

Table 23-8 Example: Using the CF Command

<code>E_CE</code>	Reset the printer.
<code>E_C%0B</code>	Enter HP-GL/2 mode.
<code>IN;</code>	Initialize HP-GL/2 mode.
<code>SP1;</code>	Select pen number 1 (black).
<code>SD1,21,2,1,4,140,5,0,6,3,7,4148;SS;</code>	Specify a 140-point Univers Bold font and select it for printing.
<code>PA1000,3000;DT*;</code>	Specify absolute plotting and move to (1000,3000); specify (*) as the label terminator.
<code>FT3,50,45;</code>	Specify a hatching fill type with 50 plotter units between each line, with the lines set at a 45° angle.
<code>CF1,1;LBA*;</code>	Select character fill mode 1 (edge) and edge with pen number 1 (black); print the letter “A”.
<code>PR127,0;</code>	Move the pen position 127 plu to the right.

Table 23-8 Example: Using the CF Command (continued)

PW.1;CF3,1;LBB*;	Set the pen width to .1 mm; select character fill mode 3 (fill & edge) and edge with pen number 1 (black); print the letter "B".
PW.5;LBC*;	Set the pen width to .5 mm to change the thickness of the fill lines; print the letter "C".
E _C %0A	Enter the PCL mode.
E _C E	Send a reset to end the job and eject the page.

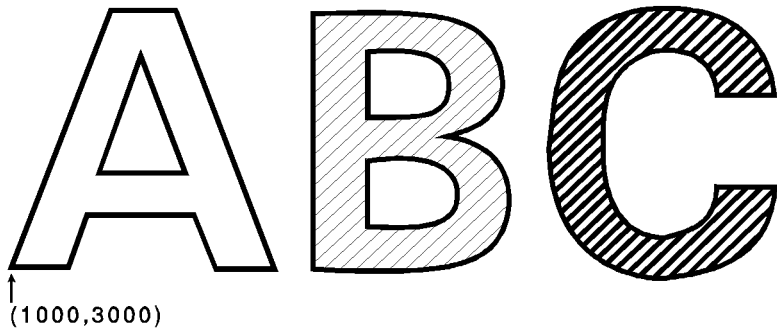

Figure 23-11

Table 23-9

Related Commands	Groups
DI, Absolute Direction DR, Relative Direction SB, Scalable or Bitmap Fonts	<i>The Character Group</i>
FT, Fill Type	<i>The Line and Fill Characteristics Group</i>

CP, Character Plot

This command moves the pen the specified number of spaces and lines from the current pen location. Use CP to position a label for indenting, centering, etc.

CP *spaces,lines* [:]

or

CP [:]

Parameter	Format	Functional Range	Default
spaces	clamped real	-32768 to 32767	no default
lines	clamped real	-32768 to 32767	no default

The CP (Character Plot) command includes an automatic pen up. When the command is completed, the original pen up/down status is restored.

CP moves the pen position in relation to the current position. CP is a movement command and does not affect the margin; to repeat the same movement for subsequent labels, you must issue new CP commands. (For information about the Carriage Return point, see “Moving to the Carriage Return Point” in the “Printing Labels” discussion near the beginning of this chapter. For more information on spaces, lines, and the character cell, refer to “Working with the Character Cell” earlier in this chapter.)

- **No Parameters**— Performs a Carriage Return and Line Feed (moves one line down and returns to the Carriage Return point).
- **Spaces**— Specifies the number of spaces the pen moves relative to the current pen location. Positive values specify the number of spaces the pen moves to the right of the current pen position; negative values specify the number of spaces the pen moves to the left. Right and left are relative to current label direction. The space width is uniquely defined for each font; use the ES command to adjust the width.

Note

If you are using a proportionally-spaced font, the width of the Space control code is used.

- Lines** — Specifies the number of lines the pen moves relative to the current pen location. Positive values specify the number of lines the pen moves up from the current pen position; negative values specify the number of lines the pen moves down (a value of -1 is equivalent to a Line Feed). Up and down are relative to the current label direction. The Line Feed distance is uniquely defined for each font; use the Extra Space (ES) command to adjust the height.

When you move the pen up or down a specific number of lines, the Carriage Return point shifts up or down accordingly.

The illustration below shows the interaction of label direction and the sign (+/-) of the parameters.

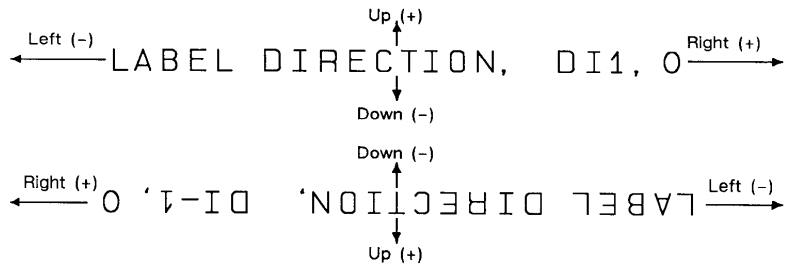

Figure 23-12 Interaction of Label Direction and Parameter Sign

The following illustration shows the direction of labeling with a vertical text path (set by (DV1) or (DV1,0); refer to the Define Variable Text Path (DV) command for more information).

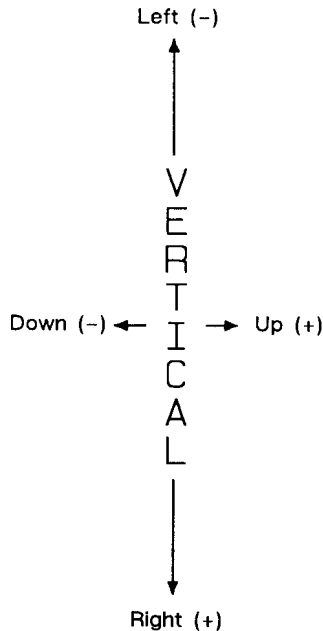

Figure 23-13 Labeling with a Vertical Text Path

The following example produces lettering along a line (but not directly on top of it), and aligns labels along a left margin. Movement of the Carriage Return point is demonstrated, as well as different methods of placing the text. The text is placed using the CP command with parameters, then with a Carriage Return-Line Feed (CR-LF) combination, and using a CP command without parameters to emulate a CR-LF.

Table 23-10 Example: Using the CP Command

$E_C E$	Reset the printer.
$E_C \%0B$	Enter HP-GL/2 mode.
IN;	Initialize HP-GL/2 mode.
SP1;	Select pen number 1 (black).

Table 23-10 Example: Using the CP Command

PA5000,2500; PD1500,2500; PU;	Specify absolute plotting and move to (5000,2500); set the pen down and draw a line to (1500,2500); lift the pen.
CP5,.35;	Move the pen 5 spaces to the right and .35 lines up so that the label is placed just above the line.
DT\$,1;	Define a label terminator (\$) and specify that it does not print.
SD1,21,2,1,4,14,5, 0,6,3,7,4148;SS;	Designate a 14-point Univers Bold font and select it.
LBAbove THE LINE\$;	Print the first line of text. The label text is shown on two lines due to the column width restriction. When coding a single line label, it should all be placed on one line.
PA2500,2500; WG20,0,360;	Move the pen to (2500,2500) and draw a dot marking the new Carriage Return point (360° black-filled wedge with a diameter of 20 plu).
CP0,-.95LBBelow THE LINECR-LF WITH A NEAT\$;	Print the second line; Carriage Return-Line Feed; print the third line.
CP;LBMARGIN\$;	Print the fourth line. Notice how the CP command without parameters functions as a CR-LF.
^E _C %0A	Enter the PCL mode.
^E _C E	Send a reset to end the job and eject the page.

ABOVE THE LINE

BELOW THE LINE
WITH A NEAT
MARGIN

Figure 23-14

Table 23-11

Related Commands	Group
DI, Absolute Direction	<i>The Character Group</i>
DR, Relative Direction	
DV, Define Variable Text Path	
ES, Extra Space	
LB, Label	
LO, Label Origin	
SB, Scalable or Bitmap Fonts	
SI, Absolute Character Size	
SR, Relative Character Size	

DI, Absolute Direction

This command specifies the slope or direction at which characters are drawn, independent of P1 and P2 settings. Use DI to change labeling direction when you are labeling curves in line charts, schematic drawings, blueprints, and survey boundaries.

DI *run,rise* [:]

or

DI [:]

Table 23-12

Parameter	Format	Functional Range	Default
run (or $\cos \theta$)	clamped real	-32768 to 32767	1
rise (or $\sin \theta$)	clamped real	-32768 to 32767	0

The DI command updates the Carriage Return point to the current location. While DI is in effect, with or without parameters, the label direction is not affected by changes in the locations of P1 and P2. However, the Define Variable Text Path (DV) command interacts with the DI command (and DR), as explained later in this section.

- **No Parameters** — Defaults the label direction to absolute and horizontal (parallel to X-axis). Equivalent to (DI1,0).
- **Run or Cos θ** — Specifies the X-component of the label direction.
- **Rise or Sin θ** — Specify the Y-component of the label direction.
 - Together, the parameters specify the slope and direction of the label.

You can express the parameters in measured units as rise and run, or using the trigonometric functions cosine and sine according to the following relationship.

Where: run and rise = number of measured units

θ = the angle measured in degrees

$\sin \theta / \cos \theta = \text{rise/run}$

$\theta = \tan^{-1}(\text{rise/run})$

and

$\tan \theta = \sin \theta / \cos \theta$

Note that the run and rise determine the slope or angle of an imaginary line under the base of each character in the label. Refer to the following illustration.

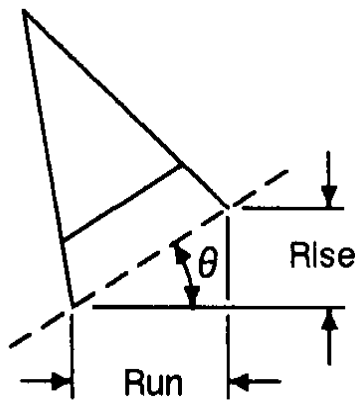

Figure 23-15 Character Slope Rise and Run

When plotting in horizontal mode (you have not used the DV command), the run and rise appear to determine the slope of the entire label. However, if you have used the Define Variable Text Path (DV) command to label in a vertical path, the label appears to slant in the opposite direction, even though the base of each letter is plotted on the same slope. The following illustration compares how labels plotted with the same run and rise parameters appear with horizontal (DV0) and vertical (DV1) text paths.

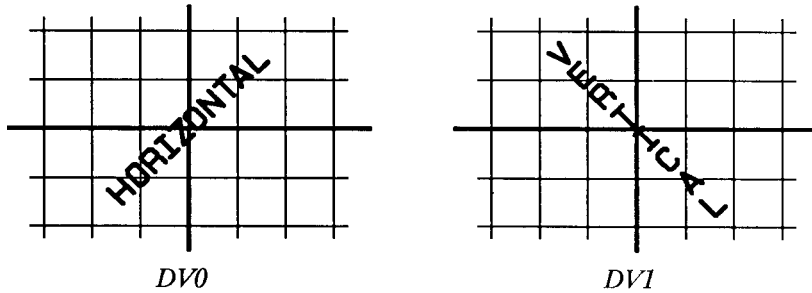

Figure 23-16 Effect of Horizontal and Vertical Text Paths

Note

If an SB1; command has been sent, the printer draws the label along the nearest perpendicular. In the case of bisection, the angle is rounded down (e.g., 45° would round to 0°). Refer to the following illustration.

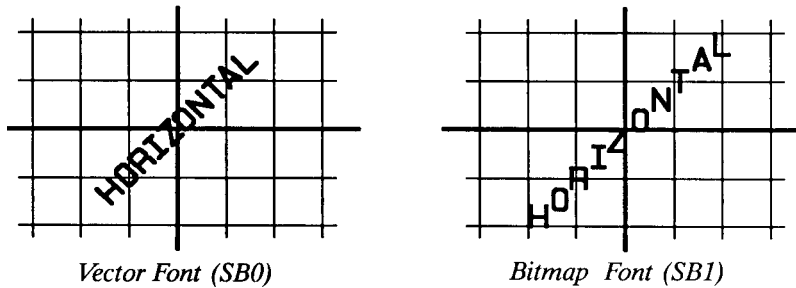
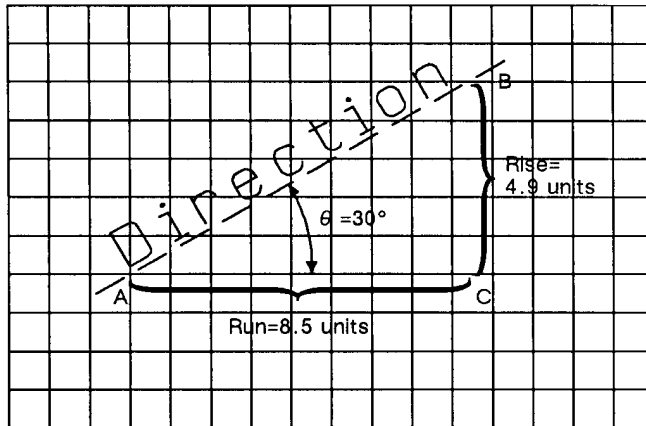

Figure 23-17 Scalable Versus Bitmap Variable Text Path Printing

Suppose you want your label plotted in the direction shown in the following illustration. You can do this in one of two ways: measure the run and rise, or measure the angle.



(D18.5,4.9)
(D1.866,.5)

Figure 23-18 Label Print Direction Rise and Run

To measure the run and rise, first draw a grid with the lines parallel to the X- and Y-axis. The grid units should be the same size on all sides, but their actual size is irrelevant. Then, draw a line parallel to the label and one parallel to the X-axis. The lines should intersect to form an angle.

Select a point on the open end of your angle (where another line would create a triangle). On the line parallel to the X-axis, count the number of grid units from the intersection of the two lines to your selected point. This is the run. In the illustration above, the run is 8.5. Now, count the number of units from your selected point along a perpendicular line that intersects the line along the label. This is the rise. In the illustration above, the rise is 4.9.

Your DI command using the run and rise is (DI8.5,4.9).

If you know the angle (θ), you can use the trigonometric functions sine (sin) and cosine (cos). In this example, $\theta = 30^\circ$, $\cos 30^\circ = 0.866$, and $\sin 30^\circ = 0.5$.

Your DI command using the sine and cosine would be (DI.866,.5).

Whichever set of parameters you use, the label is drawn in the same direction as shown in the previous illustration.

When using either method, at least one parameter must not be zero. The ratio of one parameter to the other is more important than the actual numbers. The following table lists three common label angles produced by using 1's and 0's.

Table 23-13

DI Command	Label Direction
DI 1,0	horizontal
DI 0,1	vertical
DI 1,1 or DI 0.7,0.7 (or any parameters equal to each other)	45° angle

The relative size and sign of the two parameters determine the amount of rotation. If you imagine the current pen location to be the origin of a coordinate system for the label, you can see that the signs of the parameters determine which quadrant the label is in.

Table 23-14 Example: Using the DI Command

$E_C E$	Reset the printer.
$E_C \%0B$	Enter HP-GL/2 mode.
IN;	Initialize HP-GL/2 mode.
SP1;	Select pen number 1. Even though there is no physical pen, the SP command must be used to enable printing.
PA3500,2500;	Enter absolute plotting mode and move to (3500,2500).
DT*;	Define (*) as the label terminator.
DI1,1;LB DIRECTIONCR*;	Print the word "DIRECTION" in the first quadrant and send a Carriage Return to return the pen to the Carriage Return point (3500,2500).
DI1,-1;LB DIRECTIONCR*;	Print the same word in the fourth quadrant and return the carriage to the Carriage Return point.

Table 23-14 Example: Using the DI Command (continued)

DI-1,-1;LB DIRECTIONCR*;	Print the same word in the third quadrant and Carriage Return.
DI-1,1;LB DIRECTIONCR*;	Print the word in the fourth quadrant and Carriage Return.
E _C %0A	Enter the PCL mode.
E _C E	Send a reset to end the job and eject the page.

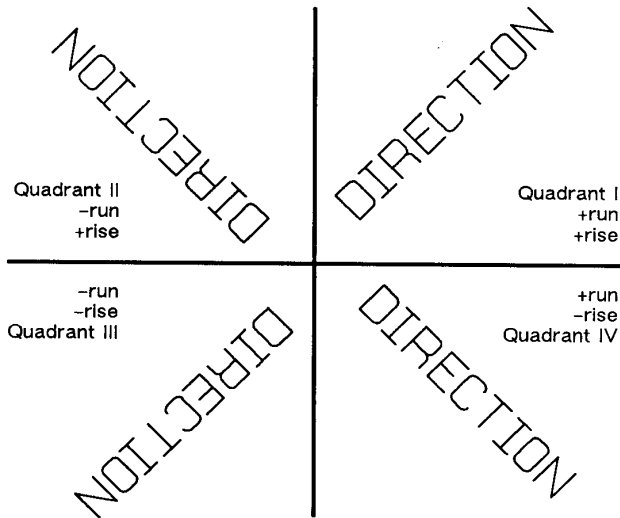

Figure 23-19 Varying Print Direction with DI Command Parameter Sign

The DI command remains in effect until another DI or DR command is executed, or the printer is initialized or set to default conditions.

The following example illustrates the use of positive and negative parameters, the use of the cosine and sine, how the LB command updates the current pen location, and how DI updates the Carriage Return point.

Table 23-15 Example: Another DI Example

E _C E	Reset the printer.
E _C %0B	Enter HP-GL/2 mode.
IN;	Initialize HP-GL/2 mode.
SP1;	Select pen number 1. Even though there is no physical pen, the SP command must be used to enable printing.
PA3500,2500;	Specify absolute plotting and move to (3500,2500).
DT#,1;	Define the “#” character as the label terminator.
DI0,1;LB__1990#;	Set the label direction to print at 90° and print “__1990”.
DI1,1;LB__1991#;	Set the label direction to 45° and print “__1991”.
DI1,0;LB__1992#;	Set the label direction to 0° and print “__1992”;
DI,.71,-.71; LB1993#;	Change the label direction using the cosine and sine of 315° and print “__1993”.
DI,0,-1;LB__1994 CR#;	Change the label direction using the cosine and sine of 270° and print “__1994”; Carriage Return.
DI,-.71,-.71; LB__1995 CR#;	Set the label direction using the cosine and sine of 270° and print “__1995”; Carriage Return.
DI,-1,0;LB__1996 CR#;	Set the label direction using the cosine and sine of -180° and print “__1996”; Carriage Return.
E _C %0A	Enter the PCL mode.
E _C E	Send a reset to end the job and eject the page.

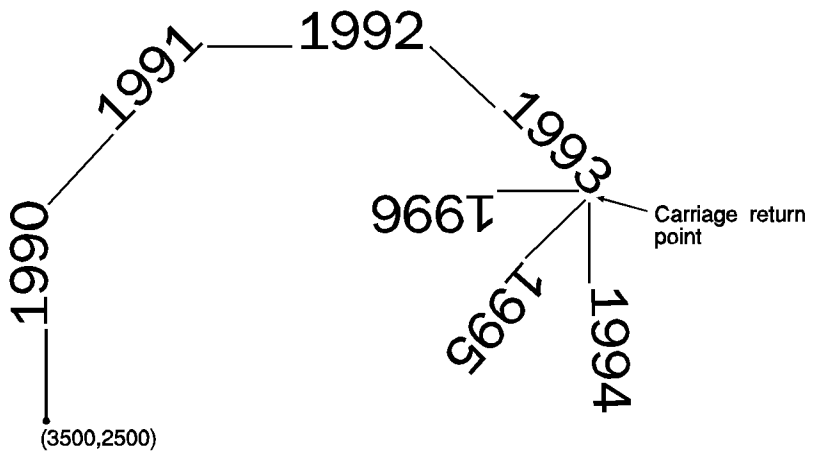

Figure 23-20

Table 23-16

Related Commands	Group
CF, Character Fill Mode	<i>The Character Group</i>
CP, Character Plot	
DR, Relative Direction	
DV, Define Variable Text Path	
LB, Label	
SB, Scalable or Bitmap Fonts	
SI, Absolute Character Size	
SL, Character Slant	
SR, Relative Character Size	

Table 23-17 POSSIBLE ERROR CONDITIONS

Error Condition	Printer Response
both parameters = 0 or number out of range	ignores command

DR, Relative Direction

This command specifies the direction in which labels are drawn, relative to the scaling points P1 and P2. Label direction is adjusted when P1 and P2 change so that labels maintain the same relationship to the scaled data. Use DR to change labeling direction when you are labeling curves.

DR *run,rise[:]*

or

DR *[:]*

Table 23-18

Parameter	Format	Functional Range	Default
run	clamped real	-32768 to 32767	1% of $P2_x - P1_x$
rise	clamped real	-32768 to 32767	0

The DR command updates the Carriage Return point to the current location. While DR is in effect, with or without parameters, the label direction is affected by changes in the location of P1 and P2. DR is also affected by the Define Variable Text Path (DV) command. Refer to the DI command earlier in this chapter for an explanation of this interaction.

- **No Parameters**— Defaults the label direction to relative and horizontal (parallel to the X-axis). Equivalent to (DR1,0).
- **Run**— Specifies a percentage of the distance between $P1_x$ and $P2_x$.
- **Rise**— Specifies a percentage of the distance between $P1_y$ and $P2_y$.

You define the parameters of run and rise as shown in the following illustration:

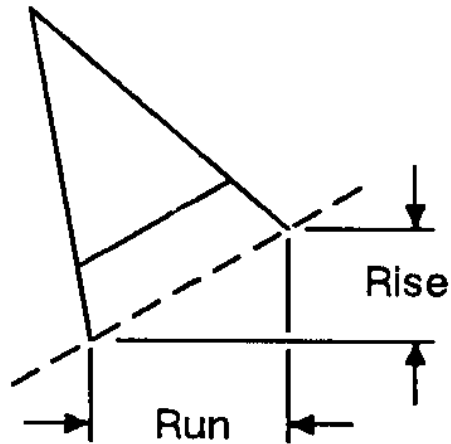

Figure 23-21 Rise and Run Parameters

With the DR command, the use of run and rise is somewhat different than with DI. Run is expressed as a percentage of the horizontal distance between P1 and P2; rise is expressed as a percentage of the vertical distance between P1 and P2.

$$\text{actual run} = \text{run parameter} \div 100 \times (P2_X - P1_X)$$

$$\text{actual rise} = \text{rise parameter} \div 100 \times (P2_Y - P1_Y)$$

The following illustration shows the effects of using three different sets of run/rise parameters. Notice how the text baseline varies as the run percentage is greater than, equal to, and less than the value for rise.

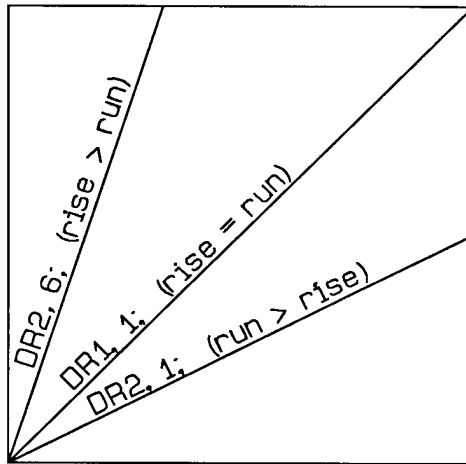

Figure 23-22 Effects of Different Rise/Run Parameters

If the P1/P2 rectangle is square, the DR and DI commands have exactly the same effect. The advantage of using the DR command is that, as the locations of P1 and P2 change, the slope of the baseline changes to match the stretching or compressing of the P1/P2 rectangle. For example, if the relative direction is set so that rise = run, the slope of the baseline is 45° as long as the P1/P2 rectangle is square. If the P1/P2 rectangle stretches so that it is twice as high as it is wide, the slope of the baseline remains parallel to an imaginary line running from P1 to P2 (see illustration below).

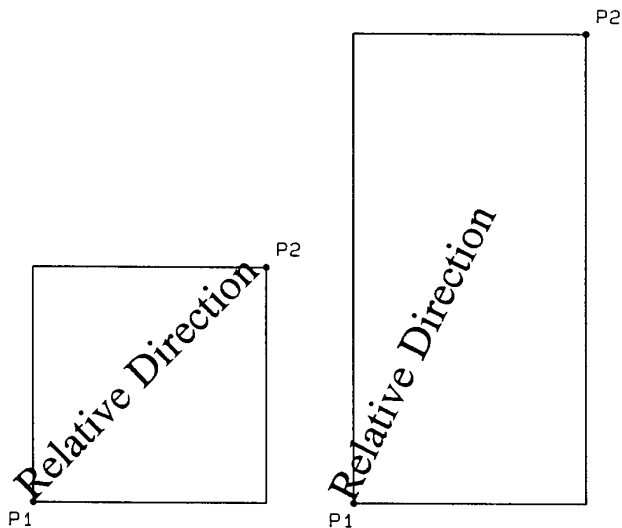

Figure 23-23 Effects of Scaling on Label Direction

Labels begin at the current pen location and thus are drawn parallel to the directional line, not necessarily on it. Also, negative parameters have the same effect on direction as described for the DI command.

At least one parameter must not be zero. The ratio of the parameters to each other is more important than the actual numbers. The table below lists three common label angles produced by using ones and zeros.

Table 23-19

DR Command	Label Direction
DR 1,0	horizontal
DR 0,1	vertical
DR 1,1 or DI 0.7,0.7 (any parameters equal to each other)	diagonal from P1 to P2

The relative size and sign of the two parameters determine the amount of rotation. If you imagine the current pen location to be the origin of a coordinate system for the label, you can see that the signs of the parameters determine in which quadrant the label is in.

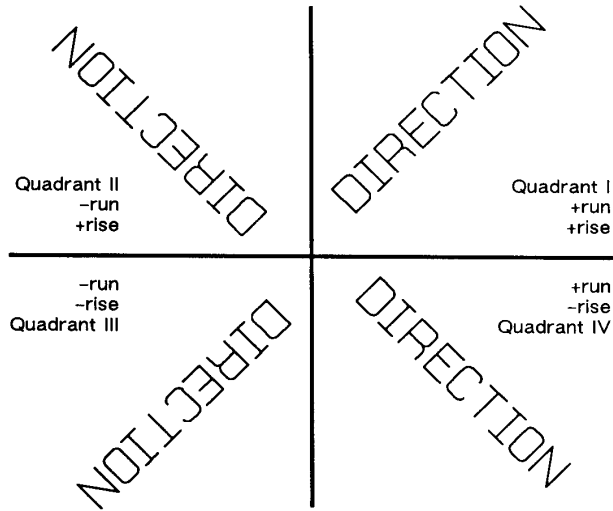

Figure 23-24 Varying Print Direction with DR Command Parameter Sign

A DR command remains in effect until another DR or DI command is executed, or until the printer is initialized or set to default conditions.

Example: Using the DR Command

This example illustrates the use of positive and negative parameters, how the LB command updates the current pen location, and how DR updates the Carriage Return point.

Note that this is the same example shown with the DI command. The only changes are switching the DI to DR and using the 1:0 ratio instead of the sine and cosine. However, if you print them both and measure them, you'll discover that they are slightly different sizes. The size difference results from the DR command's use of the percentage of the P2/P1 distance.

Note

Labels begin at the current pen location and thus are drawn parallel to the directional line, not necessarily on it.

Table 23-20 Example: Using the DR Command

$E_C E$	Reset the printer.
$E_C \%0B$	Enter HP-GL/2 mode.
IN;	Initialize HP-GL/2 mode.
SP1;	Select pen number 1 (black).
PA3500,2500;	Specify absolute plotting and move to (3500,2500).
DT#,1;	Define the “#” character as the label terminator.
DR0,1;LB __1990#;	Set the label direction and print “__1990”.
DR1,1;LB __1991#;	Set the label direction and print “__1991”.
DR1,0;LB__1992#;	Set the label direction and print “__1992”.
DR,1,-1; LB__1993#;	Change the label direction and print “__1993”.
DR,0,-1;LB__1994 CR#;	Set the label direction, print “__1994” and Carriage Return.
DR,-1,-1;LB__1995 CR#;	Set the label direction and print “__1995”; Carriage Return.
DR,-1,0;LB__1996 CR#;	Set the label direction and print “__1996”; Carriage Return.
$E_C \%0A$	Enter the PCL mode.
$E_C E$	Send a reset to end the job and eject the page.

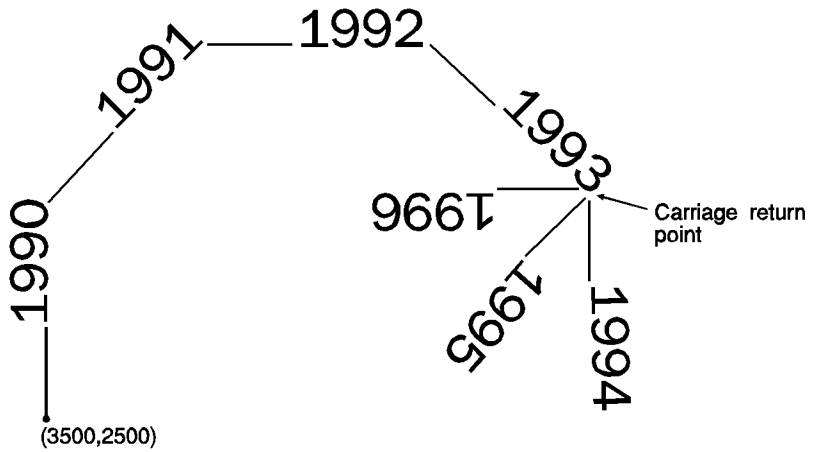

Figure 23-25

Table 23-21

Related Commands	Group
CF, Character Fill Mode CP, Character Plot DI, Absolute Direction DV, Define Variable Text Path LB, Label SB, Scalable or Bitmap Fonts SI, Absolute Character Size SL, Character Slant SR, Relative Character Size	<i>The Character Group</i>
IP, Input P1 and P2 IR, Input Relative P1 and P2	<i>The Configuration/Status Group</i>

Table 23-22 POSSIBLE ERROR CONDITIONS:

Error Condition	Printer Response
both parameters = 0 or number out of range	ignores command

DT, Define Label Terminator

This command specifies the character to be used as the label terminator and whether it is printed. Use DT to define a new label terminator if you desire a different one or if your computer cannot use the default (ETX, decimal code 3).

DT *label terminator* [,mode;]

or

DT;

Parameter	Format	Functional Range	Default
label terminator	label text	any character except NULL, LF, E_C , and ; (decimal codes 0, 5, 27, and 59 respectively)	ETX (decimal code 3)
mode	clamped integer	0 or 1	1 (non-printing)

The character immediately following DT is interpreted to be the new label terminator. You must terminate all Label (LB) commands following a DT command with the specified label terminator.

- **No Parameter**— Defaults the label terminator to ETX (not a semicolon) and the mode to non-printing (1).
- **Label Terminator**— Specifies the label terminator as the character immediately following the DT mnemonic. (If you use a space between the mnemonic and the label terminator parameter the space becomes the label terminator.)

- **Mode**— Specifies whether the label terminator is printed.
 - 0**— The label terminator prints if it is a printable character and performs its function if it is a control code.
 - 1**— (Default) The label terminator does not print if it is a printing character and does not perform its function if it is a control code.

A DT command remains in effect until another DT command is executed, or the printer is initialized or set to default conditions.

The following command shows how to define and print using a non-printing label terminator:

```
DT#;LBThe label terminator WILL NOT print.#;
```

This command would print as:

The label terminator WILL NOT print.

This example shows how to define and use a printable label terminator:

```
DT#,0;LBThe label terminator WILL print.#;
```

This command would print as:

The label terminator WILL print.#

For another example using the DT command, see the example in the Character Plot (CP) command discussion.

Table 23-23

Related Commands	Group
LB, Label TD, Transparent Data	<i>The Character Group</i>

DV, Define Variable Text Path

This command specifies the text path for subsequent labels and the direction of Line Feeds as either right, left, up, or down. Use DV to “stack” characters in a column.

DV *path[,line;]*

or

DV [*i*]

Parameter	Format	Functional Range	Default
path	clamped integer	0, 1, 2, or 3	0 (horizontal)
line	clamped integer	0 or 1	0 (normal Line Feed)

The DV command determines the *text path*, the direction that the current location moves after each character is drawn and the direction that the Carriage Return point moves when a Line Feed is included in the label string.

- **No Parameter**— Defaults the text path to horizontal (not stacked) with normal Line Feed. Equivalent to (DV0,0).
- **Path**— Specifies the location of each character with respect to the preceding character, relative to the labeling direction defined by the DI or DR commands. The text path set by DV is not affected by changes in P1 and P2.
 - **0 — 0 degrees.**(Right) Within a label, each character begins to the right of the previous character. This is a horizontal text path (unless altered by DI or DR).
 - **1 — -90 degrees.**(Down) Within a label, each character begins below the previous character. This is a vertical text path (unless altered by DI or DR).
 - **2 — -180 degrees.**(Left) Within a label, each character begins to the left of the previous character. This is a horizontal text path (unless altered by DI or DR).

- **3 — -270 degrees.**(Up) Within a label, each character begins above the previous character. This is a vertical text path (unless altered by DI or DR).

The following illustration shows the four text paths.

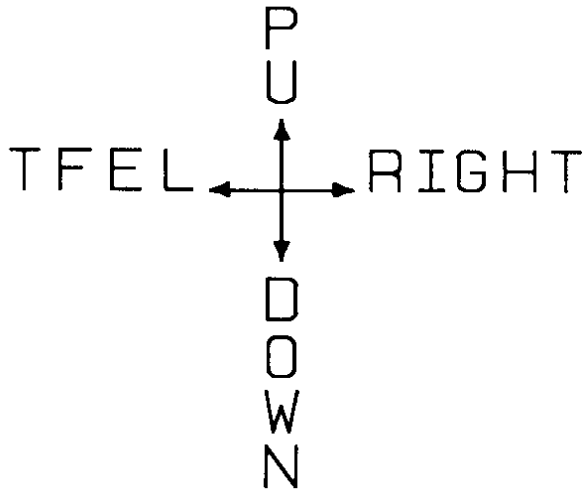

Figure 23-26 Four Text Paths

- **Line**— Specifies the location of each character with respect to the preceding character, relative to the labeling direction defined by the DI or DR commands.
- **0 — -90 degrees.**(Normal Line Feed) Sets the direction of Line Feeds -90 degrees with respect to the text path.

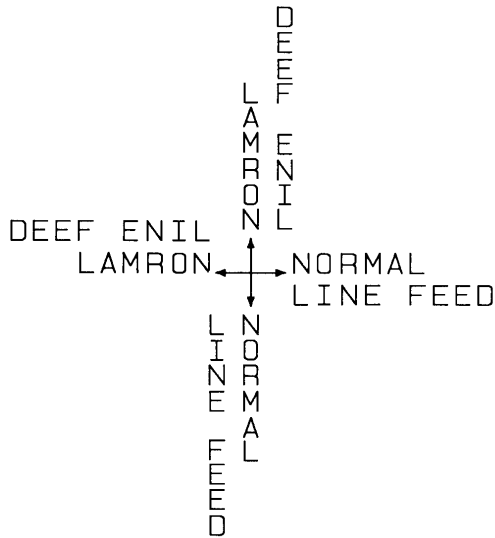

Figure 23-27 DV Command Character Position for Normal (0) Parameter

- **0 — +90 degrees.**(Reverse Line Feed) Sets the direction of Line Feeds +90 degrees with respect to the text path.

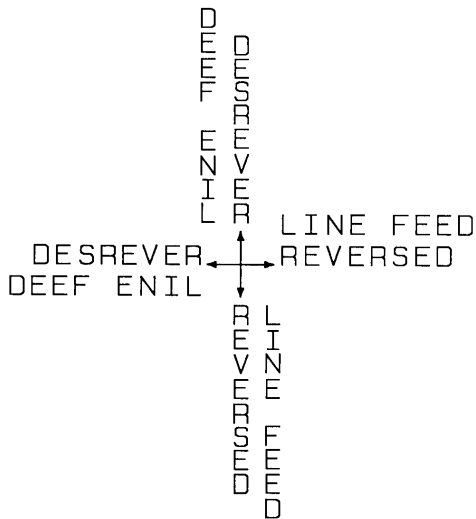

Figure 23-28 DV Command Character Position for Normal (90) Parameter

Example:Using theDV Command

The following example illustrates how Line Feeds and Carriage Returns affect vertical labels. Horizontal labels are shown for comparison.

Table 23-24 Example: Using the DV Command

$E_C E$	Reset the printer.
$E_C \%0B$	Enter HP-GL/2 mode.
IN;	Initialize HP-GL/2 mode.
SP1;	Select pen number 1. Even though there is no physical pen, the SP command must be used to enable printing.
PA2000,3000;DV1;	Specify absolute plotting and move to (2000,3000). Define the text path so that each character begins below the previous character (vertical text path).
DT@;	Define the "@" character as the label terminator (non-printing).
LBABC <i>CR-LF</i> @;	Print ABC, followed by a Carriage Return/Line Feed (CR-LF).
LBDEF <i>LF</i> @;	Print DEF, followed by a Line Feed.
LBGHI <i>LF</i> @;	Print GHI, followed by a Line Feed.
LO3;	Change the label Origin to 3 (the default LO1 was used prior to this).
LBJKL @	Print JKL.
LO1;	Return to the default label Origin (LO1).
PA4000,3000;DV0;	Move to (4000,3000) and define the text path so that each character begins to the right of the previous one (horizontal [default] text path).
LBABC <i>CR-LF</i> @;	Print ABC, followed by CR-LF.
LBDEF <i>LF</i> @;	Print DEF, followed by Line Feed.
LBGHI@;	Print GHI (without CR or LF).

Table 23-24 Example: Using the DV Command (continued)

E _C %0A	Enter the PCL mode.
E _C E	Send a reset to end the job and eject the page.

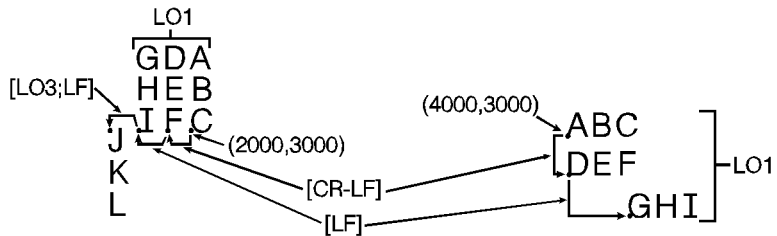

Figure 23-29

Table 23-25

Related Commands	Group
CP, Character Plot	<i>The Character Group</i>
DI, Absolute Direction	
DR, Relative Direction	
LB, Label	
LO, Label Origin	

Note

Used with specific LO (Label Origin) settings, labels can be concatenated (see LO command description, later in this chapter).

ES, Extra Space

This command adjusts space between characters and lines of labels without affecting character size.

ES *width[,height;]*

or

ES *[:]*

Parameter	Format	Functional Range	Default
width	clamped real	-32768 to 32767	0
height	clamped real	-32768 to 32767	0

The printer interprets the parameters as follows:

- **No Parameters**— Defaults the spaces and lines between characters to no extra space. Equivalent to (ES0,0).
- **Width**— Specifies an increase (positive number) or decrease (negative number) in the space between characters. For maximum legibility, do not specify more than one extra space or subtract more than half a space.
- **Height**— Specifies an increase (positive number) or decrease (negative number) in the space between lines. For maximum legibility, do not specify more than two extra lines, or subtract more than half a line.

An ES command remains in effect until another ES command is executed, or until the printer is initialized or set to default conditions.

Table 23-26 Example: Using the ES Command

$E_C E$	Reset the printer.
$E_C \%0B$	Enter HP-GL/2 mode.
IN;	Initialize HP-GL/2 mode.
SP1;	Select pen number 1. Even though there is no physical pen, the SP command must be used to enable printing.

Table 23-26 Example: Using the ES Command (continued)

PA2500,3200; SI.187,.269;	Specify absolute plotting and move to (2500,3200); specify a relative character size of .187 cm wide by .269 cm high.
DT#;ES;	Define the “#” character as the label terminator and set the extra space setting to default (no extra space).
LBES; CAUSES#;	Print “ES; CAUSES”.
CP;LBTHIS SPACING.#;	Send a CP command as a CR-LF and print “THIS SPACING.”
PA2500,2500;	Move to (2500,2500).
ES-.1,-.25; LBES-.1,-.25; CAUSES#;	Decrease the inter-character spacing by .1 and the inter-line spacing by .25; print “ES-.1,-.25; CAUSES”.
CP;LBTHIS SPACING.#;	Send CP in place of CR-LF and print “THIS SPACING.”
PA2500,1800;	Move to (2500,1800).
ES.2,.25;LBES.2,.25; CAUSES#;	Increase the inter-character spacing by .2 and the inter-line spacing by .25 of the Space control code; print “ES.2,.25; CAUSES”.
CP;LBTHIS SPACING.#;	Send CP in place of CR-LF and print “THIS SPACING.”
$E_C\%0A$	Enter the PCL mode.
$E_C E$	Send a reset to end the job and eject the page.

ES; CAUSES
THIS SPACING.

ES-.1, -.25; CAUSES
THIS SPACING.

ES.2, .25; CAUSES
THIS SPACING.

Table 23-27

Related Commands	Group
CP, Character Plot LB, Label	<i>The Character Group</i>

FI, Select Primary Font

This command allows any accessible font that has been assigned a *font ID* number to be selected as the primary (standard) font (the font characteristics are assigned to the standard font). As mentioned, the font must be accessible to the printer as either a resident font, a downloaded font, or a loaded cartridge font. To be selected, the font must have been previously assigned a font ID number in PCL mode. Also, for scalable fonts, the FI command must be preceded by an SD command specifying the font's point size or pitch (see the "Using the FI Command" example).

FI *font_ ID[:]*

Parameter	Format	Functional Range	Default
font_ID	integer	0 to 32767	no default

When the printer receives this command and the requested font is present, the primary font characteristics are set to those of the requested font. If the selected font is proportionally spaced, the pitch characteristic is not changed.

Notes

This command does not select the font for label printing if you are currently using the alternate font.

The FI and FN commands implicitly change the value of SB. For example, if SB = 0 and FI selects a bitmap font, SB is set to 1. This affects the performance of certain HP-GL/2 commands. Refer to SB command later in this chapter.

Example:Using the FI Command

The following example demonstrates assigning a font ID number from within PCL mode, entering HP-GL/2 mode, using the FI command to select that font, and printing a short line of text.

Table 23-28 Example: Using the FI Command

$E_C E$	Reset the printer.
$E_C *c15D$	Specify a font ID number of 15.
$E_C(s1p18v0s3b4148T$	Select an 18-point Univers Bold font as the primary font.
$E_C *c6F$	Assign the currently selected font as a temporary font with the current ID number (15).
$E_C \%0B$	Enter HP-GL/2 mode.
IN;	Initialize HP-GL/2 mode.
SP1;	Select pen number 1. Even though there is no physical pen, the SP command must be used to enable printing.
PA1500,1500;	Move to location (1500,1500).
DT#;	Define “#” as a label terminator (non-printing).
LBLaserJet Printers <i>CR-LF#</i> ;	Print “LaserJet Printers” in the currently selected font, which is the default Stick font; Carriage Return/Line Feed. (Note, label text should not contain carriage-returns or any control codes unless specifically desired for plotting. It is shown here on two lines (with a Carriage Return) for convenience only.
SD4,18;FI15;SS:	Use the SD command to designate an 18-point font from within HP-GL/2 mode; then select the PCL font with font ID number of 15 as the primary font. Then select the primary font for printing.
LBLaserJetPrinters#;	Print “LaserJet Printers” in the newly selected font.
$E_C \%0A$	Enter the PCL mode.
$E_C E$	Send a reset to end the job and eject the page.

LaserJet Printers

LaserJet Printers

Figure 23-30

Table 23-29

Related Commands	Group
AD, Alternate Font Definition LB, Label SA, Select Alternate Font SD, Standard Font Definition SS, Select Standard Font	<i>The Character Group</i>
E _C (#X, Select Primary Font by ID # E _C)#X, Select Secondary Font by ID # E _C *c#D, Assign Font ID E _C *c6F, Font Control, Copy Assign	<i>PCL Commands</i>

FN, Select Secondary Font

This command allows any accessible font that has been assigned a *font ID* number to be selected as the secondary (alternate) font (the font characteristics are assigned to the secondary font). The font must be accessible to the printer as either a resident font, a downloaded font, or a loaded cartridge font. To be selected, the font must have been previously assigned a font ID number in PCL mode. Also, the FN command must be accompanied by an AD command specifying the font's point size (see the "Using the FI Command" example).

FN *font_ID*[:;]

Parameter	Format	Functional Range	Default
font_ID	integer	0 to 32767	no default

When the printer receives this command and the requested font is present, the secondary font characteristics are set to those of the requested font. If the selected font is proportionally spaced, the pitch characteristic is not changed.

Notes

This command does not select the font for label printing if you are currently using the standard font.

The FI and FN commands implicitly change the value of SB. For example, if SB = 0 and FI selects a bitmap font, SB is set to 1. This affects the performance of certain HP-GL/2 commands. Refer to SB command later in this chapter.

Example:Using the FN Command

The following example demonstrates assigning a font ID number from within PCL mode, entering HP-GL/2 mode, using the FN command to select that font, and printing a short line of text.

Table 23-30 Example: Using the FN Command

$E_C E$	Reset the printer.
$E_C *c28D$	Specify a font ID number of 28.
$E_C (s1p18v0s3b4148T$	Select an 18-point Univers Bold font as the primary font.
$E_C *c6F$	Assign the currently selected font as a temporary font with the current ID number (28).
$E_C \%0B$	Enter HP-GL/2 mode.
IN;	Initialize HP-GL/2 mode.
SP1;	Select pen number 1. Even though there is no physical pen, the SP command must be used to enable printing.
PA1500,1500;	Move to location (1500,1500).
DT#;	Define “#” as a label terminator (non-printing).

Table 23-30 Example: Using the FN Command

LBLaserJetPrinters <i>CR-LF#;</i>	Print "LaserJet Printers" in the currently selected font, which is the default Stick font; Carriage Return/Line Feed.
AD4,18;FN28;SA;	Use the AD command to designate an 18-point font from within HP-GL/2 mode; then assign the PCL font with font ID number of 28 as the secondary font. Then select the font.
LBLaserJetPrinters#;	Print "LaserJet Printers" in the newly selected font.
$E_C\%0A$	Enter the PCL mode.
$E_C E$	Send a reset to end the job and eject the page.

LaserJet Printers
LaserJet Printers

Figure 23-31

Table 23-31

Related Commands	Group
AD, Alternate Font Definition LB, Label SA, Select Alternate Font SD, Standard Font Definition SS, Select Standard Font	<i>The Character Group</i>

Table 23-31

$E_C^*c\#D$, Font ID (assign)	<i>PCL Commands</i>
E_C^*c6F , Font Control, Copy Assign	
$E_C(\#X$, Designate Font # as Primary	
$E_C)\#X$, Designate Font # as Secondary	

LB, Label

This command prints text using the currently defined font. Use LB to annotate drawings or create text-only charts.

LB *text . . . text label terminator*

Parameter	Format	Functional Range	Default
text . . . text	character	any character(s)	no default

The LB command includes an automatic *pen down* function. When the command is completed, the original pen up/down status is restored.

- **text . . . text**— ASCII characters. are drawn using the currently selected font. (Refer to AD, SA, SD, and SS commands for details on specifying and selecting fonts.)

You can include non-printing characters such as the Carriage Return (CR, decimal code 13) and Line Feed (LF, decimal code 10). These characters invoke the specified function, but are not drawn. Refer to Appendixes A and B of the *PCL 5 Comparison Guide* for a list of ASCII characters.

The label begins at the current pen location, (unless altered by LO). After each character is drawn, the pen location is updated to be the next character origin. (Refer to “Working With the Character Cell” earlier in the chapter.)

- Label Terminator**— Terminates the LB command. You must use the special label terminator (refer to the DT command) to tell the printer to exit the label mode. If you do not use the label terminator, everything following the LB mnemonic is printed in the label, including other commands. The default label terminator is the non-printing end-of-text character ETX (decimal code 3). You can define a different terminator using the DT command.

Table 23-32 Example: Printing Text with the LB Command

$E_C E$	Reset the printer.
$E_C \%0B$	Enter HP-GL/2 mode.
IN;	Initialize HP-GL/2 mode.
SP1;	Select pen number 1. Even though there is no physical pen, the SP command must be used to enable printing.
PA2500,2500;	Move to absolute location (2500,2500).
DT*;	Specify the asterisk (*) as the label terminator.
SD1,21,2,1,4,25,5,0,6,3,7,4148;SS;	Designate the 25-point Univers Bold font as the standard font and select it.
LBThis is a Label.*;	Prints "This is a Label." in the currently selected font.
$E_C \%0A$	Enter the PCL mode.
$E_C E$	Send a reset to end the job and eject the page.

This is a Label.

 (2500,2500)

Figure 23-32

Table 23-33

Related Commands	Group
AD, Alternate Font Definition	<i>The Character Group</i>
CP, Character Plot	
DI, Absolute Direction	
DR, Relative Direction	
DT, Define Label Terminator	
DV, Define Variable Text Path	
ES, Extra Space	
FI, Select Primary Font	
FN, Select Secondary Font	
LO, Label Origin	
SA, Select Alternate Font	
SB, Scalable or Bitmap Fonts	
SD, Standard Font Definition	
SI, Absolute Character Size	
SL, Character Slant	
SR, Relative Character Size	
SS, Select Standard Font	
TD, Transparent Data	

LO, Label Origin

This command positions labels relative to the current pen location. Use the LO command to center, left justify, or right justify labels. The label can be drawn above or below the current pen location and can also be offset by an amount equal to .25 times the point size (or 16 grid units [0.33 times the point size] for the Stick font).

LO *position[:]*

or

LO *[:]*

Parameter	Format	Functional Range	Default
position	clamped integer	1 to 9 11 to 19 21	1

The printer interprets the parameters as follows:

- **No Parameters**— Defaults the label origin. Equivalent to (LO1).
- **Position**— The position numbers are graphically illustrated below. Each dot represents the current pen location.

The label positions LO 11 through LO 19 differ from LO 1 through LO 9 only in that the labels are offset from the current pen location.

The label position 21 provides a PCL-compatible label origin. The character(s) are printed at the same location as in PCL.

Notes

Label origins do not change text path. To change the text path, use the Define Variable Text Path (DV) command.

Label position 21 is not shown in Figure 23-33 because the exact location is dependent on the PCL position.

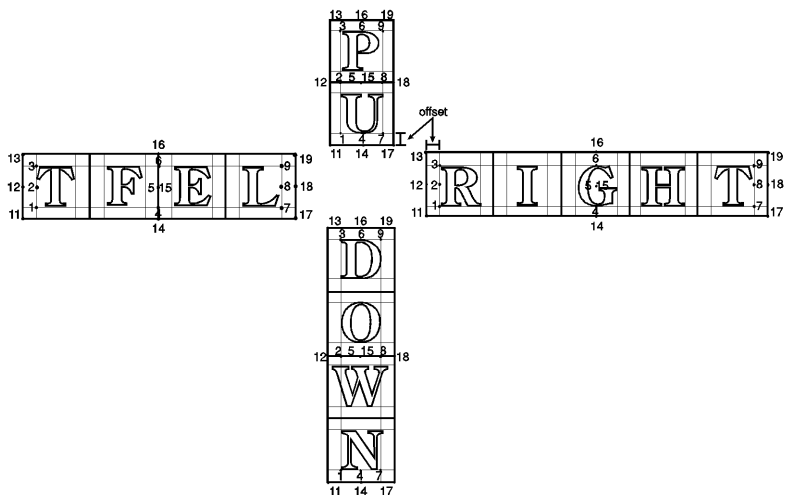

Figure 23-33 Label Origin Positioning

Each time an LO command is sent, the Carriage Return point is updated to the location the pen was in when the LO command was received. The current pen location (but not the Carriage Return point) is updated after each character is drawn and the pen automatically moves to the next character origin. If you want to return a pen to its previous location prior to the next label command, you can send a Carriage Return after the label text but before the label terminator.

When you embed Carriage Return characters in a label, each portion of the label is positioned according to the label origin, just as if they were written as separate label commands.

An LO command remains in effect until another LO command is executed, or the printer is initialized or set to default conditions.

Table 23-34 Example: Using the LO Command

$E_C E$	Reset the printer.
$E_C \%0B$	Enter HP-GL/2 mode.
IN;	Initialize HP-GL/2 mode.
SP1;SC-4000,4000, -5000,5000;	Select pen number 1; specify scaling by assigning (-4000,-5000) to P1 and (4000,5000) to P2.

Table 23-34 Example: Using the LO Command (continued)

SI.17,.26;PA0,500;	Set the absolute character size to .17 cm wide by .26 cm high; move to (0,500).
PD-500,0,0,-500,500,0,0,500;	Set the pen down and draw lines from (0,500) to (-500,0), to (0,-500), to (500,0), and then to (0,500).
DT#;	Define label terminator as “#” character.
CI10;LO4; LBCentered on point#;	Draw a small circle (radius – 10 plu) to represent the label origin point, specify a label origin of 4, and print “Centered on point.”
PU-500,0;CI10; LO18;	Lift the pen and move to (-500,0), draw another small circle, and specify a label origin of 18.
LBLeft center offset#;	Print “Left center offset.”
PU0,-500;CI10; LO13;	Lift the pen, draw another small circle, and specify label origin number 13.
LBRight offset from point#;	Print “Right offset from point.”
PA500,0;CI10;LO3;	Move to (500,0), draw another small circle (dot), and specify label origin number 3.
LBRight hang from point#;	Print the last label, “Right hang from point”.
$E_C\%0A$	Enter the PCL mode.
$E_C E$	Send a reset to end the job and eject the page.

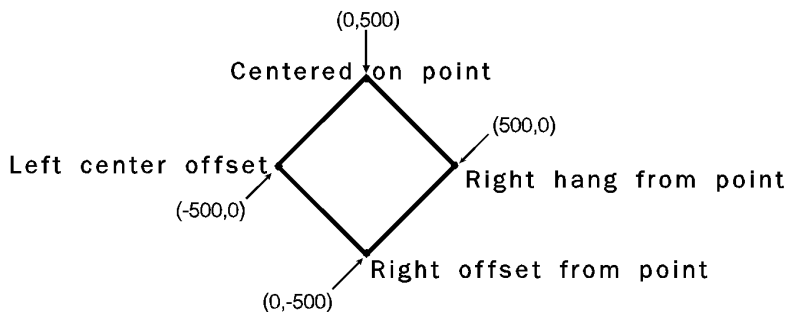

The pen position at the end of the label string depends on whether two successive LB commands concatenate together as though only one label was given. The DV/LO combinations which permit concatenation are:

Table 23-35

Text Path	Label Origin
DV0 (right)	LO's 1,2,3, and 11,12,13,21
DV1 (down)	LO's 3,6,9, and 13,16,19
DV2 (left)	LO's 7,8,9, and 17,18,19
DV3 (up)	LO's 1,4,7, and 11,14,17,21

The following two rules determine where the pen is positioned after a label string is drawn. Rule 1 is for DV/LO combinations which permit concatenation; rule 2 clarifies other DV/LO combinations:

- 1 If a concatenation combination is specified, the pen position is updated to give the normal delta X space between the last character of the first label, and the first character of the second label.

Note

For proportional fonts that use a pair-wise spacing table, the pen position is updated using an average delta X space.

- 2 If a non-concatenation combination is specified, the pen position that existed immediately prior to the LB command is restored.

Table 23-36

Related Commands	Group
CP, Character Plot DV, Define Variable Text Path LB, Label	<i>The Character Group</i>

SA, Select Alternate Font

This command selects the alternate font (already designated by the AD command) for subsequent labeling. Use the SA command to shift from the currently selected standard font to the designated alternate font.

SA [;]

The SA command tells the printer to draw subsequent labeling commands using characters from the alternate symbol set previously designated by the AD command. The SA command is equivalent to using the Shift Out control character (SO, decimal 14) within a label string.

The default designated alternate font uses symbol set 277 (Roman-8). The alternate font remains in effect until an SS command is executed, a Shift In control character (SI, decimal 15) is encountered, or the printer is initialized or set to default conditions.

Table 23-37

Related Commands	Group
AD, Alternate Font Definition DT, Define Label Terminator FI, Select Primary Font FN, Select Secondary Font LB, Label SD, Standard Font Definition SS, Select Standard Font	<i>The Character Group</i>

SB, Scalable or Bitmap Fonts

This command specifies which types of fonts are used for labeling commands. It allows you to restrict font selection to only scalable fonts and the Stick and Arc fonts, disregarding bitmap fonts.

SB [*n*;

or

SB [*:*]

Parameter	Format	Functional Range	Default
n	clamped integer	0 or 1	0

This command is defaulted by the Default Values (DF) command. The SB command takes effect immediately, changing both the standard (primary) and alternate (secondary) fonts to be *scalable only* or *bitmap allowed*, as requested.

- **No Parameter**— Defaults to scalable fonts. Equivalent to SB0.
- **n**— Determines the type of font according to the following parameter values:
 - 0**— Scalable fonts only.
 - 1**— Bitmap fonts allowed.

Note

When (SB1;) is active, *all* fonts obey the same restrictions as bitmapped fonts regarding Character Fill, Orientation, Size, and Slant (see table on next page).

Scalable fonts respond more accurately to some HP-GL/2 commands. The choice of scalable or bitmap fonts can affect the performance of the following HP-GL/2 commands:

Table 23-38 AffectedCommands

Command	Limitation
CF	Bitmapped characters cannot be edged.
DI,DR	Bitmapped characters can be printed only with orthogonal directions (0°, 90°, 180°, or 270°).
SI,SR	Sizes of bitmapped fonts are approximate only.
SL	The Slant command is ignored for bitmapped fonts.
AD,SD,CP,LB	

Note

The FI and FN commands implicitly change the value of SB. For example, if SB = 0 and FI selects a bitmap font, SB is set to 1.

SD, Standard Font Definition

Defines the standard font and its characteristics: symbol set, font spacing, pitch, height, posture, stroke weight, and typeface.

SD *kind,value...[,kind,value;]*

or

SD *[;]*

Parameter	Format	Functional Range	Default
kind	clamped integer	1 to 7	no default
value	clamped real	kind dependent*	kind dependent*

* Refer to the table following the parameter descriptions.

- **No Parameters**— Defaults the standard font characteristics.
- **Kind**— Specifies the characteristic for which you are setting a value.

Table 23-39

Kind	Characteristic	Default Value	Description
1	Symbol Set	277	Roman-8
2	Font Spacing	0	fixed spacing
3	Pitch	9	characters per inch
4	Height	11.5	font point size
5	Posture	upright	upright
6	Stroke Weight	0	medium
7	Typeface	48	Stick (fixed vector)

- **Value**— Defines the properties of the characteristic specified by the *kind* parameter.

Note

When selecting fonts, the different characteristics (symbol set, spacing, pitch, etc.) are prioritized as shown in the table above, with symbol set being the highest priority and typeface being the lowest. The font selection priority is the same for HP-GL/2 as for PCL font selection. For more information about the priority of font characteristics, see the “Font Selection by Characteristic” discussion in Chapter 8.

The following tables list the *kind* parameters with their associated values (note that these tables are also valid for the AD [Alternate Font Definition] command):

Kind 1: Symbol Set

The symbol set characteristic defines the set of characters to be used in the alternate font. For a complete list of symbol set values, refer to Appendix C of the *PCL 5 Comparison Guide*.

Note

Stick font is available only in ASCII, Roman-8, and Roman Extension symbol sets.

Kind 2: Font Spacing

The font spacing characteristic defines whether the spacing is fixed (all characters occupying an equal horizontal space) or proportional (each character occupying a space proportional to its size). Refer to “Using Fonts” in the beginning of this chapter.

Table 23-40 Kind 2: Font Spacing Values

Font Spacing Value	Description
0	fixed spacing (default)
1	proportional spacing

Kind 3: Pitch

The pitch characteristic is a horizontal measurement defining the number of characters-per-inch for fixed-spaced fonts.

Note

When selecting proportional fonts, do not include pitch in the font definition command (SD or AD).

Table 23-41 Kind 3: Pitch Values

Pitch Values	Description
0 to 32 767.9999	characters per inch (default: 9)

Fixed-spaced fonts depend on pitch to determine character size. Proportional fonts ignore pitch. Note that with the SD and AD command you cannot create tall, skinny characters or short, wide characters; the character aspect ratio is preserved unless an SI or SR command overrides it.

Kind 4: Height

For proportional fonts, the height characteristic defines the font point size (the height of the character cell). (Fixed-spaced fonts ignore height; the point size is calculated using the font pitch.) There are approximately 72 points in an inch. Note that with the font definition command (SD or AD), you cannot create tall, skinny characters or short, wide characters; the character aspect ratio is preserved.

Table 23-42 Kind 4: Height Values

Height Values	Description
0 to 32 767.9999	font point size (default: 11.5)

Kind 5: Posture

Posture defines the character's vertical posture. The default posture is upright.

Table 23-43 Kind 5: Posture Values

Posture Values	Description
0	Upright (Default)
1	Italic
2	Alternate Italic

Kind 6: Stroke Weight

The stroke weight characteristic defines the line thickness used in the font's design. The default stroke weight is medium. When relative sizing is in effect, changes in P1 and P2 cause the relative stroke weight to change in relation to the change in P1/P2. If the aspect ratio of the P1/P2 rectangle is maintained as P1 and P2 are moved, a medium stroke weight font still looks "medium" after it is enlarged or reduced.

Note

Available stroke weights are the same as those available within PCL.

Table 23-44 Kind 6: Stroke Weight Values

Stroke WeightValue	Description
-7	Ultra Thin
-6	Extra Thin
-5	Thin
-4	Extra Light
-3	Light
-2	Demi Light
-1	Semi Light
0	Medium, Book or Text
1	Semi Bold
2	Demi Bold
3	Bold
4	Extra Bold
5	Black
6	Extra Black
7	Ultra Black
9999	Stick font only ¹

1. When the Stick font (typeface 48) is selected, the value 9999 renders it using the current pen width.

Kind 7: Typeface

The typeface characteristic selects the font's design style, which gives the font its distinctiveness. Typefaces can only be printed if the printer has access to them; if they are internal fonts, are soft fonts that are downloaded to the printer, or if they reside in a font cartridge or SIMM that is plugged into the printer. PCL 5 LaserJet printers have at least three internal scalable typefaces: Univers (4148), CG Times (4101), and the Stick font (48). (For more information about the printer's internal fonts, refer to Chapter 2 of the *PCL 5 Comparison Guide*.)

Example:Using the SD Command

The following example shows the SD command used to designate a 25-point *Univers Bold* font in the ASCII symbol set (use the Select Standard Font (SS) command to select this font after it is designated):

SD 1,21, 2,1, 4,25, 5,0, 6,3, 7,4148

Symbol Set Font Spacing Height Posture Stroke Weight Typeface

Note that the *pitch* parameter is missing in the above command because the designated font is proportionally spaced.

Table 23-45

Related Commands	Group
AD, Alternate Font Definition	<i>The Character Group</i>
DT, Define Label Terminator	
FI, Select Primary Font	
FN, Select Secondary Font	
LB, Label	
SA, Select Alternate Font	
SI, Absolute Character Size	
SR, Relative Character Size	
SS, Select Standard Font	

SI, Absolute Character Size

This command specifies the size of labeling characters in centimeters. Use SI to establish character size independent of P1 and P2.

SI *width, height[:]*

or

SI *[:]*

Parameter	Format	Functional Range	Default
width	clamped real	-32768 to 32767	dependent*
height	clamped real	-32768 to 32767	dependent*

* Dependent on the current pitch and font height set by the AD or SD commands.

While SI is in effect, with or without specifying parameter values, the size of characters in the currently selected font are not affected by changes in P1 and P2.

- **No Parameters**— Character size is as specified by the SD (Standard Font Definition) and AD (Alternate Font Definition) commands.
- **Width**— Specifies the width of the nominal character in centimeters. A negative width parameter mirrors labels in the right-to-left direction.

Note

Changing character size also changes the width of line used to draw Stick font characters.

- **Height**— Specifies the cap height in centimeters. A negative height parameter mirrors labels in the top-to-bottom direction.

Note that in most languages the width of a letter is typically less than the height. If you set your characters to have a different 'aspect ratio', they may look odd to your readers.

An SI command remains in effect until another SI command is executed, an SR command is executed, or the printer is initialized or set to default conditions.

Notes

If the (SB1;) command is in effect, an SI command may not be executed accurately. Labels are rendered using the bitmap font that most closely approximates the character height or width specified by SI (character size is determined by height for proportional fonts and by width for fixed-spaced fonts).

When (SB1;) is in effect, characters cannot be mirrored with negative SI parameters.

Example:Using the SI Command

The following example demonstrates the SI command using both the default Stick typeface and the Univers typeface. The samples on the left were printed using the Stick font, first using the default (11.5-point) and then specifying an absolute character size of 1 cm wide by 1.5 cm high. On the right, a Univers font was used, first at 12-point and scaled to 1 cm by 1.5 cm using the SI command.

Table 23-46 Example: Using the SI Command

E _C E	Reset the printer.
E _C %0B	Enter HP-GL/2 mode.
IN;	Initialize HP-GL/2 mode.
SP1;	Select pen number 1. Even though there is no physical pen, the SP command must be used to enable printing.
PA700,3000;	Enter absolute plotting mode and move to (700,3000).
DT#;	Define the label terminator as the “#” character.
LBPrint#;	Print the word “Print” in the default font.
PA700,2000;SI1,1.5; LBPrint#;	Move to (700,2000), specify an absolute character size of 1cm wide by 1.5 cm high, and print the word “Print.”
SI;	Send SI with no parameters to return to the default size.
SD1,21,2,1,4,12, 5,0,6,0,7,4148;SS;	Designate a 12-point Univers font and select it.

Table 23-46 Example: Using the SI Command (continued)

PA4000,3000; LBPrint#;	Move to (4000,3000) and print "Print" in 12-point Univers.
PA4000,2000; SI1,1.5;LBPrint#;	Move the pen to (4000,2000) and specify a character size of 1 cm by 1.5 cm, then print "Print".
E _C %0A	Enter the PCL mode.
E _C E	Send a reset to end the job and eject the page.

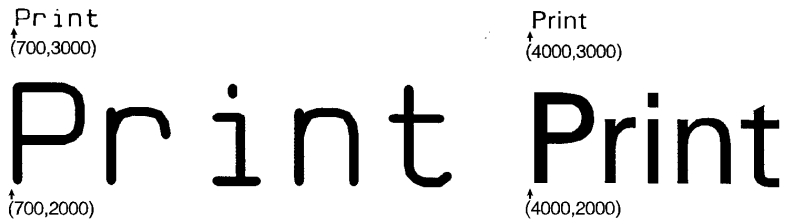

Figure 23-34

The following are examples of negative parameters producing mirror-images of labels. A negative width parameter mirrors labels in the right-to-left direction.

SI-.6,.9;LBPrint#;



Figure 23-35

A negative height parameter mirrors labels in the top-to-bottom direction.

SI.6,-.9;LBPrint#;



Figure 23-36

Negative width and height parameters together mirror labels in both directions, causing the label to appear to be rotated 180 degrees.

SI-.6,-.9;LBPrint#;



Figure 23-37

Table 23-47

Related Commands	Group
AD, Alternate Font Definition	<i>The Character Group</i>
CP, Character Plot	
DI, Absolute Direction	
DR, Relative Direction	
LB, Label	
SB, Scalable or Bitmap Fonts	
SD, Standard Font Definition	
SR, Relative Character Size	

SL, Character Slant

This command specifies the slant at which labels are drawn. Use SL to create slanted text for emphasis, or to re-establish upright labeling after an SL command with parameters has been in effect. (Note that the SL command has no effect when an (SB1;) command is in effect.)

SL *tangent of angle*[:]

or

SL [:]

Table 23-48

Parameter	Format	Functional Range	Default
tangent of angle	clamped real	-32768 to 32767	0

The printer interprets the parameters as follows:

- **No Parameter**– Defaults the slant to zero (no slant). Equivalent to (SL0).
- **Tangent of Angle**– Interpreted as an angle θ from vertical. The base of the character always stays on the horizontal as shown in the following illustration.

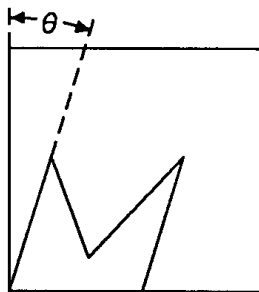

Positive Slant

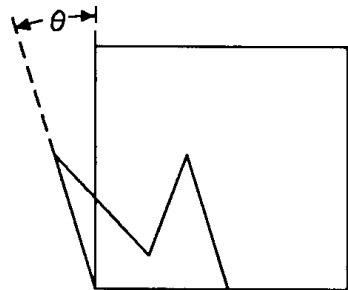

Negative Slant

Figure 23-38 Character Slant

The SL command only affects each character relative to an imaginary line beside the label. The direction or placement of the label on the drawing does not affect the SL command; neither do the settings of P1 and P2. The DI and DR commands, however, do affect the slant direction, since the base of a character always stays on the baseline of the label.

You can specify the actual tangent value, or you can use the TAN function available in most computer languages.

An SL command remains in effect until another SL command is executed, or the printer is initialized or set to default conditions.

Example:Using the SL Command

The following example illustrates the Slant command using a tangent value listed in the previous table.

Note

Many languages require that tangents be calculated in radians. Consult your programming language documentation if you are not familiar with your language's tangent function.

Table 23-49 Example: Using the SL Command

<code>E_CE</code>	Reset the printer.
<code>E_C%0B</code>	Enter HP-GL/2 mode.
<code>IN;</code>	Initialize HP-GL/2 mode.
<code>SP1;</code>	Select pen number 1. Even though there is no physical pen, the SP command must be used to enable printing.
<code>SD1,21,2,1,4,25, 5,0,6,0,7,4101;</code>	Designate the 25-point CG Times font as the standard (primary) font.
<code>SL.7,1;PA1000,1000;</code>	Set the absolute character size to .7 cm wide by 1 cm high; establish absolute plotting and move to (1000,1000).
<code>DT#,1;</code>	Specify a label terminator (#).
<code>SL.36;LBSlant#;</code>	Set the slant angle for 20° from vertical (forward slant), and print "Slant."

Table 23-49 Example: Using the SL Command (continued)

PA1000,300; SL-.36;LBSlant#;	Move to (1000,300), change the slant angle to -20° from upright and print “Slant.”
E _C %0A	Enter the PCL mode.
E _C E	Send a reset to end the job and eject the page.

Slant
(1000,1000)

Slant
(1000,300)

Figure 23-39

Table 23-50

Related Commands	Group
SB, Scalable or Bitmap Fonts DI, Absolute Direction DR, Relative Direction LB, Label	<i>The Character Group</i>

SR, Relative Character Size

This command specifies the size of characters as a percentage of the distance between P1 and P2. Use SR to establish relative character size so that if the P1/P2 distance changes, the character size adjusts to occupy the same relative amount of space.

SR *width height[:]*

or

SR *[:]*

Parameter	Format	Functional Range	Default
width	clamped real	-32768 to 32767	0.75% of P2X–P1X
height	clamped real	-32768 to 32767	1.5% of P2Y–P1Y

While the SR command is in effect (with or without parameters), changes in P1 and P2 affect the size of characters in the currently selected font.

- **No Parameters**— Defaults the relative character width to 0.75% of the distance (P2X – P1X) and the height to 1.5% of the distance (P2Y – P1Y).
- **Width**— Sets the character width to the specified percentage of the distance between the X-coordinates of P1 and P2. A negative width parameter mirrors labels in the right-to-left direction.

Note

Changing character size also changes the apparent stroke weight of labels; the printer adjusts characters relative to changes in P1/P2. As long as the aspect ratio remains the same with changes in P1/P2, characters will have the same appearance relative to the new P1/P2 rectangle.

- **Height**— Sets the character height to the specified percentage of the distance between the Y-coordinates of P1 and P2. A negative height parameter mirrors labels in the top-to-bottom direction.

The character size you specify with SR is a percentage of (P2X – P1X) and (P2Y – P1Y). The printer calculates the actual character width and height from the specified parameters as follows:

$$\text{actual width} = (\text{width parameter}/100) \times (P2_X - P1_X)$$

$$\text{actual height} = (\text{height parameter}/100) \times (P2_Y - P1_Y)$$

For example, suppose P1 and P2 are located at (–6956,–4388) and (6956,4388), respectively. If you establish relative sizing and specify a width of 2 and a height of 3.5, the printer determines the actual character size as follows:

$$\text{width} = || (2/100) \times (6956 - (-6956)) = 278.24 \text{ plu or } 0.695 \text{ cm}$$

$$\text{height} = (3.5/100) \times (4388 - (-4388)) = 307.16 \text{ plu or } 0.768 \text{ cm}$$

If you changed P1 and P2 settings to (100,100) and (5000,5000), but did not change the SR parameters, the character size would change as follows:

$$\text{width} = (2/100) \times (5000 - 100) = || 98 \text{ plu or } 0.245 \text{ cm}$$

$$\text{height} = (3.5/100) \times (5000 - 100) = 171.5 \text{ plu or } 0.429 \text{ cm}$$

Note that in most languages the width of a letter is typically less than the height. If you set your characters to have a different “aspect ratio”, they may look odd to your readers.

Note

Either negative SR parameters or switching the relative position of P1 and P2 produces mirror-images of labels. When P1 is in the lower left and P2 is in the upper right, the SR command gives the same mirroring results as the SI command. However, if you move P1 to the right of P2, characters are mirrored right-to-left; when you move P1 above P2, characters are mirrored top-to-bottom. When both of these situations occur (using negative parameters in the SR command with an unusual P1/P2 position) double mirroring may result in either direction, in which case the two inversions cancel, and lettering appears normal.

An SR command remains in effect until another SR command is executed, an SI command is executed, or the printer is initialized or set to default conditions.

Example:Using the SR Command

The following example first shows a label with a character size relative to P1 and P2 (SR). Next, the locations of P1 and P2 are changed; then, the character size percentages are specified. Notice that the new character size has equal parameters of 2.5; because the P1/P2 area is square, the resulting characters are square.

Table 23-51 Example: Using the SR Command

E _C E	Reset the printer.
E _C %0B	Enter HP-GL/2 mode.
IN;	Initialize HP-GL/2 mode.
SP1;	Select pen number 1. Even though there is no physical pen, the SP command must be used to enable printing.
IP-6956,-4388, 6956,4388;	Move P1 to (-6956,-4388) and P2 to (6956,4388).
DT@;	Specify "@" as the label terminator.
SR;PA0,2700; LBRELATIVE LABEL SIZE@;	Default the character size as a percentage of the P1/P2 rectangle, move the pen to (0,2700), and print "RELATIVE LABEL SIZE."
IP0,0,5500,5500; PA0,2000;	Move P1 to (0,0) and P2 to (5500,5500), then move the pen to (0,2000).
LBNEW P1 AND P2 CHANGE LABEL SIZE@;	Print "NEW P1 AND P2 CHANGE LABEL SIZE."
PA0,1000;SR2.5,2.5;	Move to (0,1000) and set the character size to 2.5% by 2.5% of the P1/P2 rectangle.
LBNEW SRm INSTRUCTION@;CP ;	Print "NEW SR INSTRUCTION" and send CP for Carriage Return/Line Feed.
LBCHANGES LABEL SIZE@;	Print "CHANGES LABEL SIZE."
E _C %0A	Enter the PCL mode.
E _C E	Send a reset to end the job and eject the page.

↑
(0,2700)
RELATIVE LABEL SIZE

↑
(0,2000)
NEW P1 AND P2 CHANGE LABEL SIZE

↙
(0,1000)
NEW SR INSTRUCTION
CHANGES LABEL SIZE

Figure 23-40

Table 23-52

Related Commands	Group
CP, Character Plot	<i>The Character Group</i>
SB, Scalable or Bitmap Fonts	
DI, Absolute Direction	
DR, Relative Direction	
IP, Input P1 and P2	
IR, Input Relative P1 and P2	
SI, Absolute Character Size	

SS, Select Standard Font

This command selects the standard font (already designated by the Standard Font Definition (SD) command) for subsequent labeling. Use the SS command to shift from the currently selected alternate font to the designated standard font.

SS [;]

The SS command tells the printer to print subsequent labeling commands using characters from the standard symbol set designated by the SD command. The SS command is equivalent to using the Shift In control character (SI, ASCII decimal code 15) within a label string.

The default designated standard font is the Stick font, and uses symbol set 277 (Roman-8). This font is in effect when the printer is initialized or set to default conditions. The SS command remains in effect until an SA command is executed.

Table 23-53

Related Commands	Group
AD, Alternate Font Definition DT, Define Label Terminator FI, Select Primary Font FN, Select Secondary Font LB, Label SA, Select Alternate Symbol set SD, Standard Font Definition	<i>The Character Group</i>

TD, Transparent Data

This command specifies whether control characters perform their associated function or print as characters when labeling. Use the TD command to print characters that function only as control characters in normal mode.

TD *mode*[:]

or

TD [:]

Table 23-54

Parameter	Format	Functional Range	Default
mode	clamped integer	0 or 1	0 (normal)

The printer interprets the parameters as follows:

- **No Parameters**– Defaults the labeling mode to normal. Equivalent to (TD0).
- **Mode**– Selects the normal or transparent data mode for labeling.
- **0 — Normal.**Control codes with an associated functionality perform their function and do not print. Refer to the symbol set tables in Appendix B of the *PCL 5 Comparison Guide*.
- **1 — Transparent.**All characters print and perform no other function (except the currently defined label terminator, which terminates the label). The printer prints a space for non-printing or undefined characters.

Transparent data mode must be enabled to access printable characters which have character codes with an associated functionality in normal mode. For example, the left arrow in the PC-8 symbol set has a character code of 27. In normal mode, a character code of 27 is interpreted as an escape character (E_C); in transparent data mode, a character code of 27 prints a left arrow.

Table 23-55

Related Commands	Group
AD, Alternate Font Definition DT, Define Label Terminator LB, Label SA, Select Alternate Font SD, Standard Font Definition SS, Select Standard Font	<i>The Character Group</i>

24 Programming Hints

Introduction

This chapter provides information for use during the development of PCL software.

PCL Command Parsing

A job stream may contain commands that are device specific. If these commands are not supported by the PCL device, they are ignored. For example, a Duplex Print command has no effect on the HP LaserJet III, IIIP or LaserJet 4 printers, since these are non-duplexing printers. However, on printers which support duplex printing (such as the HP LaserJet IIID and LaserJet IIISi), the job is printed in duplex mode.

Job Control

Printer Reset

Hewlett-Packard strongly recommends the use of both the $\text{E}_{\text{C}}\text{E}$ command and the $\text{E}_{\text{C}}\% - 12345\text{X}$ command (Universal Exit Language/Start of PJJ — also referred to as the **UEL Command**) at the beginning and end of each job. (The order of these commands is critical; refer to Table 24-1 for an example.) This allows the next job to start with the default settings as a known base. Starting with the default environment at the beginning of each print job eliminates the need to set every feature each time a job is run.

Table 24-1 Structure of a Typical Job

$\text{E}_{\text{C}}\% - 12345\text{X}$	UEL Command (exit language).
$\text{E}_{\text{C}}\text{E}$	Printer Reset Command.
Preamble	Job Control Commands.
Page 1	Page Control Commands.
	Data
:	:
Page n	Page Control ¹ Commands.
	Data.
$\text{E}_{\text{C}}\text{E}$	Printer Reset Command.
$\text{E}_{\text{C}}\% - 12345\text{X}$	UEL Command (exit language).

1. If a number of consecutive pages within a job have the same format (such as margins, VMI, HMI, etc.), the associated page control commands only need to be sent once for that group of pages.

Note

The UEL Command ($\text{E}_{\text{C}}\% - 12345\text{X}$) has the same effect as the $\text{E}_{\text{C}}\text{E}$ command, and also enters PJJ Mode of operation for printers that support PJJ. The $\text{E}_{\text{C}}\text{E}$ command should be included to ensure backward compatibility (the UEL command is ignored if received by a printer that does not support PJJ).

Do not perform a printer reset *within* a job.

PCL Page Control 1

Paper Source

The primary use for the paper source command is to allow access to “locked out” (secured) paper trays.

Page Size

This command specifies the exact size of the page (media) to be used.

Text Area/Margins

Avoid setting the top margin or text length to values outside of the printable area. This may cause data loss.

Top Margin and Text Length commands use the current line spacing (the last VMI or lpi commands).

Specifying the text length establishes the bottom margin.

When using both the Top Margin and Text Length commands, send the Top Margin command before the Text Length command.

To address the entire logical page set the top margin to 0, set perforation skip mode OFF, and position the cursor to the desired location.

The user default VMI is selectable from the control panel printing menu, using the FORM menu item (refer to the printer *User's Manual*).

HMI

When a font is selected, HMI is set automatically to correspond to the pitch of the selected font if fixed-pitch, or the recommended (default) word space if proportional. Therefore, when using a non-standard HMI value, the value must be re-specified following each font selection.

PCL Cursor Positioning

Horizontal (decipoint, dot and column) positioning ignores margins, and therefore can be used to move the cursor anywhere along the present line.

When performing cursor positioning with decipoints, PCL Units, or rows and columns, do not use margins. Margins are intended for print and space (i.e., CR, LF, FF) applications.

Vertical (decipoint, dot and row) positioning allows the cursor to be moved into the perforation region.

The top margin is the reference point for *absolute* vertical positioning. The left edge of the logical page is the reference point for *absolute* horizontal positioning.

The current active position (CAP) is the reference point for *relative* vertical and horizontal positioning.

Refer to Chapter 6 for more information on cursor positioning.

Fonts

Character spacing information for proportionally-spaced fonts can be obtained in several ways. The preferred method is using Hewlett-Packard's AutoFont Support. AutoFont Support is a standard method for identifying font information. It provides basic font information including spacing information in AutoFont format, in a file with a TFM (tagged font metric) extension. AutoFont support files can be created for any soft font using Hewlett-Packard's **Type Director 2.0** (and later). AutoFont support for Hewlett-Packard's newer font cartridge products are furnished as TFM files on a disk.

Character spacing information for proportionally spaced fonts is available from Hewlett-Packard. Spacing information can be obtained from Hewlett-Packard's Type Director 2.0 typeface and font management program.

Character spacing information can also be obtained from listings generated through the operation of the spacing feature available from Hewlett-Packard's FontLoad Utility, HP product number 33407B.

Since line spacing is independent of font height, line spacing may require adjustment following font selection to ensure proper vertical alignment of text.

To ensure compatibility with future products, select fonts by specifying **all** of the font characteristics. If all of the characteristics are not designated, the primary and secondary font tables in the printer may not contain the correct information to select the requested font from those available in the printer.

The shortcut method of font selection is not recommended (as documented in some previous font product literature) and may not result in the desired font change. This is due to the increased number of available fonts in the printer.

The transparent print data command is required to access printable characters with character codes in the decimal range of 0, 7-15, and 27 in the PC symbol sets.

All information about the design of a font, as well as the design of its characters, can be found in the font and character descriptors.

A Space control code is executed when an attempt is made to print a non-existent character.

Using an ID number which has not been associated with a font results in no font change.

Font designers should not define the space character. Use the printer's Space control code should be used for character spacing. Defining the space character in the font results in a significant reduction in performance and inhibits the HMI command with proportional fonts.

Note

Refer to "HP-GL/2 Vector Graphics" later in the chapter for hints on using HP-GL/2 text.

PCL Raster Graphics

To minimize I/O transmission time and conserve memory, avoid sending unnecessary raster data to the printer that represents white space. This is accomplished using the raster compression modes and raster reduction techniques available with the raster picture area.

Set resolution prior to the start raster graphics command. Once the start raster command is received, the resolution cannot be set until after a subsequent end raster graphics command.

Set presentation mode prior to the Start Raster Graphics command. Once the start raster command is received, the presentation mode cannot be set until after a subsequent End Raster Graphics Command.

Some applications and I/O drivers insert carriage returns or line feeds into the data stream sent to the printer. This modification of the data stream must be suppressed for correct printer operation.

The most efficient way to draw lines (horizontal and vertical) is using graphics rules (black-fill rectangular areas). The most efficient way to draw diagonal lines is using HP-GL/2 vector graphics.

Macros

When a macro ID is specified for which no macro has been defined, the macro invocation, macro deletion, and make macro permanent or temporary commands are ignored.

The macro enabled for auto macro overlay is executed on each page, until the macro is disabled or deleted, a reset occurs (“E” “CE” “UEL” or control panel), or the page length, page size or orientation is changed.

When the modified print environment is restored (upon exiting a called or overlaid macro), if the page length, page size, or the orientation has changed, or the primary or secondary font has been deleted, the following occurs:

- 1 If the original page length or page size is different than the current page length and page size, the current page is closed and printed, the page length and page size are changed to their original value, and the cursor is positioned at the left edge of the logical page at the top margin on the following page.
- 2 If the primary or secondary font is deleted, a new primary or secondary font is automatically selected from the remaining fonts using the current font characteristics.

HP-GL/2 is supported within a macro on some printers (refer to the “PCL Feature Support Matrix” in Chapter 1 of the *PCL 5 Comparison Guide*. HP-GL/2 implementation within macros matches that of PCL.

Macro problems can often be avoided by first ensuring that the data formats outside the macro environment.

HP-GL/2 Vector Graphics

There are different approaches (commands) and techniques that can be used to create an HP-GL/2 image. To assist in determining the most efficient approach to creating an image, several points are identified below:

- When using line caps and joins:
 - Most efficient - Round join with butt cap
 - Least efficient - Round join with triangular cap
- When using text, if you want the character to be printed at the same location as it would in PCL, use label origin position 21 (see “Label Origin” command, in Chapter 23).
- Default pen widths (5 dots wide or less) produce the highest speed.
- Hewlett-Packard recommends using polygon mode when the number of points in a polygon is 1000 or less.
- The Polyline Encoded command can reduce data by 60% to 70%.
- When drawing shapes, use a command that was designed to draw that shape. For example, to draw a rectangle, use the ER command to produce it, instead of stroking the shape line by line.
- When drawing arcs or circles, use the Bezier commands to eliminate the need to compute the chord angle, thus resulting in better quality and efficiency.
- To Scale text, use the HP-GL/2 font selection commands, such as SD or AD, that use Intellifont or TrueType to scale the text. Scaling text in HP-GL/2, using the SR or SI commands, is much less efficient.
- Font transformations in HP-GL/2, such as mirroring, scaling, slanting, rotating, and outlining are very processing intensive. An “ERROR 21” (print overrun) may occur. The error can be controlled by using the HP LaserJet “Page Protection” feature.

Performance

PCL Commands

Since PCL printers are command driven devices and each command takes a finite amount of time to process, pages composed of a large number of commands may not print at maximum speed. Most commands can be used frequently on a page without adversely affecting the printer's performance; however, certain commands take more time to process and therefore, if used frequently on a page, may decrease printer performance. An excessive number of font selections per page (selection using font characteristic commands or selection by ID number) may decrease printer performance.

Print Data

There is a limit on the amount of data, as well as the number of commands, that the printer can process per page at maximum speed.

Print Overrun

As data is received by the printer, it is processed and stored in an intermediate format. The intermediate data is later processed and printed. During the physical printing of a page, the page moves through the printer at a constant speed. Thus, some pages cannot be printed because the page's intermediate data cannot be processed fast enough to keep up with the physical speed of the page as it moves through the printer. When this condition occurs, an error number "21" (ERROR 21 - print overrun) is displayed on the printer's control panel. A page causing this error can be printed by setting the printer's page protection feature to ON (see next section).

Page Protection

If enabled, page protection reserves an amount of memory for the page image process, allowing the printer to create the entire page image (in memory) before physically moving the paper through the printer.

Note

The page protection feature is available only with additional optional memory on many HP LaserJet printers. (One exception is the LaserJet 4 printer, which supports page protection for letter-size paper **in 300 dpi mode** with the standard 2 Mbytes memory.) Refer to the appropriate *User's Manual* for specific memory requirements.

The Page Protection feature can be used to prevent possible ERROR 21 conditions. ERROR 21 is reported when data is too complex for the printer to process concurrent with actual physical printing. A frequent cause of ERROR 21 when printing graphics is that the program sends commands to print a single point many times during the page run.

Page protection can be set for letter, A4, or legal sized pages. Set page protection for the page size most often used.

I/O

The Parallel (Centronics) I/O has higher throughput than the RS-232C serial I/O. While text processing may not benefit from a faster I/O, raster graphics processing and soft font downloads will usually benefit from increased I/O throughput.

Troubleshooting Commands

End-of-Line Wrap

The End-of-Line Wrap command defines the action that occurs when a line of text reaches the right margin.

$E_C \& s \# C$

=0 - Enables End-of-Line Wrap
1 - Disables End-of-Line Wrap

When end-of-line wrap is enabled, a character or space that moves the cursor to the right of the right margin executes a CR-LF (prior to the printing of the character or space).

When end-of-line wrap is disabled, a character or space that would move the cursor to the right of the right margin may be clipped (refer to Chapter 2). When a character is clipped, the cursor is set to the right margin.

The primary use of this command is with display functions mode.

The factory default is end-of-line wrap disabled.

Example

To enable end-of-line wrap mode, send:

$E_C \& s 0 C$

Display Functions Mode

The Display Functions Mode command allows all escape sequences and control codes to be printed instead of being executed.

$E_C Y$ - Enables Display Functions Mode

$E_C Z$ - Disables Display Functions Mode

When the printer is in display functions mode, all control codes and escape sequences are printed and not executed, with the following exceptions:

- CR is printed and executed as CR-LF.
- $E_C Z$ is printed and executed.

Display functions mode instructs the printer to display rather than execute the data it receives. The data is printed using the current text area and selected font.

Note

To print characters 0, 7-15, and 27 in fonts which have printable characters in these positions (such as PC-8), the printer must be in Display Function Mode, or be given a Transparent Print command.

Example

To enable display functions mode, send:

$E_C s0C$	Enables end-of-line wrap to prevent data truncation.
$E_C Y$	Enable Display Functions Mode.
	●
	●
	●
	<i>Data sent to the printer.</i>
	●
	●
	●
$E_C Z$	Disable Display Functions Mode.

Note

Most symbol sets do not have printable characters defined in the control code decimal range 0 to 31 and 128 to 159. If a printable character is not defined, a Space control code is printed while in display functions mode. The PC symbol sets do have printable characters defined in this range.

Auto Continue Mode

Automatic error clearing (refer to the printer *User's Manual* for a list of clearable errors) can be achieved by setting Auto-Continue Mode to ON, using the Operator Control Panel configuration menu. When "Auto-Cont" is set to ON, the device displays a message for 10 seconds, and then attempts to continue printing the job. When "Auto-Cont" mode is set to OFF, all errors cause the device to stop printing.

Common Errors

20 ERROR

This error occurs when the printer runs out of memory during a font download, macro creation, raster graphic download, or page composition. To alleviate this error, the quantity of data sent to the printer must be reduced. This can be accomplished by eliminating unnecessary fonts or macros, reducing the raster graphics white space sent to the printer, or selecting a lower resolution for the raster graphics. An alternative solution is to install additional memory. Additional memory is available from your Hewlett-Packard Sales Representative or authorized dealer.

21 ERROR

This error results when a page is too complex to print. The error can be corrected by reducing the complexity of the page, or by enabling Page Protection mode from the control panel. (Refer to the "Print Overrun" section described earlier in this chapter for additional information.)

22 ERROR

This error indicates an I/O protocol problem between the printer and the host system. Make sure the printer and the host system protocol (hardware handshake or Xon/Xoff handshake) correspond and that your cable is correct for your host/printer configuration.

40 ERROR

An error occurred while transferring data from the computer to the printer. This error occurs if the computer is turned ON and OFF while the printer is on-line, or if the printer's baud rate, parity, or data character size are not the same as the computer's. To clear the error message press **[[CONTINUE/RESET]]** (refer to the printer *User's Manual*). Make sure the printer is set to the same baud rate as the computer, and that your host I/O has been configured for your printer. If the error continues, call your HP Service Representative.

For additional printer errors, refer to the printer *User's Manual*.

Customer Support

Support services are available to help you in case you have a question about your HP LaserJet printer. Following are some places to turn for this support.

Help From Your Organization

If your organization has many HP printers, the best source of assistance may be within your own company. Many organizations designate central support personnel to help when you have any problems with your computer system or when you need consumable items such as toner cartridges or paper. These support personnel, in turn, can call special resources within HP when necessary.

Help From Your Dealer

If you purchased your printer from an HP dealer or system vendor, your dealer is the best source of assistance. Your salesperson should be familiar with your needs, equipment, configuration and software and should be able to provide you with the information you need. Your dealer can also access special support resources and programs within HP. Contact your dealer for details on available support options.

Help from HP

The CompuServe HP Forum

The HP Forum on CompuServe is a fast and easy way to get drivers and updated application notes for HP LaserJet printers. As soon as printer drivers and notes are available, they are uploaded to HP Forum for instant access by CompuServe members.

If you are not a member of CompuServe, but would like to join, call CompuServe at 1-800-848-8199 (operator #51) and take advantage of the Free Introductory Membership, which includes:

- A \$15 introductory usage credit to CompuServe.
- A private User ID number and Password.
- A complimentary subscription to CompuServe's monthly publication, *CompuServe Magazine*.

HP Distribution

Software drivers and application notes are also available through HP Distribution by calling at 303-353-7650 (materials are mailed at no charge).

HP FIRST Faxback support

Hewlett-Packard has installed a "faxback" service called HP FIRST (Fax Information Retrieval Support Technology). A wealth of information on HP peripherals, including the full line of HP LaserJet printers, is available to anyone with access to a group 3 fax machine. The phone number for the HP FIRST service is:

208-344-4809

HP's Personal Peripherals Assist Line

If your organization's support personnel or your dealer are unable to answer your question, Hewlett-Packard has a Personal Peripherals Assist Line available to you. It is available from 7 AM to 6 PM (Mountain Standard Time), Monday, Tuesday, Thursday, and Friday, and 7 AM to 4 PM (MST) Wednesday.

(208) 323-2551

Before you call the Personal Peripherals Assist Line, do the following:

- 1 Check the "Troubleshooting Checklist" section of your printer *User's Manual*.
- 2 Use the printer's control panel to print self-test, if possible.
- 3 Check with you software vendor for help if you suspect a software problem.

When you call the Personal Peripherals Assist Line, please have the following information available to help us answer your questions:

- Identify which computer you are using.
- Identify any special equipment or software you are using (for example, spoolers, networks, switch boxes, modems or special software drivers).
- Identify the cable you are using and who sold it to you.
- Identify any special interface, I/O, or RAM boards installed in your printer.
- Identify the software names and versions you are currently using.

Glossary

Auto-Continue

Auto-Continue mode can be configured using the printer's control panel (refer to the printer *User's Manual*).

Aspect Ratio

The ratio of the width to height of an image.

Baud Rate

Baud rate is the rate at which information is transferred between the computer and the printer. To communicate properly, the computer and printer must both be configured to the same baud rate.

Bound and Unbound Fonts

A bound font is a font which contains a pre-specified set of symbols, such as Roman-8, PC-8, etc. An unbound font (or more accurately, unbound *typeface*) has the capacity to be bound to a set of symbols selected from a complementary **Symbol Index** (such as HP's Master Symbol List - **MSL**, or the **Unicode** symbol list). See Chapter 10, "User-Defined Symbol Set" for more information.

CAP (Current Active Position)

The PCL cursor position refers to the **Current Active Position (CAP)**, like the blinking underline character (cursor) used on most computers. This "cursor" identifies the current position on the page; the pointer, where a printing command begins laying out page data. The cursor can be moved anywhere within the logical page using a combination of horizontal and vertical cursor positioning commands and control codes (see Chapter 6, *Cursor Positioning*).

Centronics I/O

An industry standard parallel input/output (I/O) interface. (Also see *Parallel I/O*.)

Character Descriptor

The character descriptor is a block of data that identifies the characteristics for a specific character, such as its position, and the cursor position after printing. The character data which follows, defines the shape of the character. Chapter 11 describes the character definition and descriptor formats for PCL bitmap fonts, as well as Intellifont and TrueType scalable fonts.

Column

The width of a column is defined by the current Horizontal Motion Index (HMI).

Compression (raster graphics)

Raster graphics compression methods reduce the amount of code needed to generate a raster graphic image and improve the efficiency with which the image is printed. The Set Compression Method command allows you to code raster data in one of four compressed formats: Run-length encoding, tagged imaged file format (TIFF) rev. 4.0, delta row compression, and adaptive compression. These techniques are described in detail under "Set Compression Method Command" in Chapter 15.

Configuration

Configuration is the process of changing certain printer settings to allow a computer to communicate properly with the printer. For example, interface selection is part of printer configuration. The printer is configured using the control panel configuration menu.

Configuration Menu

Identifies printer features which are set from the printer's Operator Control Panel. Configuration menu selections include such features as Auto-Continue, I/O configuration, and Resolution Enhancement setting. The configuration menu includes features which are not part of the print environment (features which can not be selected with printer commands).

Control Code

A control code is a type of PCL language command that initiates a printer function, for example CR (Carriage Return), LF (Line Feed), and FF (Form Feed).

Control Panel

The combination of keys, LEDs, and a display that allows an operator to communicate with a device and allows the device to communicate with an operator.

Current Active Position (CAP)

See CAP.

Cursor

Although the printer does not actually have a cursor, the cursor position refers to the currently active printing position (like the blinking underline character used on most computer terminals). The cursor can be moved anywhere within the logical page using a combination of horizontal and vertical cursor positioning commands and control codes.

Decipoint

A decipoint is a unit of measurement that equals 1/720th of an inch.

Default

A value used instead of a programmatically selected value. A factory default is a value programmed into the device at the factory; this value is stored in read-only memory (ROM) and cannot be changed by a user or operator. A user default is a default which is selectable via the control panel.

Dot

The dot is the smallest printable unit. On HP LaserJet printers, one dot can equal either 1/300th or 1/600 inch. The number of dots printed per inch is referred to as the printer's resolution.

Downloading

The process of transferring soft fonts, macros, or raster data from a host computer to the printer's user memory is called downloading.

DTR Polarity

The configuration of DTR polarity determines whether pin 20, on the serial interface connector, is high or low when the printer is ready. If DTR polarity is HI, pin 20 is high when the printer is ready. If DTR polarity is LO, pin 20 is low when the printer is ready.

Escape Character

The first character of a PCL command (or "escape sequence") is identified by the ? symbol, (ASCII decimal code 27). This character is a control code used specifically by the printer to identify a string of characters as a printer command. As the printer monitors incoming data from a computer, it is "looking" for this character. When this character appears, the printer reads it and its associated characters as a command to be performed, and not data to be printed.

Escape Sequence (or "PCL Command")

PCL escape sequences consist of two or more characters. The first character is always the escape character, which is identified by the ? symbol. This character is a control code used specifically by the printer to identify a string of characters as a printer command. As the printer monitors incoming data from a computer, it is "looking" for this character. When this character appears, the printer reads it and its associated characters as a command to be performed, and not as data to be printed. (Also see *PCL commands*.)

Factory Default

These are the settings that are programmed into the printer at the factory. These settings are in use unless you override them using either the control panel or by sending printer commands.

Factory Default Environment

A factory default is a setting programmed into the printer at the factory. The group of all the printer's factory settings is referred to as the factory default environment. The factory default symbol set is selectable from the control panel configuration menu (refer to the printer *User's Manual*).

Font

A font is a set of characters that have similar characteristics. A font has an assigned name, typeface, and is further described by its spacing, height, pitch, style, stroke weight, symbol set, and orientation. For example, the name of the font used for this text is Helvetica; its height is 10 point, its style is upright, and its stroke weight is medium.

Font Cartridge

A removable media containing multiple fonts. When a cartridge is plugged into the printer, the printer has access to the fonts contained in the cartridge.

Font Header

The font header and character definitions contain all the information needed to format a font for use in the HP LaserJet printers.

Every PCL font header begins with a font descriptor, which identifies the basic characteristics common to all characters of a font, such as: font type, baseline position, character cell width and height, character orientation, symbol set, etc. Chapter 11 describes the font header and character definition formats for PCL bitmap fonts, as well as Intellifont and TrueType scalable fonts.

Height

The height of a font is the measurement of the body of the type in points. A PCL point is 1/72nd inch. The body of the type is slightly greater than the distance from the bottom of a descender (such as the tail of lower-case "p") to the top of an unaccented capital letter.

Horizontal Motion Index (HMI)

HMI defines the distance between columns in 1/120 inch increments. When fixed pitch fonts are selected, all printable characters including the space and backspace characters are affected by HMI. When proportional fonts are selected, the HMI affects only the space character.

HMI is defaulted when font orientation, symbol set, pitch, spacing or height is specified and when switching between primary and secondary fonts with Shift In and Shift Out.

The default HMI is equal to the pitch value in the font header. The factory default font's HMI is 12 (which is $12/120 = 1/10$ inch per character or 10 characters per inch).

HP-GL/2

PCL 5 printers provide the ability to print vector graphics using the HP-GL/2 graphics language commands. HP-GL/2 graphics may be created within application software or imported from existing applications. For various types of images (many technical drawings and business graphics, for example), it is advantageous to use vector graphics instead of raster graphics. Advantages include faster I/O transfer of large images and smaller storage requirements. See Chapter 17 for more information.

I/O

I/O is an acronym for input/output (I/O) and is used in this document when referring to hardware used to interface printers with computers.

I/O Buffer

The area within the printer's internal random access memory (RAM) where PCL commands and data are stored.

Interface Connector

The LaserJet printer comes with two interface connectors, serial and parallel, located on the lower part of the back panel. The cable that attaches the computer to the printer is connected here. (Also see *Parallel I/O* or *Serial I/O*.)

Internal Fonts

Internal fonts are the fonts resident in the printer when shipped.

Landscape

See *Orientation*.

Logical Page

The PCL logical page (also referred to as the addressable area) defines the area in which the cursor can be positioned. Although the printer does not actually have a cursor (like the blinking underline character used on most computer terminals), the cursor position refers to the currently active printing position (CAP). In other words, the location of the “cursor” is the position on the logical page where the next character is positioned. You can move the cursor to different points on the logical page using the cursor positioning commands; however, the cursor cannot be moved outside of the logical page bounds.

Macro

A macro is a collection of escape sequences, control codes, and data downloaded to the printer, whose execution can be initiated using a single command.

Menu

A list of configurable items. In the nomenclature of this document, an “item” is one particular configurable entity (such as “Copies”); a “value” is an “item’s” particular configuration (such as “Copies=10”).

Modified Print Environment

The current printer feature settings constitute the modified print environment. Whenever a feature setting is altered using escape sequences, the new setting is recorded in the modified print environment.

MSL (Master Symbol List)

This is a group of symbols (a **symbol index**). An unbound font has the capacity to be bound to a set of symbols selected from a complementary symbol index (such as the MSL or Unicode symbol indexes). Each symbol in the index is identified by a unique MSL number. Appendix D of the *PCL 5 Comparison Guide* contains the MSL symbol index.

Negative angle of rotation

An angle used to create a plot in HP-GL/2 which is rotated in the direction of the +X-axis to the -Y-axis. Note that the relationship of the +X-axis to the -Y-axis can change as a result of scaling point or scaling factor changes, thus changing the direction of a negative angle of rotation. See "Drawing Arcs" in Chapter 20 for more information.

Non-volatile RAM

Random Access Memory whose contents are preserved following a power failure (volatile RAM is memory whose contents are not preserved when the device is powered off). Non-volatile RAM is generally used to preserve configured (vs. programmed) device state information.

Off-line/On-line

On-line is a condition when the printer will accept data from the host computer. When the printer is on-line, the ON LINE lamp is lit. When off-line, the printer will not accept data from the host.

Orientation

The orientation of characters on a page; if the print is across the width of the page, it is "portrait-oriented;" if the print is across the length of the page, it is "landscape-oriented."

Overlay Environment

The overlay environment consists of the current settings for the following features with the remainder of the environment features set to their user default values: Paper source, Page size, Number of copies, Orientation, Cursor position stack.

Parallel I/O

An input/output (I/O) interface that transmits more than one bit of information simultaneously (in a “parallel” mode). Centronics is an industry-wide parallel interface standard. (Also see *Serial I/O*.)

PCL Commands

PCL commands provide access to printer features. Once a PCL command sets a parameter, that parameter remains set until the same PCL command is repeated with a new value, or the printer is reset. There are three types of PCL commands: control codes, two-character escape sequences, and parameterized escape sequences. (Also see *escape sequences*.)

PCL Coordination System Units

The units of the X-axis of the PCL coordinate system may be dots, decipoints, or columns. The units of the Y-axis may be dots, decipoints, or rows.

PCL Units

These are user-definable units of measure which are used in PCL commands affecting various PCL cursor moves. The number of units-per-inch used in PCL cursor moves is determined by the current setting of the **Unit of Measure** command (see “Unit of Measure Command” in Chapter 4).

Note

PCL Units were previously referred to as “PCL dots,” but *should not be confused with the printer’s physically printed dots*.

Perforation Region

The perforation region is the distance from the bottom of the text area to the top of the text of the next page. When perforation skip is enabled, a Line Feed or Half-Line Feed, which would move the cursor beyond the bottom of the text area, moves the cursor to the top of the text area on the next page. When perforation skip is disabled, a Line Feed or Half-Line Feed moves to the next line or half-line within the perforation region.

Pitch

Pitch describes the number of characters printed in a horizontal inch. Pitch only applies to fixed-spaced fonts since the number of characters per inch varies for proportionally-spaced fonts.

PJL

PJL (Printer Job Language) commands provide job-level control, such as the ability to switch printer languages (or “personalities” - such as PCL to PostScript) between jobs. PJL also provides two-way communications with the printer. PJL can also be used to change the printer’s control panel settings and modify the message displayed on the control panel.

Point

A PCL point is a unit of measurement that equals 1/72nd inch. Font height is measured in points.

Positive angle of rotation

An angle used to create a plot in HP-GL/2 which is rotated in the direction from the +X-axis to the +Y-axis. Note that the relationship of the +X-axis to the +Y-axis can change as a result of scaling point or scaling factor changes, thus changing the direction of a positive angle of rotation. See “Drawing Arcs” in Chapter 20 for more information.

Primary (Secondary) Font

A PCL convention whereby two fonts can be defined internally simultaneously. The primary font is accessed via the control code “SI” and the secondary font is accessed via the control code “SO.” The factory default state is primary font designated.

Printable Area

The printable area is the area of the physical page in which the printer is able to place a dot. The physical page refers to the size of the media installed in the printer.

The relationship between physical page, logical page, and printable area is defined in Figures 2-2 and 2-3.

Portrait

See *Orientation*.

Print Environment

The group of all the printer's current feature settings, collectively, is referred to as the print environment. The printer identifies four levels of changes of this print environment: the factory default environment, the user default environment, the modified print environment and the overlay environment.

Printer Commands

See PCL Commands and HP-GL/2.

Printing Menu

Identifies a few printer features which can be selected from the printer's Operator Control Panel, [[Menu]] key. Print menu features select the user default items, which are included in the print environment (features which can be selected with printer commands).

Raster Graphics

Images composed of groups of dots are raster images. Pictures in newspapers or on televisions are examples of raster images. PCL includes commands for printing raster images.

Reset

Resets are used to return the printer to a known environment. Depending on the type of reset performed, the printer returns to either the User Default Environment or the Factory Default Environment.

A Printer Reset restores the User Default Environment and deletes temporary fonts, macros, user-defined symbol sets and patterns. A Printer Reset is performed by sending the ?E command or through the printer's control panel (see the printer *User's Manual*).

Resolution

The high quality output achieved by HP LaserJet printers is due in part to the ability to lay down a fine grid of “dots” on the page. The density of this grid is referred to as the printer’s **resolution**. Resolution is expressed as a value of dots-per-inch. Until recently, all HP LaserJet family printers printed at a resolution of 300 dots-per-inch. In a one inch square, the printer could print a dot anywhere in a grid of up to 300 dots horizontally by 300 dots vertically, for a total of 90,000 possible dot locations per square inch ($300 \times 300 = 90,000$).

The LaserJet 4 printer is capable of printing at either 300 or 600 dpi resolution. At 600 dots-per-inch, it becomes possible to print up to 360,000 dots per square inch ($600 \times 600 = 360,000$).

Robust-Xon

The configuration of ROBUST-XON determines the method by which Xon signals are generated on the interface. If ROBUST-XON is ON, an Xon is transmitted from the printer to the host computer when the printer’s 1 Kbyte I/O buffer has less than 128 data bytes remaining (896 bytes empty). The printer must be in the on-line state and not busy. If no data is received, additional Xon’s are transmitted at one second intervals.

If ROBUST-XON is OFF, the printer sends one Xon signal when the printer is in the on-line state, and is not busy. The printer does not send additional Xon signals.

Row

The distance between rows is defined by the current vertical motion index (VMI).

Rule

A solid-filled rectangular area.

Scalable

PCL 5 printers can use either bitmap or scalable fonts. A bitmap font is available in its one, defined size only. Scalable fonts, on the other hand, provide an “outline” for each character which can be scaled by the PCL 5 printers to produce a large range of character sizes.

Serial I/O

An input/output (I/O) interface that transmits information bit-by-bit (in “serial” mode). RS-232 is an industry-wide standard form of a serial interface.

Soft Font

Soft fonts are fonts stored on disks. These fonts can be transferred to the printer’s memory and used the same way as cartridge or resident fonts.

Spacing

Fonts have either fixed or proportional spacing. Fixed-spaced fonts are those for which the inter-character spacing is constant. In proportionally-spaced fonts, inter-character spacing varies with the natural shape of a character.

Stroke Weight

Stroke weight describes the thickness of the strokes that compose characters. Medium and bold are examples of stroke weights.

Style

Font style is defined by the angularity of the strokes of the characters with respect to the X-axis. Upright, italic, and condensed are examples of font styles.

Symbol Index

This is a grouping of symbols. An unbound font has the capacity to be bound to a set of symbols selected from a complementary Symbol Index (such as the Unicode or the MSL symbol indexes). Each symbol in the index is identified by a unique symbol index number. Appendix D of the *PCL 5 Comparison Guide* contains lists of MSL and Unicode symbol index characters and their numbers (also see *Unicode* or *MSL*).

Symbol Set

A symbol set is a unique ordering of the characters in a font. Each symbol set is defined with a unique set of applications in mind. Symbol sets are created for many purposes, for example, the PC-8 symbol set was designed to support US IBM-PC applications.

Treatment

Treatment is the combination of font style and/or weight. For example, some treatments of Times Roman font include: upright, or bold, or italic.

Typeface

Typeface is a generic name for graphics symbols having common design features. Each typeface has unique and distinguishing characteristics.

UEL (Universal Exit Language) Command

The Universal Exit Language (**UEL**) command (`?%-12345X`) causes the PCL printer language to shut down and exit. Control is then returned to the Printer Job Language (PJL). Both PCL 5 and HP-GL/2 recognize this command.

The UEL Command has the same effect as the `?E` command, and also enters PJL Mode of operation for printers that support PJL (refer to the section, “Universal Exit Language Command” in Chapter 4 for more information).

Unicode

This is a grouping of symbols (a **symbol index**) used by TrueType fonts. An unbound font has the capacity to be bound to a set of symbols selected from a complementary symbol index (such as the Unicode or MSL symbol indexes). Each symbol in the index is identified by a unique Unicode number. Appendix D of the *PCL 5 Comparison Guide* contains the Unicode symbol index.

Unit of Measure

The number of units-per-inch used in PCL cursor moves is determined by the current setting of the **Unit of Measure** command. The current unit of measure setting affects all PCL Unit moves, horizontal and vertical rectangle size, bitmap and scalable font metrics (how the cursor moves after printing a character). See “Unit of Measure Command” in Chapter 4.

User Default

A default selectable through the printer’s control panel. For example, user defaults may be selected for number of copies, manual feed mode, fonts, and vertical form length (VMI).

User Default Environment

The User Default Environment consists of the user default settings (any user default settings selected from the control panel) with the remainder of the environment features set to the factory default values.

User-Defined Pattern

In addition to the eight shading patterns and six cross-hatch patterns, users can design their own patterns (area fill). These **user-defined patterns** are downloaded to the printer and used in subsequent area fills. See “User-Defined Pattern Graphics” in Chapter 13.

User-Defined Symbol Sets

User-defined symbol sets are supported in some HP LaserJet printers. Symbols are user-selected from a Symbol Index, (such as Unicode or MSL). To specify a user-defined symbol set, use the symbol set ID value as defined by the *Symbol Set ID Code Command*. See Chapter 10 for more information.

Vector Graphics

A method of drawing lines, area fills and other objects which is generally more efficient than “raster graphics.” Also see “HP-GL/2.”

Vertical Motion Index (VMI)

VMI (vertical motion index)

VMI defines the distance between rows in 1/48th inch increments. This command affects the Line Feed and Half-Line Feed spacing.

The factory default VMI is eight, which corresponds to six lines per inch. A user default VMI can be selected from the control panel using the FORM menu item.

Index

Symbols

- !!PCL 5 Comparison Guide!! x
- !!Software Application Notes!! vi
- !!TrueType Font File Specification!! x
- #A - Page Size 5-2
- #C - Vertical Motion Index 5-22
- #D - Line Spacing 5-24
- #E - Top Margin 5-16
- #F - Text Length 5-18
- #G - Output Bin Selection 4-12
- #H - Paper Source 5-4
- #L - Perforation Skip 5-19
- #O - Page Orientation 5-5
- #S - Simplex/Duplex Print 4-5
- #U - Left Offset Registration 4-7
- #X - Number of Copies 4-4
- #Z - Top Offset Registration 4-8
- %&minus 4-3
- &&ell 4-4, 4-5, 4-7, 4-8, 4-11, 4-12, 5-4, 5-5, 5-16, 5-18, 5-19, 5-22, 5-24
- &&a#C - Horizontal Cursor Positioning (Columns) 6-4
- &&a#G - Duplex Page Side Selection 4-10
- &&a#H - Horizontal Cursor Positioning (Decipoints) 6-6
- &&a#L - Left Margin 5-13
- &&a#M - Right Margin 5-14
- &&a#P - Print Direction 5-9
- &&a#R - Vertical Cursor Positioning (Rows) 6-9
- &&a#V - Vertical Cursor Positioning (Decipoints) 6-11
- &&d#D - Enable Underline 8-29
- &&d@ - Disable Underline 8-29
- &&f#S - Push/Pop Cursor Position 6-14
- &&f#X - Macro Control 12-7
- &&f#Y - Macro ID (assign) 12-6
- &&k#G - Line Termination 6-13
- &&k#H - Horizontal Motion Index 5-20
- &&p#X - Transparent Mode 8-28
- &&r#F - Flush All Pages 16-24
- &&r#T - Inquire Status Readback Entity 16-10
- &&r#T - Set Status Readback Location Type 16-8
- &&r#T - Set Status Readback Location Unit 16-9
- &&s#C - End-Of-Line Wrap 24-12
- &&u#B - Unit Of Measure 4-13
- &sp 6-13
- (#B - Primary Stroke Weight 8-16
- (#X - Primary Font Selection by ID # 8-26
- (3@ - Select Default Font as Primary 8-27
- (B), boolean 10-5, 11-14, 11-51
- (#W - Define Symbol Set 10-4
- (ID - Primary Symbol Set 8-6
- (s#H - Primary Pitch 8-10
- (s#P - Primary Spacing 8-9
- (s#S - Primary Style 8-14
- (s#T - Typeface, Primary 8-18
- (s#V - Primary Height 8-12
- (s#W - Character Descriptor/Data 11-50
- (SB), signed byte 10-5
- (SI), signed integer 10-5
- (SLI), signed long integer 10-5
- (UB), unsigned byte 10-5
- (UI), unsigned integer 10-5
- (ULI), unsigned long integer 10-5
-) 1-3, Glossary-4
-)#X - Secondary Font Selection by ID # 8-26
-)&&ell 5-2
-)3@ - Select Default Font as Secondary 8-27
-)ID - Secondary Symbol Set 8-6
-)s#B - Secondary Stroke Weight 8-16
-)s#H - Secondary Pitch 8-10
-)s#S - Secondary Style 8-14
-)s#T - Typeface, Secondary 8-18
-)s#V - Secondary Height 8-12
-)s#W - Font Header 11-6
-)s1P - Secondary Spacing 8-9
- *b#M - Set Compression Method 15-16
- *b#W - Transfer Raster Data 15-29
- *b#Y - Raster Y Offset 15-15
- *c#A - Horizontal Rectangle Size (PCL Units) 14-3
- *c#B - Vertical Rectangle Size (PCL Units) 14-4
- *c#D - Font ID (assign) 9-4
- *c#E - Character Code 11-49
- *c#F - Font Control 9-5
- *c#H - Horizontal Rectangle Size (Decipoints) 14-3
- *c#P - Fill Rectangular Area 14-9
- *c#Q - Pattern Control 13-23
- *c#R - Symbol Set ID Code 10-2
- *c#S - Symbol Set Control 10-12

*c#V - Vertical Rectangle Size (Decipoints) 14-4

*c#W - User-Defined Pattern 13-16

*p#R - Set Pattern Reference Point 13-22

*p#X - Horizontal Cursor Positioning (PCL Units) 6-6

*p#Y - Vertical Cursor Positioning (PCL Units) 6-12

*r#A - Start Raster Graphics 15-14

*r#F - Raster Graphics Presentation 15-8

*r#T - Raster Height 15-11

*r#T - Raster Width 15-13

*rC - End Raster Graphics 15-30

*s#M - Free Space 16-21

*s#X - Echo 16-25

*t#R - Raster Graphics Resolution 15-6

*v#N - Source Transparency Mode 13-6

*v#O - Pattern Transparency mode 13-7

*v#T - Select Current Pattern Command 13-12

= &sp 6-13

``ERROR 20'-memoryoverflow' 16-2, 24-15

``ERROR 21'-printoverrun' 24-10, 24-15

``ERROR 22'-bufferoverflow' 24-15

``ERROR 40'-datatransfer' 24-15

Numerics

12345X - Universal Exit Language 4-3

1T - Job Separation 4-11

9 - Clear Horizontal Margins 5-15

A

AA command 20-9

Absolute Arc Three Point command 20-16

Absolute Character Size command 23-8, 23-14, 23-74

absolute cursor positioning 6-2, 24-5

Absolute Direction command 23-9, 23-21, 23-29

absolute vs. relative pen movement 17-25

AC command 22-5, 22-6

AD command 23-18

adaptive compression

- block size 15-25, 15-27
- compression methods 15-25
- control bytes 15-25
- cursor position 15-27
- data block 15-25
- delta row 15-25, 15-27
- duplicate row 15-25, 15-26, 15-27
- empty row 15-25, 15-26, 15-27
- format 15-25
- operation hints 15-27
- row length 15-27
- run-length encoded 15-25, 15-27

seed row 15-27

TIFF 15-25, 15-27

y-offset 15-27

addressable area 2-2

Advance Full Page command 19-33

alternate (secondary) font 23-56

alternate font (HP-GL/2) selection 23-66

Alternate Font Definition command 23-18

alternate vs. standard fonts, HP-GL/2 23-17

Anchor Corner command 22-5, 22-6

anchor corner, changing (example) 22-6

anchor point, picture frame 18-1, 18-10

angle of rotation 20-7, 21-6

angle of rotation, negative Glossary-8

angle of rotation, positive Glossary-10

angles, measuring 23-31

angularity 7-6

anisotropic scaling 19-4, 19-41, 19-42

AP (Application Support), Format 15 11-41

AR command 20-13

Arc Absolute command 20-5, 20-9

Arc Relative (AR) command 20-5

Arc Relative command 20-13

arcs, drawing 20-5

area fill ID command - !!see also!! pattern ID command 13-8, 14-5

area fill, user-defined patterns - !!also see!! user-defined patterns 13-13

ASCxx 10-5, 11-14

aspect ratio 19-8, Glossary-1

assigning font ID numbers 9-4

assist line, HP Customer Support-2

AT command 20-7, 20-16

auto-continue 24-14, Glossary-1

automatic macro overlay 12-4, 24-8

automatic pen down 17-21

auto-rotation, font 8-20

B

Backspace 6-7

base pattern 13-13

baseline position, font header 11-18

BASIC, HP-GL/2 example 17-13

baud rate Glossary-1

Bezier Absolute (BZ) command 20-8, 20-22

Bezier curves (HP-GL/2) 20-8

Bezier Relative (BR) command 20-8, 20-19

bi-directional I/O 16-2

binary data 1-6, 15-1

binding modes 4-5

bitmap fonts 7-2, 7-9, 11-2

- character descriptor format 11-51

- character design data 11-57
- coordinate system 11-4
- header 11-7, 11-8
- status readback 16-12
- black fill 14-9
- black rule 13-12
- block size, adaptive compression 15-25
- bold stroke weight 7-6
- boolean (B), data type 10-5, 11-14, 11-51
- bottom margin 24-4
- bound font 9-8, Glossary-1
- boundaries
 - landscape page 2-8
 - limiting, HP-GL/2 17-19
 - PCL Picture Frame 19-6
 - portrait page 2-7
 - printable area 2-7, 2-8
- boundaries, page 2-2
- BR command 20-8, 20-19
- BS, Backspace 6-7
- buffer overflow, ('`ERROR 22') 24-15
- byte counts 15-29
- BZ command 20-8, 20-22

C

- C programming language, HP-GL/2
 - example 17-13
- call macro 12-4
- CAP (current active position) 2-2, 6-1, 17-21
- cap height 23-74
- cap height, font header 11-31
- Carriage Return (CR)
 - control code 6-7
 - line termination modes 6-13
 - point (HP-GL/2) 23-5, 23-26, 23-29, 23-37, 23-41, 23-63
 - suppressing 24-7
- cartridge
 - fonts 7-2
 - fonts, status readback 16-8
 - macro 12-1
- CC (Character Complement) 11-41
- cell height, font header 11-18
- cell width, font header 11-18
- centronics I/O Glossary-2
- CF command 23-20
 - example 23-22
- chapter summaries vi
- character
 - height 7-5
 - orientation 8-20
 - pitch, font selection 8-10
 - positioning 2-9
 - spacing 24-5
- character cell 11-4, 23-12
- illustration 11-19
- Intellifont 11-4
- TrueType 11-5
- character clipping 2-8
- character code
 - and symbol index numbers 9-11
 - command 11-49
 - delete 9-5
- character complement 10-7
 - font header field 11-35
 - numbers 9-10
- character coordinates, TrueType 11-5
- character data
 - blocks 11-48
 - character descriptor field 11-57
 - compression 11-54
 - height 11-57
 - Intellifont 11-64
 - TrueType size 11-69
- character definition
 - command 11-50
 - examples 11-70
 - PCL 11-48
- character descriptor 11-1, 11-62, Glossary-2
 - bitmap example, landscape 11-72
 - bitmap example, portrait 11-70
- character data 11-57
- character data compression 11-54
- character header 11-51
- checksum 11-64, 11-69
- class 11-53, 11-62, 11-63, 11-68
- component list 11-65
- compound 11-61
- continuation 11-52, 11-68
- cursor positioning 11-57
- data offset 11-63, 11-64
- data size 11-63, 11-69
- data types 11-51
- delta 11-57
- format 11-52
- glyph ID 11-69
- height 11-57
- Intellifont scalable fonts 11-60
- left offset 11-56, 11-68
- number of components 11-65
- orientation 11-56
- PCL bitmap fonts 11-51
- scalable contour data format 11-61
- size 11-53, 11-62, 11-68
- top offset 11-56, 11-68
- tree data 11-64
- tree offset 11-64
- TrueType 11-65
- width 11-57, 11-68
- xy coordinate data 11-64

- xy data offset 11-64
- character design 7-7
- Character Fill Mode command 23-20
- Character Group (HP-GL/2) 23-1
 - commands list 17-5
 - commands summary 23-1
- character orientation 7-8
- character origin 23-63
- Character Plot (CP) command 23-5, 23-8, 23-16, 23-24
- character positioning 6-1
- character requirement
 - MSL 10-7
 - number 9-10
 - Unicode 10-9
 - user-defined symbol set header 10-7
- character row height 5-22
- character sets (fonts) 7-1
- character size (HP-GL/2) 23-8, 23-74
- Character Slant command 23-8, 23-78
- character slope 23-29
- character space 23-8
 - adjusting 23-51
- character spacing 24-4
 - fixed-spaced fonts 5-20
 - horizontal 7-5
- character stroke weight 8-16
- character style 8-14
- character thickness 7-6
- character, parameter/parameterized 1-6
- characteristics, font 8-1, 24-5
- characters
 - designing large, continuation 11-53
 - printable range 11-30
 - user-defined symbol sets 10-4
- characters-per-inch 7-5, 8-10
- checksum
 - character descriptor 11-64, 11-69
 - font header 11-39, 11-42
- chord angle 20-10, 20-25, 21-16
 - and circle smoothness 20-26
 - example 20-10
 - varying (example) 20-11
- CI command 20-25
- circle
 - and arc, counting points in 21-16
 - and wedges, filling 21-8
 - drawing in HP-GL/2 mode 20-4
 - drawing in polygon mode 21-14
 - smoothness and chord angle 20-26
- Circle command 20-4, 20-25
- clamped integer 17-10
- clamped real number 17-10
- class 2, character descriptor 11-54
- class 3, character descriptor 11-63
- class 4, character descriptor 11-63
- class, character descriptor 11-53, 11-68
- clear horizontal margins command 5-15
- clearing
 - status readback 16-5
- clipping 2-8
 - raster area 15-11
- CO command 19-19
- coding efficiency, raster compression 15-19
- cold reset 3-9
- column Glossary-2
- columns 5-20
- columns and rows 2-5, 6-4
- combining commands 1-8
- comma 17-9
- command
 - parameter 1-3
 - parsing 24-2
 - processing time 24-10
- commands 1-3
 - display functions 24-12
 - HP-GL/2 1-4
 - PCL 1-3
 - PJL 1-4
 - unsupported PCL 1-2
- commands, HP-GL/2
 - AA (Arc Absolute) 20-5, 20-9
 - AC (Anchor Corner) 22-5, 22-6
 - AD (Alternate Font Definition) 23-18
 - AR (Arc Relative) 20-5, 20-13
 - AT (Absolute Arc Three Point) 20-16
 - BR (Bezier Relative) 20-8, 20-19
 - BZ (Bezier Absolute) 20-8, 20-22
 - CF (Character Fill Mode) 23-20
 - CI (Circle) 20-4, 20-25
 - CO (Comment) 19-19
 - CP (Character Plot) 23-5, 23-8, 23-16, 23-24
 - DF (Default Values) 17-23, 19-3, 19-19
 - DI (Absolute Direction) 23-9, 23-21, 23-29
 - DR (Relative Direction) 23-9, 23-21, 23-37
 - DT (Define Label Terminator) 23-11, 23-44
 - DV (Define Variable Text Path) 23-9, 23-29, 23-30, 23-37, 23-46
 - EA (Edge Rectangle Absolute) 21-3, 21-17
 - EP (Edge Polygon) 21-21
 - ER (Edge Rectangle Relative) 21-3, 21-23
 - ES (Extra Space) 23-8, 23-16, 23-51
 - EW (Edge Wedge) 21-27
 - EW (Edge Wedge) 21-7
 - FI (Select Primary Font) 23-54

FN (Select Secondary Font) 23-56
 FP (Fill Polygon) 21-12, 21-31
 FT (Fill Type) 22-9
 Horizontal Picture Frame Size 18-8
 HP-GL/2 Plot Horizontal Size 18-11
 HP-GL/2 Plot Vertical Size 18-12
 IN (Initialize) 19-3, 19-15, 19-21
 IP (Input P1 and P2) 19-23, 19-36
 IR (Input Relative P1 and P2) 19-26
 IW (Input Window) 19-18, 19-29
 LA (Line Attribute) 22-2
 LA (Line Attributes) 22-15
 LB (Label) 23-3, 23-59
 LO (Label Origin) 23-10, 23-62
 LT (Line Type) 22-2, 22-22
 PA (Plot Absolute) 17-25, 20-30
 PD (Pen Down) 17-21, 20-2, 20-31
 PE (Polyline Encoded) 20-34
 PG (Advance Full Page) 19-33
 PM (Polygon Mode) 21-34
 PR (Plot Relative) 20-44
 PU (Pen Up) 17-22, 20-46
 PW (Pen Width) 22-29, 23-21
 PW (Pen Width) 22-5
 RA (Fill Rectangle Absolute) 21-39
 RF (Raster Fill Definition) 22-32
 RO (Rotate Coordinate System) 17-17,
 19-24, 19-28, 19-34
 RP (Replot) 19-39
 RR (Fill Rectangle Relative) 21-42
 RT (Relative Arc Three Point) 20-48
 SA (Select Alternate Font) 23-66
 SB (Scalable or Bitmap Fonts) 23-31,
 23-67
 SC (Scale) 17-24, 19-4, 19-15, 19-40
 Scale (SC) 17-20
 SD (Standard Font Definition) 23-68
 Set Picture Frame Anchor Point 18-10
 SI (Absolute Character Size) 23-8,
 23-14, 23-74
 SL (Character Slant) 23-8, 23-78
 SM (Symbol Mode) 22-35
 SP (Select Pen) 22-5, 22-38
 SR (Relative Character Size) 23-8,
 23-14, 23-81
 SS (Select Standard Font) 23-85
 SV (Screened Vectors) 22-39
 TD (Transparent Data) 23-86
 TR (Transparency Mode) 22-38, 22-42
 UL (User-Defined Line Type) 22-44
 WG (Fill Wedge) 21-45
 WG (Fill Wedge) 21-27
 WU (Pen Width Unit Selection) 22-46
 commands, HP-GL/2 (listing of) 17-3
 commands, PCL
 ?*c#G - Pattern (Area Fill) ID 13-8, 14-5
 area fill ID - !!see also!! pattern ID 13-8,
 14-5
 character code 11-49
 character descriptor 11-50
 define symbol set 10-4
 Disable Underline command 8-29
 duplex page side selection 4-10
 echo 16-25
 End Raster Graphics 15-30
 Enter HP-GL/2 Mode 18-13
 Enter PCL Mode 18-14
 fill rectangular area 14-9
 Flush All Pages 16-24
 Font Control 9-5
 font header 11-6
 Font ID # 9-4
 font selection by ID # 8-26
 Free Space 16-21
 Half-Line Feed 6-13
 height font selection 8-12
 horizontal cursor position (columns) 6-4
 horizontal cursor position decipoints 6-6
 horizontal cursor position Units 6-6
 horizontal motion index (HMI) 5-20
 Horizontal Rectangle Size (decipoints)
 14-3
 Horizontal Rectangle Size (PCL Units)
 14-3
 inquire status readback entity 16-10
 job separation 4-11
 left margin 5-13
 left offset registration 4-7
 line spacing 5-24
 line termination 6-13
 macro control 12-7
 Macro ID 12-6
 Number of Copies 4-4
 orientation 5-5
 output bin selection 4-12
 page size 5-2
 paper source 5-4
 pattern control 13-23
 pattern ID 13-8, 14-5
 pattern transparency mode 13-7
 Perforation Skip 5-19
 pitch command 8-10
 print direction 5-9
 push/pop cursor position 6-14
 raster graphics presentation 15-8
 raster graphics resolution 15-6
 raster graphics, start 15-14
 Raster Height command 15-11
 Raster Width command 15-13
 raster y offset 15-15
 Right Margin 5-14
 Select Current Pattern command 13-12

Select Default Font 8-27
 Set Pattern Reference Point 13-22
 Set Raster Compression Method 15-16
 set status readback location type 16-8
 set status readback location unit 16-9
 simplex/duplex print 4-5
 Source Transparency Mode 13-6
 spacing 8-9
 stroke weight, font selection 8-16
 Style, Font Selection 8-14
 symbol set 8-6
 symbol set control 10-12
 symbol set ID code 10-2
 Text Length 5-18
 top margin 5-16
 Top Offset Registration 4-8
 transfer raster data 15-29
 Transparent Print Data 8-28
 typeface, font selection 8-18
 Underline command 8-29
 Unit of Measure 4-13
 Universal Exit Language 4-3
 user-defined pattern 13-16
 Vertical Cursor Position (decipoints) 6-11
 Vertical Cursor Position (PCL Units) 6-12
 vertical cursor position rows 6-9
 Vertical Motion Index (VMI) 5-22
 Vertical Picture Frame Size 18-9
 Vertical Rectangle Size 14-4
 Vertical Rectangle Size (decipoints) 14-4
 Comment (CO) command 19-19
 compatibility 1-1
 component list 11-65
 components, Intellifont character descriptor 11-65
 compound character 11-62
 compound character descriptor, scalable 11-61
 compound character escapement 11-65
 compound scalable character 11-63
 compression Glossary-2
 adaptive 15-25
 adaptive (operation hints) 15-27
 bitmap character data 11-53, 11-54
 byte counts 15-29
 delta row 15-16, 15-20, 15-24
 raster data 15-13, 15-16, 15-19
 run-length 15-16
 TIFF 15-17
 TIFF, raster data 15-16
 CompuServe HP Forum Customer Support-1
 configuration Glossary-2
 Configuration and Status Group 19-1
 Configuration Group (HP-GL/2 commands) 17-3
 Configuration Menu Glossary-2
 continuation
 character descriptor 11-53, 11-62, 11-68
 user-defined pattern descriptor 13-17
 control
 user-defined symbol sets 10-12
 control bytes, adaptive compression 15-25
 control characters, printing 23-86
 control codes 1-3, Glossary-3
 character printing 8-28
 horizontal cursor positioning 6-7
 in labels 23-6
 printing 24-12
 Space character 5-20
 vertical cursor positioning 6-13
 control panel Glossary-3
 coordinate pairs 17-16
 coordinate system
 Agfa design window 11-4
 HP-GL/2 2-6, 17-15
 matching HP-GL/2 and PCL 19-15
 PCL 2-1, 2-4
 physical 11-4
 Rotate (RO) command 19-34
 TrueType 11-5
 units 6-3
 copies, number of 4-4
 copyright, font header 11-39
 CP (Character Plot) cell 23-8, 23-14
 CP (Character Plot) command 23-5, 23-8, 23-16, 23-24, 23-26
 CP (copyright field) 11-41
 CR (Carriage Return) 6-7
 cross-hatch 22-4, 22-9
 fill pattern 14-9
 patterns 13-11, 14-8
 patterns selection 13-8, 14-5
 current active position (CAP) 2-2, 6-1, 17-21, Glossary-1, Glossary-3
 current pattern 13-2
 Current Pattern command 13-12
 current units 17-11
 currently selected, status 16-3
 cursor Glossary-3
 cursor positioning 2-2
 absolute 6-2, 24-5
 adaptive compression 15-27
 and Unit Of Measure command 4-13
 CAP Glossary-1
 character printing 6-1
 clipped character 24-12
 columns 6-4
 commands 6-1

- control codes, horizontal 6-7
- control codes, vertical 6-13
- decipoints 6-6, 6-11
- End-of-Line Wrap 24-12
- half-line 6-13
- hints 24-5
- HP-GL 6-1
- PCL Units 6-6, 6-12
- printing characters 11-57
- raster graphic 15-29
- relative 6-2, 24-5
- rows 6-9
- saving 6-14
- stack 6-14
- top margins 5-16
- units 6-3
- vertical 5-16
- customer support Customer Support-1

D

- data block, adaptive compression 15-25
- data compression 15-2
 - bitmap character 11-53
 - class 2 character data 11-54
 - raster data 15-13
- data offset, scalable character descriptor,
 - Intellifont 11-64
- data processing, suspending 16-24
- data segments, formats 11-41
- data size, Intellifont character descriptor
 - 11-63
- data type 10-5, 11-14
- data, user-defined pattern 13-18
- decipoint 2-5, 6-6
 - (defined) 2-5, 6-4, Glossary-3
 - vs. typographic point 6-4
- default
 - (defined) Glossary-3
 - (HP-GL/2) 18-15
 - factory settings 3-2
 - HP-GL/2 19-3
 - HP-GL/2 settings 3-5
 - HP-GL/2 table 19-19
 - label conditions (HP-GL/2) 23-7
 - location, P1 and P2 19-23
 - print resolution 2-3
 - setting 3-1
 - user environment 3-6, 3-8
- Default Values command 17-23, 19-3,
 - 19-19
- Default Values command 17-10
- DEFID= (fontinternallIDnumber) 16-15
- Define Label Terminator command 23-11,
 - 23-44
- Define Symbol Set command 10-4
- Define Variable Text Path command 23-9,
 - 23-29, 23-30, 23-37, 23-46
- deleting
 - fonts 9-3
 - macros 12-6
- delta row compression
 - adaptive compression 15-25, 15-27
 - raster graphics 15-16, 15-20
- delta X, character descriptor 11-57
- descriptor
 - character 11-1
 - font header 11-1
 - user-defined pattern header 13-16
- design units 11-4
- design window, Intellifont character cell
 - 11-4
- destination image 13-1, 13-2
- DF command 17-10, 17-23, 19-3, 19-19
- DI command 23-9, 23-21, 23-29
 - example 23-34
- disk fonts 7-2
- display functions
 - command 24-12
 - example 24-13
- document control 4-2
- dot Glossary-3
- dots vs. PCL Units 2-3, 4-15
- dots, printed 2-3
- downloading Glossary-4
- downloading fonts 9-2
 - bitmap (example) 11-43
 - Intellifont (example) 11-44
- DR command 23-9, 23-21, 23-37
 - example 23-41
- drawing
 - arcs 20-14
 - arcs (HP-GL/2) 20-5
 - Bezier curves (HP-GL/2) 20-8
 - Bezier curves, with absolute coordinates
 - 20-22
 - Bezier curves, with relative coordinates
 - 20-19
 - circles 21-14
 - circles (HP-GL/2) 20-4, 20-25
 - circles with different radii and line types
 - 20-28
 - equal-size pictures 19-11
 - lines (HP-GL/2) 20-2
 - pie charts, using EW 21-29
 - pie charts, using WG 21-49
 - polygons 21-10
 - rectangles 21-3
 - rectangles, using EA 21-18
 - rectangles, using ER 21-24
 - size (HP-GL/2) 19-9
 - subpolygons 21-11

- wedges 21-6
- driver, design for status 16-2
- DT command 23-11, 23-44
- DTR polarity Glossary-4
- Duplex Page Side Selection command 4-10
- duplex printing 4-5
- duplicate row, adaptive compression 15-25
- DV command 23-9, 23-29, 23-30, 23-37, 23-46
 - example 23-49

E

- E - Printer Reset 4-2
- EA command 21-3, 21-17
- Echo command 16-25
- edge pen 23-21
- Edge Polygon command 21-21
- Edge Rectangle Absolute command 21-17
- Edge Rectangle Absolute command 21-3
- Edge Rectangle Relative command 21-3, 21-23
- Edge Wedge (EW) command 21-7, 21-27
- edging 21-3
- effective window 17-19, 19-30, 20-2
- eject, page 19-33
- Em, defined 7-5
- empty row, adaptive compression 15-25
- encoded symbol set (user-defined symbol set) 10-6
- encoding raster data 15-2
- encoding X,Y coordinates 20-34, 20-37
- End Raster Graphics command 15-30
- ending labels 23-11
- end-of-line wrap
 - command 24-12
- end-of-text character 23-11, 23-44
- enlarging/reducing HP-GL/2 images 19-8
- Enter HP-GL/2 Mode command 18-13
- Enter PCL Mode command 18-14
- entity 16-3
- entity, status readback 16-3
- environment
 - factory default 3-1, 3-2
 - macro overlay 3-1
 - modified print 3-1, 3-7
 - reset 3-8
 - user default 3-1, 3-6, 4-2
- EP command 21-21
 - example 21-21
- ER command 21-3, 21-23
- erase pattern 14-9
- error clearing, automatic 24-14
- error codes, entity status readback 16-19
- ES command 23-8, 23-16, 23-51

- escape character (&esc 1-3, Glossary-4
- escape sequences
 - (defined) 1-3, Glossary-4
 - example 1-7
 - group character 1-6
 - parameter character 1-6
 - parameterized 1-5
 - printer commands 1-1
 - spacing 1-7
 - syntax 1-5
 - termination character 1-6
 - value field 1-6
- escape sequences (PCL)
 - &esc 4-2, 4-3, 4-4, 4-5, 4-7, 4-8, 4-10, 4-11, 4-12, 4-13, 5-2, 5-4, 5-5, 5-9, 5-13, 5-14, 5-15, 5-16, 5-18, 5-19, 5-20, 5-22, 5-24, 6-4, 6-6, 6-9, 6-11, 6-12, 6-13, 6-14, 8-6, 8-9, 8-10, 8-12, 8-14, 8-16, 8-18, 8-26, 8-27, 8-28, 8-29, 9-4, 9-5, 10-2, 10-4, 10-12, 11-6, 11-49, 11-50, 12-6, 12-7, 13-6, 13-7, 13-12, 13-16, 13-22, 13-23, 14-3, 14-4, 14-9, 15-6, 15-8, 15-11, 15-13, 15-14, 15-15, 15-16, 15-29, 15-30, 16-8, 16-9, 16-10, 16-21, 16-24, 16-25, 24-12
- ETX 23-11, 23-44
- even/odd fill method for polygons 21-12
- EW command 21-6, 21-7, 21-27
- execute macro 12-4
- exit language, universal (UEL)
 - Glossary-14
- exponential format 17-11
- Extra Space (ES) command 23-8, 23-16, 23-51

F

- factory default Glossary-4
- factory default environment 3-2, Glossary-5
 - HP-GL/2 context (table) 3-5
 - PCL context (table) 3-2
- faxback service, HP FIRST Customer Support-2
- feature settings 3-2
- FF, Form Feed 6-13
- FI command 23-54
- fill and line types 22-1
- fill examples, rectangular area 14-13
- fill patterns
 - starting position 22-6
 - user-defined 22-13
- Fill Polygon (FP) command 21-12, 21-31
- fill procedure, rectangular area 14-1
- Fill Rectangle Absolute command 21-39
- Fill Rectangle Relative command 21-42

- Fill Rectangular Area command 14-9
- Fill Type command 22-9
- fill types 22-4
- Fill Wedge (WG) command 21-27, 21-45
- filled rectangles 21-4
- filling characters (HP-GL/2) 23-20
- filling polygons 21-12
- final font selection 9-11
- first code
 - font header 11-30
 - user-defined symbol set header 10-7
- fixed underline 8-29
- fixed-spaced fonts
 - character spacing 5-20, 7-4, 8-9
 - font selection 8-23
 - printing 23-15
- floating underline 8-29
- Flush All Pages command 16-24
- FN command 23-56
- font 7-1
 - (defined) Glossary-5
 - alternate font definition 23-18
 - auto-rotation 8-20
 - bitmap 7-2, 7-9, 11-2
 - bitmap (in HP-GL/2 mode) 23-15
 - bitmap vs. scalable 7-2
 - bitmap, coordinate system 11-4
 - bound 9-8
 - bound and unbound 9-8, Glossary-1
 - cache 16-22
 - cartridge 7-2, Glossary-5
 - character cell, illustration 11-19
 - characteristic 23-19
 - characteristic priority 8-2
 - characteristics 7-1, 8-4, 24-5
 - classifications 11-2
 - Control command 9-5
 - control, symbol sets 10-12
 - copy/assign 9-5
 - data type 10-5
 - deleting 4-2, 9-3, 9-5, 24-8
 - descriptor size 11-15
 - design coordinate system 11-4
 - designating, HP-GL/2 (example) 23-73
 - disk 7-2
 - downloading 7-2, 9-2
 - entity 16-3
 - extended, status readback 16-10
 - filling characters (HP-GL/2) 23-20
 - fixed-spaced 7-4
 - font type header field 11-15
 - formats 7-2
 - header !!see also!! font header 11-1, 11-6
 - height (HP-GL/2) 23-71
 - height (PCL) 7-5
 - height measured in PCL points 23-15
 - HP-GL/2 alternate font selection 23-66
 - HP-GL/2 font size 23-74
 - HP-GL/2 fonts 23-15
 - HP-GL/2 ID number selection 23-54
 - HP-GL/2 selection using font ID 23-56
 - ID command 9-4
 - ID number 9-1, 23-56
 - Intellifont scalable 11-2
 - internal 7-2, 7-11
 - management 9-1
 - management, example 9-7
 - master size 11-4
 - memory (RAM) usage 7-8
 - mirror-images 23-74
 - number available 8-5
 - orientation 7-8, 8-20
 - patterned and shaded 7-11
 - permanent 9-3, 9-5, 16-8
 - posture (HP-GL/2) 23-71
 - primary and secondary 8-5
 - printed on angle 23-29, 23-37
 - printing 23-15
 - proportionally-spaced 7-4
 - RAM 7-2
 - resolution 8-5
 - ROM-based 7-2
 - rotation 7-8
 - scalable 7-2, 7-9, 11-2
 - scalable (in HP-GL/2 mode) 23-15
 - scalable or bitmap (HP-GL/2) 23-67
 - scaling technology, font header 11-34
 - secondary 8-5
 - select table 8-1, 8-4, 8-5
 - selection !!see also!! font selection 8-1
 - SIMM 7-2
 - size selection 8-9
 - soft 7-2
 - soft, status readback 16-13
 - spacing (HP-GL/2) 23-15, 23-70
 - special effects 7-11
 - status readback 16-10
 - Stick/Arc (in HP-GL-2) 23-15
 - stroke weight 7-6
 - stroke weight (HP-GL/2) 23-71
 - style 7-6
 - style values 8-14
 - styles (pictured) 8-15
 - symbol set (HP-GL/2) 23-69
 - symbol set (PCL) 7-3
 - temporary 9-3, 9-5, 16-8
 - TrueType 11-3
 - TrueType, character coordinates 11-5
 - typeface (HP-GL/2) 23-72
 - typeface designs (pictured) 7-7
 - unbound !!see also!! unbound font 9-8

- Font Control command 9-5
- font header 11-1, Glossary-5
 - baseline position 11-18
 - bitmap 11-7
 - bitmap character cell 11-19
 - bitmap example 11-43
 - calculating symbol set value 11-20
 - cap height, formula 11-31
 - cell height 11-18
 - cell width 11-18
 - character complement 11-35
 - checksum 11-39, 11-42
 - command 11-6
 - copyright 11-39
 - examples 11-43, 11-44
 - first code 11-30
 - font naming (ASCII) 11-33
 - font number 11-32
 - font scaling technology 11-34
 - font type 11-15
 - format byte 11-15
 - formats 11-7
 - formats of data segments 11-41
 - global Intellifont data 11-35
 - global italic angle 11-35
 - height 11-22
 - height extended 11-31
 - Intellifont bound 11-10
 - Intellifont unbound 11-11
 - last code 11-30
 - master underline position 11-34
 - master underline thickness 11-34
 - MSL symbol index 11-35
 - number of characters 11-30
 - OR threshold 11-35
 - orientation 11-19
 - pitch 11-21
 - pitch extended 11-21, 11-30
 - placement 11-28
 - quality 11-28
 - resolution-specified bitmap 11-8
 - scalable example 11-44
 - scale factor 11-34
 - segment size, Format 15 11-41
 - segmented font data, Format 15 11-39
 - segmented font identifier 11-40
 - serif style 11-27
 - size 10-5
 - spacing 11-19, 11-20
 - stroke weight 11-23
 - style LSB 11-23
 - style MSB 11-16
 - style word 11-16, 11-23
 - symbol set 11-19, 11-20
 - text height 11-29
 - text width 11-29
 - typeface LSB 11-24
 - typeface MSB 11-24
 - typeface vendor-version 11-26
 - typeface word 11-24
 - typeface, previous usage 11-26
 - underline position (distance) 11-29
 - underline thickness 11-29
 - variety 11-35
 - width type 11-23
 - X resolution 11-33
 - xheight 11-22
 - Y resolution 11-34
- font header formats of data segments
 - AP (Application Support Segment) 11-41
 - CC (Character Complement) 11-41
 - IF (Intellifont Face Data) 11-42
 - PF (PS-Compatible Font Name) 11-42
 - XW (x-windows font name) 11-42
- Font ID command 9-4
- font name, user designated (ASCII) 11-33
- font number, font header 11-32
- font selection 8-1
 - by characteristic 8-1, 23-68, 24-5
 - by ID 8-26, 24-6
 - escape sequence 8-21
 - example 8-21, 8-22
 - final 9-11
 - font select table 8-1
 - HP-GL/2 8-27, 23-17
 - priority 8-2, 8-3, 8-24, 23-19
 - short method 8-5
 - specifying 24-5
 - summary 8-23
 - unbound fonts 9-8
- Form Feed (FF) 6-13, 19-33, 19-39
- Format 0 font header (bitmap) 11-7
- Format 10 font header (Intellifont bound) 11-10
- Format 11 font header (Intellifont unbound) 11-11
- Format 15 font header (TrueType scalable) 11-13
- Format 20 font header (resolution-specified bitmap) 11-8
- format field
 - character descriptor 11-52
 - character descriptor (bitmap) 11-52
 - character descriptor (scalable) 11-62
 - TrueType character descriptor 11-67
 - user-defined pattern descriptor 13-17
 - user-defined symbol set 10-6
- FP command 21-12, 21-31
 - example 21-32

Free Space command, status readback 16-21
 FT command 22-9

G

gaps, in user-defined line types 22-44
 GI (Global Intellifont Data) 11-35, 11-41
 global italic angle, font header 11-35
 glyph ID, TrueType 11-69
 glyphs, TrueType, downloading 11-49
 graphic patterns 13-8, 14-5
 graphics

- cross-hatch patterns 14-1, 14-8
- errors 24-15
- limits (HP-GL/2) 17-19, 19-12
- patterns 14-1
- raster 15-1
- resolution 14-2
- shading 14-1, 14-6
- special effects 13-1
- transparency mode 13-1
- user-defined patterns 13-13
- vector Glossary-15

group character (PCL command) 1-6
 GT (Global TrueType Data) 11-41

H

Half-Line Feed 6-13
 Half-Line Feed command 6-13
 hard-clip limits 17-19
 hatching patterns 22-9
 header

- font 11-6
- user-defined symbol set 10-4

Header Size field (user-defined symbol set) 10-5

height

- (defined) Glossary-5
- character descriptor 11-57
- extended, font header 11-31
- font header 11-22, 11-23
- font selection 8-24
- pixels, user-defined pattern descriptor 13-18

Height command (font selection) 8-12

help, customer support Customer Support-1

HMI (Horizontal Motion Index) 6-3, Glossary-6

- command 5-20
- defining column width 2-5
- hints 24-4
- HMI command 5-20
- setting, affected by unit of measure 4-13

horizontal character spacing 7-5
 horizontal cursor positioning (columns) command 6-4
 (decipoints) command 6-6
 (PCL Units) command 6-6
 control codes 6-7
 horizontal escapement 23-16
 Horizontal Picture Frame Size command (decipoints) 18-8
 horizontal rectangle size (decipoints) command 14-3
 (PCL Units) command 14-3
 horizontal spacing 8-10
 horizontal tab 6-9
 HP customer support Customer Support-1
 HP Distribution Customer Support-2
 HP FIRST fax line Customer Support-2
 HP Forum, CompuServe Customer Support-1
 HP Personal Peripherals Assist Line Customer Support-2
 HP-GL/2

- !!Introduction!! 17-1
- (defined) Glossary-6
- adapting to match PCL 19-15
- character cell 23-12
- Character Group 17-5, 23-1
- character positioning 23-62
- character size and slant 23-8
- command sequence 18-5
- commands !!see also!! commands, HP-GL/2 1-4
- Configuration and Status Group 19-1
- Configuration Group 17-3
- coordinate system 2-6, 17-15, 19-15
- cursor positioning 6-1
- default conditions table 19-19
- default conditions, establishing 19-3
- default settings 18-15
- default values 17-9
- defining the image area 18-2
- designating a font, example 23-73
- drawing arcs 20-5
- drawing Bezier curves 20-8
- drawing circles 20-4
- drawing lines 20-2
- drawing polygons 21-10
- drawing rectangles 21-3
- drawing wedges 21-6
- effective window 17-19
- enlarging/reducing images 19-8
- Enter Mode command 18-13
- environment 3-7, 5-5
- factory default settings 3-5
- font selection 8-27
- font spacing 23-15
- font special effects 7-11
- graphics limits 17-19, 19-12

- image creation hints 24-9
 - importing existing images 17-25
 - labels 23-1
 - Line and Fill Attributes Group 17-6, 22-1
 - line segments, four types 19-18
 - line types/patterns 22-22
 - listing of commands 17-3
 - macro overlay environment 12-4
 - matching coordinate system with PCL 19-15
 - omitting optional parameters 17-9
 - orientation 17-17
 - page size-independent image 18-3
 - parameter formats 17-10
 - PCL picture frame 18-1
 - pen location 17-23
 - picture frame 2-6
 - picture frame scaling 18-3
 - Plot Horizontal Size 18-11
 - Plot Vertical Size 18-12
 - Polygon Group 17-4, 21-1
 - print area limiting boundaries 17-19
 - print environment 19-3
 - printing text 23-1, 23-59
 - programming languages 17-13
 - range of parameter values 17-10
 - reset 3-8
 - rotate coordinate system 19-34
 - scaling factor 18-2
 - selecting fonts 23-17, 23-68
 - state variables 5-5
 - syntax 17-6
 - terminating labels 23-11
 - units of measure 17-20
 - using fonts 23-15
 - varying text/line spacing 23-8
 - vector fill 22-39
 - vector graphics Glossary-15
 - vector graphics on PCL logical page 2-6
 - Vector Group 17-4, 20-1
 - Vector Group commands summary 20-1
 - when to use HP-GL/2 17-1
- HT, horizontal tab 6-9
- I**
- I/O Glossary-6
 - buffer Glossary-6
 - status response 16-1
 - throughput 24-11
 - ID code, symbol set 10-2, 10-6
 - ID command
 - Font 8-26
 - ID number 9-2
 - font selection 8-26
 - macro 12-3, 12-6
 - ROM-based macros 12-8
 - user-defined pattern 13-16
 - IF (Intellifont Face Data) 11-42
 - Image area (HP-GL/2) 18-2
 - image, raster 15-1
 - importing images (HP-GL/2) 17-25
 - initialization 19-3
 - Initialize (IN) command 17-10, 19-3, 19-15, 19-21
 - Input P1 and P2 (IP) command 19-23, 19-36
 - Input Window (IW) command 17-19, 19-29
 - Inquire Status Readback Entity command 16-10
 - integer 17-10
 - Intellifont
 - coordinate system 11-4
 - font header 11-10, 11-11
 - global data size 11-35
 - scalable character descriptor 11-60
 - Intellifont manual x
 - interface connector Glossary-6
 - interface, throughput 24-11
 - internal fonts 7-2, 7-11, Glossary-7
 - status readback 16-8
 - internal unit 2-5
 - invalid entity, status readback error 16-19
 - invalid location, status readback error 16-19
 - IP command 19-23, 19-36
 - IR command 19-26
 - ISO symbol sets 8-8
 - isotropic scaling 19-4, 19-41, 19-42
 - italic style 7-6
 - IW command 19-29
- J**
- job control
 - commands, PCL 4-1
 - hints 24-3
 - job separation 4-11
- K**
- Kind
 - 1 (symbol set) 23-69
 - 2 (font spacing) 23-70
 - 3 (pitch) 23-70
 - 4 (height) 23-71
 - 5 (posture) 23-71
 - 6 (stroke weight) 23-71
 - 7 (typeface) 23-72
- L**
- LA command 22-2, 22-15
 - label
 - default conditions (HP-GL/2) 23-7

- direction 23-29
- orientation and placement 23-9
- terminator 23-11, 23-44
- text 17-11
- text (HP-GL/2) 23-1, 23-3, 23-8
- Label (LB) command 23-3, 23-59
- Label Origin (LO) command 23-10, 23-62
- labeling, pen movement 23-24
- landscape
 - (defined) Glossary-8
 - character data example 11-73
 - orientation 5-5
 - print boundaries 2-8
- LaserJet
 - customer assistance Customer Support-1
 - printer features v
- last code 10-7
 - font header 11-30
- layers, and transparency mode 22-42
- LB command 23-3, 23-59
 - example 23-60
- Left Margin command 5-13
- Left Offset Registration command 4-7
- left offset, character descriptor 11-56
- legal vs. letter, page selection 24-4
- LF, Line Feed 6-13
- line
 - drawing (HP-GL/2) 20-2
 - ends 22-17
 - fill types 22-1
 - joins 22-17
 - pen widths 22-5
 - screening 22-39
 - segments, four types (HP-GL/2) 19-18
 - thickness 23-21
 - types 22-2
 - types, user-defined 22-44
 - width 23-74
- Line and Fill Attributes Group (HP-GL/2 commands) 17-6, 22-1
- Line Attribute (LA) command 22-2, 22-15
- Line Feed (LF) 6-13, 23-5, 23-16
 - changing distance 23-8
 - specifying direction 23-46
- Line Spacing command 5-24
- Line Termination command 6-13
- Line Type command 22-2, 22-22
- LO command 23-10, 23-62
- location type, status readback 16-3, 16-8
- location unit, status readback 16-3, 16-9
- location, in font selection 8-24
- LOCTYPE= status response 16-11
- LOCUNIT= status response 16-11
- logical page 2-2, 17-19, Glossary-7
 - boundaries 2-7, 2-8

- orientation 7-8, 17-17
- logical pen 20-31
- long edge binding mode 4-5
- lost mode (HP-GL/2) 17-11
- LT command 22-2, 22-22

M

- macro 12-1, 24-8
 - (defined) Glossary-7
 - call 12-4
 - cartridge 12-1
 - cartridge ID number 12-8
 - Control command 12-7
 - creation 12-3
 - custom made 12-1
 - deleting 4-2, 12-5, 12-6, 12-7
 - enabling 12-7
 - entity 16-3
 - execute 12-4
 - HP-GL/2 mode 12-4
 - ID number, assigning 12-3
 - invocation 12-4, 12-7
 - letterhead example 12-9
 - Macro ID command 12-6
 - nesting 12-7
 - overlay 12-4, 12-5, 24-8
 - permanent 12-5, 12-7
 - ROM-based 12-8
 - SIMM 12-1
 - start definition 12-7
 - status readback 16-10, 16-16
 - stop definition 12-7
 - temporary 12-5, 12-7
 - using within another macro 12-7
- Macro Control command 12-7
- Macro ID command 12-6
- macro overlay environment 3-1
- manual, overview v
- manuals, related x
 - !!Intellifont Scalable Typeface Format!! x
 - !!PCL 5 Comparison Guide!! x
 - !!Software Application Notes!! vi
 - !!TrueType Font File Specification!! x
- margins
 - bottom 5-18
 - clearing 5-15
 - left 5-13
 - resetting 5-15
 - right 5-14
 - text area 24-4
 - top 5-16
- master font size 11-4
- Master Symbol List (MSL)
 - !!see also!! MSL 9-11
 - (defined) Glossary-8
- master underline

- position field 11-34
- thickness field 11-34
- master x resolution, pattern descriptor 13-18
- master y resolution, pattern descriptor 13-18
- matching coordinates, HP-GL/2 and PCL 19-15
- measure, unit of Glossary-15
- medium stroke weight 7-6
- memory
 - available 16-21, 16-24
 - entity storage 16-3
 - font usage 7-8, 16-22
 - macro 12-3
 - overflow, avoiding 16-2, 24-15
 - RAM 8-3
 - raster graphics usage 15-6
 - ROM 8-3
 - status readback, free space 16-4
 - user 8-3
- menu Glossary-7
- metric data, Intellifont 11-63, 11-64
- mirror-image 19-8
 - creating 19-12
 - fonts 23-74
- miter limit 22-19
- mnemonic (HP-GL/2 syntax) 17-7
- Mode Enter command, HP-GL/2 18-13
- Mode Enter command, PCL 18-14
- modified print environment 3-1, 3-7, Glossary-7
- MSL
 - and Unicode numbers 9-11
 - character requirements 10-7
 - Master Symbol List (defined) Glossary-8
 - symbol index 11-35, 11-36
 - symbol index example 10-14
 - symbol index numbers 9-11

N

- negative angle of rotation 20-7, Glossary-8
- nesting, macro 12-7
- networking, printer status 16-2
- none, status readback error 16-19
- non-volatile RAM Glossary-8
- non-zero winding fill method for polygons 21-13
- number of characters, font header 11-30
- Number of Copies command 4-4, 19-39

O

- off-line/on-line Glossary-8
- offset, print job 4-11
- one-byte typeface value 11-24
- opaque print model mode 13-3

- OR threshold, font header 11-35
- orientation 7-8, Glossary-8
 - character descriptor 11-56
 - effect on HP-GL/2 17-17
 - font header 11-19
 - fonts 7-8, 8-20
 - HP-GL/2 labels 23-9
 - in font selection 8-25
 - raster graphics 15-8
- Orientation command 5-5
- origin 17-15
- outline font 7-9
- output bin selection command 4-12
- overlay
 - environment 3-1, 12-4, Glossary-8
 - macro 12-4, 12-5
- overview, manual v

P

- P1 and P2 19-4, 19-12, 19-26, 23-81
 - commands affected by, table 19-24, 19-28
 - default location 19-23
 - input command 19-23
 - input relative command 19-26
 - printing beyond 19-45
 - scaling points 17-24
 - specifying location 19-26
 - X,Y Coordinates 19-26
- PA (Panose), format of data segment 11-42
- PA command 17-25, 20-30
- page
 - binding 4-7, 4-8
 - boundaries 2-2, 2-8
 - control 24-4
 - control commands 5-1
 - eject 16-24, 19-33, 19-39
 - format commands 5-1
 - length 24-4
 - orientation 5-5, 7-8
 - Page Size command 5-2
 - page size-independent image 18-3
 - printing boundaries 2-7, 2-8
 - protection 24-10
 - size 24-4
 - size (in PCL Units) 2-7
 - size independent image 18-3
- page size command 5-2
- paper
 - landscape size 2-8
 - output control 4-12
 - portrait size 2-7
 - selection 24-4
 - Source command 5-4, 24-4
- parallel I/O Glossary-9

- parameters
 - formats (HP-GL/2) 17-10
 - HP-GL/2 syntax 17-7
 - scaling 19-45
 - user-units in scaling 19-41
- parentheses 17-9
- parsing, PCL commands 24-2
- Pattern 13-8, 14-5
- pattern
 - black fill 14-9
 - cross-hatch 14-8
 - cross-hatch fill 14-9
 - current 13-2
 - erase fill 14-9
 - fonts 7-11
 - line 13-11
 - raster fill 22-9
 - reference point 13-14
 - shaded fill 14-9
 - shading 13-9, 14-6
 - transparency mode 13-2
 - user-defined Glossary-15
 - user-defined - !!also see!! user-defined pattern 13-13
- Pattern ID (Area Fill ID) command 13-8, 14-5
- Pattern Transparency Mode command 13-7
- PCL
 - adapting to match HP-GL/2 19-15
 - architecture 1-2
 - bitmap fonts 11-51
 - character definition 11-48
 - command processing time 24-10
 - commands 1-3, Glossary-9
 - commands, unsupported 1-2
 - coordinate system 2-1, 2-4, 2-5, 19-15
 - coordinate system, width and height 14-2
 - coordination system units Glossary-9
 - default settings 3-2
 - Enter PCL Mode command 18-14
 - escape sequences 1-3
 - history 1-1
 - job control commands 4-1
 - levels 1-2
 - macro overlay environment 12-4, 12-5
 - matching HP-GL/2 coordinates 17-17, 19-15
 - page control 24-4
 - PCL point vs. typographic point 2-5
 - PCL Units vs. printed dots 2-3, 2-5
 - point 7-5
 - print model 13-1
 - printer program language 1-1
 - printer reset command 4-2
 - status readback !!see also!! status readback 16-1
 - unit of measure for cursor movements 4-13
 - units 6-3, Glossary-9
- PCL picture frame 17-19, 18-1
 - adjusting image size (scaling) 18-3
 - anchor point 18-1
 - boundaries 19-6
 - creating a simple drawing, example 18-16
 - example 18-6
 - scaling 18-3
 - scaling factor 18-1
 - Set Anchor Point command 18-10
 - size (horizontal) 18-8
 - size (vertical) 18-9
- PCL/HP-GL/2 orientation interactions 17-17
- PD command 17-21, 20-2, 20-31
- PE command 20-34
 - example 20-41
- pen
 - absolute vs. relative movement 17-25
 - automatic pen down 17-21
 - location 17-21, 17-23, 19-35, 23-5
 - movement for labeling 23-24
 - selection 22-5, 22-38
 - status 17-21
 - width 22-30
 - width unit selection 22-46
- Pen Down (PD) command 17-21, 20-2, 20-31
 - example 20-32
- Pen Up (PU) command 17-22, 20-46
- Pen Width (PW) command 22-5, 22-29, 23-21
- perforation
 - .region Glossary-9
 - region 5-11, 5-19
 - skip 5-11
- Perforation Skip command 5-19
- performance, printer 24-10
- permanent fonts 9-3, 9-5
 - status readback 16-8
- permanent macros 12-5
- PF (PS-Compatible Font Name) 11-42
- PG command 19-33
- phone support, HP Customer Support-2
- physical coordinate system 11-4
- physical page
 - (defined) 2-7
 - size (in PCL Units), landscape 2-8
 - size (in PCL Units), portrait 2-7
- picture frame 18-1
 - anchor point 17-17

- HP-GL/2 2-6
- size (vertical) 18-9
- picture presentation directives 18-1
- pie charts 21-27, 21-45
- pitch 7-5, 23-70, 23-73, Glossary-10
 - computing 8-11
 - extended, font header 11-30
 - font header 11-21
 - font selection command 8-10
 - in font selection 8-23
 - selections, range of valid 8-10
- pixel 22-33
- pixel encoding, user-defined pattern
 - descriptor 13-17
- pixel level clipping 2-8
- PJL Glossary-10
- PJL commands 1-4
- placement, font header 11-28
- placing text 23-10
- Plot Absolute command 17-25, 20-30
- Plot Relative command 20-44
- plot size (horizontal) 18-11
- plot size (vertical) 18-12
- plotter units (plu) 17-11, 17-20
- PM command 21-10, 21-34
 - example 21-37
- PM1 and PM2 21-36, 21-37
- point Glossary-10
- point size
 - (defined) 2-5
 - (HP-GL/2) 23-71
 - bitmap 8-12, 8-13
 - PCL 7-5
 - scalable fonts 8-12
 - TrueType 8-12
- point-factor scaling 19-4, 19-41, 19-44
- polygon
 - (drawing in HP-GL/2 mode) 21-10
 - buffer 21-1, 21-2
 - buffer use 21-14
 - counting points in 21-15
 - definition commands summary 21-10
 - drawing circles in polygon mode 21-14
 - filling 21-12
 - mode 21-1, 21-10
 - Polygon Group HP-GL/2 commands 21-1
 - Polygon Group (HP-GL/2 commands) 17-4
 - Polygon Mode (PM) command 21-34
 - Polyline Encoded (PE) command 20-34
- pop cursor positioning 6-14
- portrait
 - (defined) Glossary-8
 - character data example 11-71
 - orientation 5-5
 - print boundaries 2-7
 - position (orientation) of logical page 7-8
 - position, rectangular area 14-10
 - positioning
 - cursor 2-2
 - cursor (defined) Glossary-1
 - page data 6-1
 - text 23-24
 - positive angle of rotation 20-7, Glossary-10
 - posture (HP-GL/2) 23-71
 - PR command 20-44
 - predefined shading/patterns 14-1
 - primary font 8-5, Glossary-10
 - HP-GL/2 23-85
 - print boundaries 2-7, 2-8
 - print data processing time 24-10
 - print direction 17-17
 - Print Direction command 5-9
 - print environment 3-1
 - (defined) Glossary-11
 - factory default 3-5
 - HP-GL/2 19-3
 - modified 3-7
 - print job separation 4-11
 - print model 13-1, 13-2
 - command sequence 13-5
 - current pattern 13-2
 - destination image 13-1, 13-2
 - opaque mode 13-3
 - pattern 13-2
 - pattern ID (area fill ID) command 13-8
 - pattern transparency mode 13-1, 13-2, 13-7
 - rectangular areas, pattern ID command 13-8
 - Select Current Pattern command 13-12
 - source image 13-1, 13-2
 - source transparency mode 13-1, 13-2, 13-6
 - transparent mode 13-3
 - print overrun 24-10
 - print overrun ('`ERROR 21')' 24-15
 - print resolution
 - default 2-3
 - described 2-3
 - specifying 2-3
 - printable
 - area 2-7
 - area (defined) Glossary-10
 - area (raster graphics) 15-5
 - area boundaries 2-7, 2-8
 - area clipping 2-8
 - area limits, HP-GL/2 17-19
 - character codes 11-15
 - character range 11-30

- characters 24-13
- control codes 24-13
- printed dots 2-3
- printer
 - commands (defined) Glossary-11
 - internal units 2-5
 - performance/speed 24-10
 - program language 1-1
 - resets 3-8
- printer commands
 - combining 1-8
 - shortening 1-8
- Printer Job Language (PJM) commands 1-4
- Printer Reset command 4-2
- printing
 - a character 9-13
 - control codes 8-28, 23-86, 24-12
 - different characters 7-1
 - duplex 4-5
 - fixed-spaced fonts 23-15
 - labels 23-3
 - menu (defined) Glossary-11
 - patterns/shading 7-11
 - processing time 24-10
 - proportional fonts 23-15
 - raster graphic resolution 15-6
 - simplex 4-5
 - text at an angle 23-29, 23-31
 - text in HP-GL/2 mode 23-1
 - text with LB command 23-59, 23-60
- printing menu Glossary-11
- printing patterns/shading 13-8
- priority
 - characteristics 8-1
 - font location 8-24
- programming
 - errors, common 24-15
 - hints 24-1
 - languages with HP-GL/2 17-13
 - status readback 16-27
- proportion, maintaining in scaled plots 19-8
- proportional fonts 23-13, 23-15, 23-73 (HP-GL/2) 23-74
 - defined 7-4
- proportional spacing 8-9
- proportional spacing, font selection 8-23
- PU command 20-46
- Push/Pop Cursor Positioning command 6-14
- PW command 22-5, 22-29, 23-21

Q

- quality, font header 11-28

R

- RA command 21-4, 21-39
- radius, in drawing arcs 21-28
- RAM fonts 7-2, 8-3
- Raster Fill Definition (RF) 22-32
- raster graphics 15-1, 15-5
 - (defined) Glossary-11
 - adaptive compression 15-25
 - binary data 15-1
 - clipping 15-11
 - command sequence 15-4
 - compression 15-16, 15-23, Glossary-2
 - compression (example) 15-19, 15-24
 - compression, coding efficiency 15-19
 - compression, TIFF Encoding 15-17
 - compression, byte counts 15-29
 - data block 15-25
 - data compressions/reduction 15-13
 - delta row compression 15-16, 15-20
 - End command 15-30
 - example 15-31
 - Height command 15-11
 - image 15-1
 - left margin 15-14
 - memory usage 15-6
 - orientation 15-8
 - presentation 15-14
 - Presentation command 15-8
 - presentation mode 15-15, 24-7
 - printable area 15-5
 - printing zeroed row 15-23
 - raster area 15-2
 - raster area height 15-11
 - raster fill 22-9
 - Raster Fill Definition (RF) 22-32
 - Raster Y Offset command 15-15
 - repeating row 15-23
 - resolution 15-14, 15-15, 24-7
 - Resolution command 15-6
 - run-length data compression 15-16
 - seed row 15-22
 - Set Compression Method command 15-16
 - Start command 15-14
 - Termination command 15-30
 - termination implied 15-15
 - throughput 24-7
 - TIFF data compression 15-16
 - Transfer Raster Data command 15-29
 - vs. HP-GL/2 graphics, when to use 17-1
 - Width command 15-13
 - zeroed rows 15-2
- Raster Height command 15-11
- raster image 15-1
- Raster Width command 15-13
- Raster Y Offset command 15-15

real number 17-10
 rectangle
 drawing (HP-GL/2 mode) 21-3
 effect of transparency mode 14-11
 fill 14-1
 fill (examples) 14-13
 fill (transparency mode) 14-11
 Fill command 14-9
 fill procedure 14-1
 Horizontal Size command 14-3
 pattern transparency mode 14-2
 position 14-10
 rectangular area definition 14-1
 transparency mode 14-10
 Vertical Size command 14-4
 reducing/enlarging HP-GL/2 images 19-8
 registration
 text 4-7
 Top Offset command 4-8
 related manuals x
 !!Intellifont Scalable Typeface Format!! x
 !!PCL 5 Comparison Guide!! x
 !!Software Application Notes!! vi
 !!TrueType Font File Specification!! x
 Relative Arc Three Point command 20-48
 Relative Character Size command 23-8,
 23-14, 23-81
 relative cursor positioning 6-2, 24-5
 Relative Direction command 23-9, 23-21,
 23-37
 relative vs. absolute pen movement 17-25
 Replot command 19-39
 reset 24-3, Glossary-11
 cold 3-9
 key 3-8
 margins 5-15
 printer 3-8
 Reset command 19-3
 resetting environments 3-8
 resolution 14-2
 (defined) Glossary-12
 defined 2-3
 fonts 8-5
 print (default) 2-3
 raster graphics printing 15-6
 response, status !!see also!! status
 readback 16-11, 16-22
 reverse landscape orientation 5-5
 reverse portrait orientation 5-5
 RF command 22-32
 Right Margin command 5-14
 RO command 17-17, 19-24, 19-34
 RO command 19-28
 robust-Xon Glossary-12
 ROM-based
 font 7-2, 8-3
 macros 12-8
 Rotate Coordinate System (RO) command
 17-17, 19-24, 19-28, 19-34
 rotation, fonts 7-8
 row Glossary-12
 row height 5-22
 rows and columns 2-5, 6-4
 rows, zeroed (in raster graphics) 15-2
 RP command 19-39
 RR command 21-4, 21-42
 RT command 20-7, 20-48
 example 20-49
 rule Glossary-12
 black 13-12
 white 13-12
 run and rise, measuring 23-31
 run-length
 adaptive compression 15-25
 encoding, character data 11-54
 raster graphics compression 15-16

S

SA command 23-66
 SB command 23-31, 23-67
 SC command 17-20, 17-24, 19-4, 19-15,
 19-40
 SC, possible error conditions, (table)
 19-46
 scalable
 (defined) Glossary-12
 bound font header 11-10
 character descriptor 11-62
 compound character 11-62
 fonts 7-2, 7-9, 11-2, 23-20
 fonts, status readback 16-12
 typeface 7-9
 unbound font - !!also see!! unbound font
 9-8
 unbound font header 11-11
 Scalable or Bitmap Fonts command 23-31,
 23-67
 Scale command 17-20, 17-24, 19-4,
 19-15, 19-40
 scale factor, font header 11-34
 scaling 17-24
 effect on current units 17-11
 parameters 19-45
 picture frame scaling factor 18-1
 points (P1 and P2) 17-24, 19-4
 possible error conditions for SC, (table)
 19-46
 type 0 (anisotropic) 19-41
 type 1 (isotropic) 19-41
 type two (point-factor) 19-44
 types 19-4, 19-40
 user-units 17-20

- user-units (pictured) 19-5
- Screened Vectors command 22-39
- screening (area fill) 22-39
- SD command 23-68
 - example 23-73
- secondary font 8-5, Glossary-10
 - HP-GL/2 23-56
 - HP-GL/2) 23-18
- secured paper source 24-4
- seed row 15-20, 15-22
 - adaptive compression 15-27
 - raster graphic termination 15-15
- segment identifier, Format 15 11-40
- segment size, Format 15 font header 11-41
- segmented font data, Format 15 11-39
- Select Alternate Font command 23-66
- Select Current Pattern command 13-12
- Select Default Font command 8-27
- Select Pen (SP) command 22-5, 22-38
- Select Primary Font command 23-54
- Select Secondary Font command 23-56
- Select Standard Font command 23-85
- SELECT= status response 16-11
- semicolon 17-9
- separators (HP-GL/2 syntax) 17-7
- serial I/O Glossary-13
- serif style, font header 11-27
- Set Compression Method command 15-16
- Set Pattern Reference Point command 13-13, 13-22
- Set Picture Frame Anchor Point command 18-10
- Set Status Readback Location Type command 16-8
- Set Status Readback Location Unit command 16-9
- shaded fill 22-11
 - fonts 7-11
 - FT command 22-9
 - pattern selection 13-8, 14-5
 - patterns 13-9, 14-6, 14-9
- Shift In (SI) 8-5, 23-8
- Shift Out (SO) 8-5, 23-8, 23-66
- short-edge binding mode 4-5
- shortening commands 1-8
- SI (Shift In) 8-5
- SI command 23-8, 23-14, 23-74
 - example 23-75
- signed byte (SB) 10-5, 11-14
 - character descriptor 11-51
- signed integer (SI) 10-5, 11-14
- signed long integer (SLI) 10-5, 11-14
- SIMM
 - fonts 7-2
 - macro, storing 12-1
- simplex printing 4-5
- simplex/duplex print command 4-5
- size
 - HP-GL/2 drawing 19-9
- SL command 23-8, 23-78
 - example 23-79
- slant, character 23-8, 23-78
- SM command 22-35
- SO (Shift Out) 8-5
- soft font Glossary-13
- soft fonts 7-2
 - creation 11-1
 - status readback 16-13
- soft symbol sets 10-12
- soft-clip window 17-19, 18-8, 18-10, 18-15, 19-18, 19-29, 19-35, 19-37, 20-20, 20-22
- solid fill 22-9
- source image 13-1, 13-2
- source transparency mode 13-2
- Source Transparency Mode command 13-6
- SP command 22-5, 22-38
- SP, Space 6-7
- Space (SP) control code 6-7
- Space character 5-20
- spacing 7-4, Glossary-13
 - character 8-9, 24-4, 24-5
 - font header 11-20
 - font selection command 8-9, 8-23
- HP-GL/2 23-70
- special effects, fonts 7-11
- specifications, page boundaries 2-7, 2-8
- SR command 23-8, 23-14, 23-81
 - example 23-83
- SS command 23-85
- Standard Font Definition command 23-68
- standard vs. alternate fonts, HP-GL/2 23-17
- start angle 21-6
- Start Raster Graphics command 15-14
- status readback 16-1
 - bitmap fonts 16-12
 - clearing status 16-5
 - currently selected 16-3
 - DEFID= 16-15
 - Echo command 16-25
 - entity 16-3
 - entity request, example 16-4
 - entity response 16-11
 - error - entity 16-11
 - error - location type 16-8
 - error codes, entity 16-19
 - Error=INVALID ENTITY 16-19
 - Error=INVALID LOCATION 16-19

- Error=INVALID UNIT 16-23
- Error=NONE 16-20
- Flush All Pages command 16-24
- font extended 16-10
- font status 16-10
- Free Space command 16-21
- IDLIST= 16-16, 16-17, 16-18
- inquire entity command 16-10
- LARGEST= 16-22
- location type 16-3
- location unit 16-3
- LOCTYPE= 16-14, 16-17
- LOCUNIT= 16-14, 16-17
- macro status 16-10
- memory 16-2
- memory response 16-22
- NAME= 16-16
- response 16-5
- response buffer 16-5
- response syntax 16-6
- response, font 16-11
- response, font extended 16-15
- response, macro 16-16
- response, symbol set 16-18
- response, user-defined pattern 16-17
- scalable fonts 16-12
- SELECT= 16-11
- Set Status Readback Location Type command 16-8
- Set Status Readback Location Unit command 16-9
- soft fonts 16-13
- symbol set status 16-10
- SYMBOLSETS= 16-13
- TOTAL= 16-22
- unbound scalable fonts 16-13
- user identification 16-25
- user-defined pattern status 16-10
- status readback error, internal 16-19
- Stick font 23-74
- Stick/Arc fonts 23-15
- stroke weight 7-6
 - (defined) Glossary-13
 - font header 11-23
 - Font Selection command 8-16
 - HP-GL/2 23-71
 - in font selection 8-24
 - table 8-16
- style Glossary-13
 - defining characteristics 7-6
 - font 7-6
 - font header 11-23
 - font selection, command 8-14
 - fonts, (pictured) 8-15
 - in font selection 8-24
 - italic (pictured) 7-6
 - MSB, font header 11-16
 - upright (pictured) 7-6
 - values table 8-14
 - style word 11-16
 - subpolygons 21-11
 - summaries, chapter vi
 - support, HP customer assistance
 - Customer Support-1
 - SV command 22-39
 - sweep angle 21-6
 - in wedges 21-28
 - symbol collection 9-9, 10-7
 - symbol index Glossary-13
 - examples 10-13, 10-14
 - number 10-11
 - numbers and character codes 9-11
 - symbol map 10-11
 - symbol mode 20-44, 20-47
 - Symbol Mode (SM) command 22-35
 - symbol set 7-2
 - (defined) Glossary-14
 - 7-bit ISO 8-7
 - entity 16-3
 - font header 11-20
 - Font Selection command 8-6
 - font selection command 8-23
 - HP-GL/2 23-69
 - ID code 10-6
 - ID Code command 10-2
 - ID selection value 10-2, 10-6
 - ISO 8-8
 - mapping table 9-12
 - status readback 16-10, 16-18
 - user-defined 8-7
 - user-defined - !also see!! user-defined
 - symbol set 10-1
 - user-defined (definition) Glossary-15
 - user-defined (soft) control 10-12
 - user-defined symbol set header 10-6
 - value, calculating 11-20
 - Symbol Set command 8-6
 - Symbol Set ID Code command 10-2
 - SYMBOLSETS= status response 16-11
 - syntax
 - HP-GL/2 17-6
 - status readback 16-6

T

- Tagged Image File Format (TIFF)
 - Encoding (raster compression) 15-17
- TD command 23-86
- technical support line, HP Customer Support-2
- temporary fonts 9-5
 - soft 9-3

- status readback 16-8
- temporary macros 12-5
- terminating labels 23-11
- termination character 1-6
- terminator (HP-GL/2 syntax) 17-7
- text
 - angle, varying with DI 23-9
 - area 5-11, 5-18, 24-4
 - character positioning (HP-GL/2) 23-62
 - first line 5-16
 - height, font header 11-29
 - length 24-4
 - length, computing user default 5-18
 - orienting and placing 23-10
 - path 23-46
 - placing HP-GL/2 23-9
 - positioning 4-7, 4-8
 - printing 5-11
 - printing (HP-GL/2) 23-59
 - Text Length command 5-18
 - width, font header 11-29
- thickness, character 8-16
- TIFF
 - adaptive compression 15-25, 15-27
 - raster graphics compression 15-16
- top margin 24-4
- Top Margin command 5-16
- Top Offset Registration command 4-8
- top offset, character descriptor 11-56
- TR command 22-38, 22-42
- Transfer Raster Data command 15-25, 15-29
- transparency mode 13-1
 - effect on rectangular areas 14-11
 - example 13-4
 - pattern 13-2, 13-7
 - rectangular area 14-10
 - source 13-2, 13-6
- Transparency Mode (TR) command 22-38, 22-42
- Transparent Data command 23-86
- Transparent Print Data command 8-28, 24-6
- transparent print model mode 13-3
- tray, output 4-12
- treatment Glossary-14
- tree data, Intellifont character descriptor 11-64
- tree offset, Intellifont character descriptor 11-64
- troubleshooting (auto-continue mode) 24-14
- Troubleshooting command 24-12
- TrueType
 - data segment 11-41
 - font header 11-13
 - fonts, character coordinates 11-5
 - glyph data 11-69
 - glyphs, downloading 11-49
 - scalable fonts 11-3
- two-byte typeface value 11-24
- type
 - location status readback 16-3
 - user-defined symbol set header 10-6
- typeface 7-7, Glossary-14
 - base value 11-27
 - family value 11-27
 - font header 11-24
 - font header, previous usage 11-26
 - font selection, Family command 8-18
 - HP-GL/2 23-72
 - in font selection 8-24
 - internal 7-2
 - one-byte value 11-24
 - two-byte value 11-24
- Typeface Family command 8-18
- typographic point
 - vs. PCL decipoint 6-4
 - vs. PCL point 2-5

U

- UEL (Universal Exit Language) Glossary-14
- UL command 22-44
- unbound font 16-13, Glossary-1
 - character complement 10-7
 - character complement numbers 9-10
 - character requirements number 9-10
 - creation 9-8
 - downloading 9-8
 - scalable - !!also see!! unbound font 9-8
 - scalable fonts and user-defined symbol sets 10-1
 - selection 9-8
 - status readback 16-13
 - symbol collections 9-9
 - symbol set mapping 9-11
 - typeface 9-8
- underline
 - fixed 8-29
 - floating 8-29
 - position (distance), font header 11-29
 - thickness, font header 11-29
- Underline command 8-29
- unencoded, adaptive compression 15-25
- Unicode Glossary-14
 - and MSL numbers 9-11
 - character requirements 10-9
 - symbol index (example) 10-13, 10-14
 - unit of measure Glossary-15
- Unit Of Measure command 4-13
- unit, location status readback 16-3

- units
 - coordinate system 6-3
 - cursor positioning 6-3
 - design window 11-4
 - internal printer 2-5
 - of measure (HP-GL/2) 17-20
 - PCL coordinate system 2-5
- Universal Exit Language (UEL)
 - Glossary-14
- Universal Exit Language command 4-3
- unsigned byte (UB) 10-5, 11-14
 - character descriptor 11-51
- unsigned integer (UI) 10-5, 11-14
 - character descriptor 11-51
- unsigned long integer (ULI) 10-5, 11-14
- upright style 7-6
- user default Glossary-15
 - computing text length 5-18
 - environment 3-1, Glossary-15
 - environment (settings) 3-6
 - symbol set 8-6
- user memory 8-3
- user-defined
 - fill definition (raster) 22-32
 - fill patterns 14-9, 22-13
 - fill types, HP-GL/2 22-4
 - fonts naming (ASC16) 11-33
 - symbol set 8-7
- User-Defined Line Type command 22-44
- user-defined pattern
 - !!introduction!! 13-13
 - (defined) Glossary-15
 - assign ID 13-8, 14-5
 - base pattern 13-13
 - data 13-18
 - data - !!see also!! descriptor 13-16
 - define pattern command 13-16
 - deleting 13-23
 - descriptor format (header) 13-16
 - entity 16-3
 - example 13-19
 - fill (example) 14-17
 - header fields - !!see also!! user-defined
 - pattern descriptor fields 13-16
 - ID number 13-16
 - Pattern Control command 13-23
 - Pattern ID command 13-8, 14-5
 - permanent 13-23
 - reference point 13-14
 - selecting ID 13-8, 14-5
 - Set Pattern Reference Point command
 - 13-22
 - status readback 16-10, 16-17
 - temporary 13-23
- User-Defined Pattern command 13-16
- user-defined symbol set
 - !!introduction!! 10-1
 - (defined) Glossary-15
 - characters and character mapping 10-4
 - control command 10-12
 - creating 10-2
 - data/symbol set format (pictured) 10-4
 - defining/designing 10-1
 - definition command 10-4
 - encoded symbol set designator 10-6
 - examples 10-13
 - headers 10-4
 - ID code 10-6
 - ID Code command 10-2
 - used with unbound scalable fonts 10-1
- user-units 17-11, 17-20
 - creating 17-24
 - in scaling, parameters 19-41
 - scaling 19-5, 19-40
 - X- and Y-axis ranges in scaling,
 - parameters 19-41

V

- value field (PCL command) 1-6
- values allowed (HP-GL/2) 17-10
- variety, font header 11-35
- vector fill 22-39
- vector graphics Glossary-15
- vector graphics limits 17-19
- Vector Group (HP-GL/2) 20-1
 - commands 17-4
- vendor-version, font header typeface
 - 11-24, 11-26
- vertical
 - character spacing 8-12
 - cursor positioning control codes 6-13
 - text path 23-26
- Vertical Cursor Positioning command
 - decipoints 6-11
 - PCL Units 6-12
 - rows 6-9
- Vertical Motion Index (VMI) 2-5, 6-3
 - command 5-22
- vertical motion index (VMI) Glossary-16
- Vertical Picture Frame Size (Decipoints)
 - command 18-9
- Vertical Rectangle Size command
 - decipoints 14-4
 - PCL Units 14-4
- VMI
 - common settings 5-23
 - designating and computing (example)
 - 5-22
- VMI command 5-22

W

- wedges (drawing in HP-GL/2 mode) 21-6

wedges and circles, filling (example) 21-8
 WG command 21-6, 21-27, 21-45
 white fill 14-9, 14-10
 white rule 13-12
 width
 character descriptor 11-57
 lines 22-5
 pixel, user-defined pattern descriptor
 13-18
 type (font header) 11-23
 windowing 19-18
 WU command 22-46

X
 X resolution, font header 11-33
 X,Y
 axis ranges, user-units in scaling 19-41
 coordinate pairs 17-16
 X-axis 17-15
 PCL coordinate system 2-5
 units 6-3

xHeight, font header 11-22
 XW (x-windows font name), format of data
 segment 11-42
 XY
 coordinate data, character descriptor
 11-64
 data offset, character descriptor 11-64

Y
 Y - Display Functions, Enable 24-12
 Y resolution, font header 11-34
 Y-axis 17-15
 PCL coordinate system 2-5
 units 6-3
 Y-offset, adaptive compression 15-27

Z
 Z - Display Functions, Disable 24-12
 zero-degree reference 21-6
 zeroed rows (in raster graphics) 15-2



**Copyright© 1999
Hewlett-Packard Co.**