

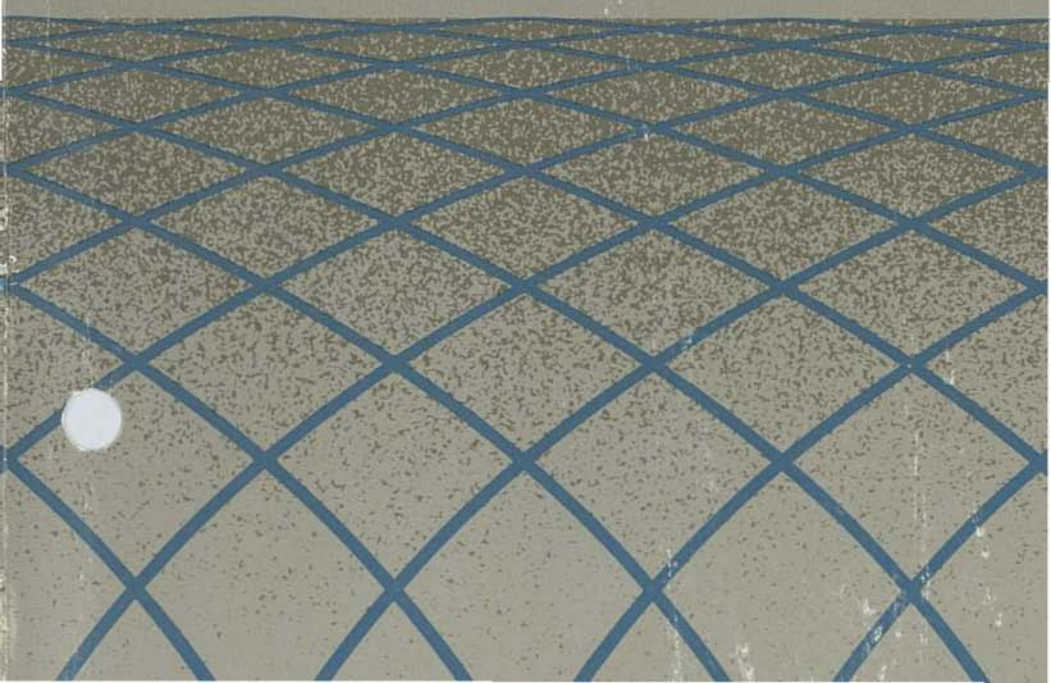

AT&T

StarLAN 10 Network

Hub Unit
Installation Guide



©1990 AT&T
All Rights Reserved
Printed In USA

NOTICE

The information in this document is subject to change without notice. AT&T assumes no responsibility for any errors that may appear in this document.

TRADEMARK NOTICE

StarGROUP is a trademark of AT&T.

WARNING: RISK OF ELECTRICAL SHOCK. EQUIPMENT MUST BE PROPERLY GROUNDED.

Your AT&T equipment requires a properly grounded 3-prong AC power receptacle for safe operation. You should have your receptacle checked by a qualified electrician before connecting this equipment. Do not cut or remove the third (ground) prong from the AT&T power cord. Do not use 2 wire extension cords or adapters to defeat the safety features of your equipment. If you have a 2-prong receptacle, it is very important to have it replaced with a 3-prong receptacle, installed by a qualified electrician.

WARNING

The equipment described here generates, uses, and can radiate radio frequency energy and, if not installed and used in accordance with the installation manual, may cause interference to radio communications. The equipment has been tested and found to comply with the limits for a Class A computing device pursuant to Subpart J of Part 15 of FCC Rules, which are designed to provide reasonable protection against such interference when operated in a commercial environment. Operation of this equipment in a residential area is likely to cause interference to radio communications, in which case the user at his or her own expense will be required to correct this interference.

This digital apparatus does not exceed the Class A limits for radio noise emissions set out in the radio interference regulations of the Canadian Department of Communications.

Le présent appareil numérique n'émet pas de bruits radioélectriques dépassant les limites applicables aux appareils numériques de la classe A prescrites dans le Règlement sur le brouillage radioélectrique édicté par le ministère des Communications du Canada.

TO ORDER ADDITIONAL COPIES OF THIS DOCUMENT

Contact: Your AT&T Account Team

or

AT&T Customer Information Center, Commercial Sales
P.O. Box 19901
Indianapolis, Indiana 46219

In the U.S. call 1-800-432-6600
Outside the U.S. call 1-317-352-8557

Order: Document No. 999-100-722

UPDATES

AT&T can automatically provide you with updates to any StarLAN 10 Network document. If you wish to be included on the update list, call the AT&T Customer Information Center (CIC), ask to be placed on standing order, and indicate the documents by document number. The document updates will be shipped to you as they are stocked by CIC.

Contents

About the Hub	1
Features of the Hub	3
What's In This Guide?	7
To Contact AT&T	9

Before You Install a Hub	11
Design Considerations	11
What's Supplied in a Hub Unit Kit?	14
What Else Do You Need?	16

Network Configurations	19
Hub Locations	20
Sample Network Configurations	21
Distance Guidelines for Connections to a Hub	30

Hub Placement	31
Placement Considerations	32
How to Mount a Hub	36
Power-Up LED Test	41
How to Label Hubs	45

Making Connections to a Hub	47
General Connection Rules	47
Connections to a Hub in a Room	51
Connections to a Hub in a Wiring Closet	57
Hub-to-Hub Connection Between Wiring Closets	66

Verifying Connections to the Hub	77
---	----

Interpreting Hub LEDs	79
Traffic LED	82
Collision LED	84
AUI Jab LED	86
Link/Jab LEDs	88

Hub Pin Assignments	91
----------------------------	----

Glossary	93
-----------------	----

Index	99
--------------	----

About the Hub

A StarLAN 10 Network is a 10 Mbits/second CSMA/CD local area network (LAN) that utilizes unshielded twisted-pair wire, transceiver (AUI) cable, and optical fiber to transmit network signals between hardware devices.

The Hub is a hardware device that enables you to directly connect up to 12 devices (including other Hubs), using twisted-pair wire modular cords (11 devices) and transceiver cable (1 device), in a star configuration to form a StarLAN 10 Network.

In addition to connecting StarLAN 10 Network devices to the Hub, you can connect IEEE Standard 802.3 10BASE5, Ethernet Version 2.0, and 10BASE2 Cheapernet DCE devices such as coaxial, broadband, and optical fiber transceivers, as shown in Figure 1.

The Hub was developed with knowledge of and participation in the standard-setting process of IEEE 10BASE-T task force, whose charge is the development of standard specifications for ANSI/IEEE 802.3 LANs that can use unshielded twisted-pair wire to carry 10 Mbits/sec network signals.

For information on the ANSI/IEEE Standard for Local Area Networks 802.3, read the *Carrier Sense Multiple Access with Collision Detection (CSMA/CD) Manual and Supplement* published by the IEEE (Institute of Electrical and Electronics Engineers, Inc.).

FIGURE 1 Hubs in a StarLAN 10 Network

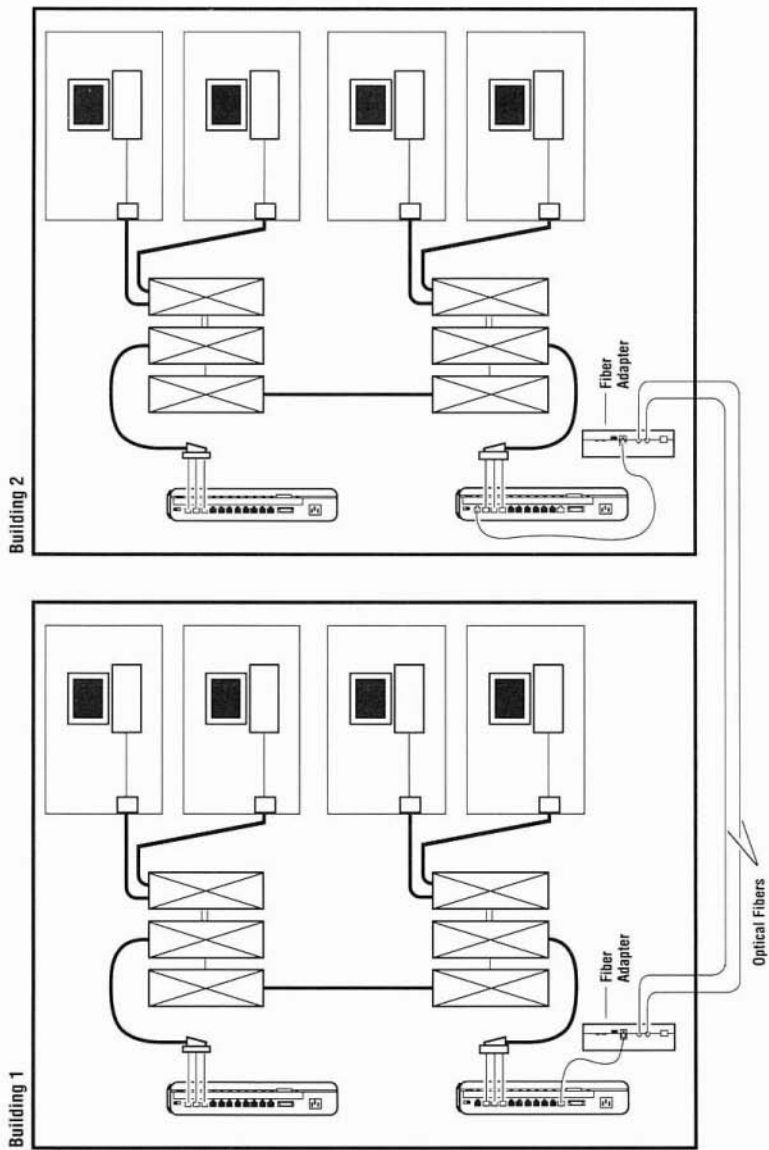

Features of the Hub

The Hub performs the following functions:

- **Distributes Network Signals**

The Hub allows you to connect up to 12 devices that are capable of transmitting and receiving network signals. Each Hub has 10 modular IN jacks (labeled "2" through "11"), a switchable IN/OUT modular jack (labeled "1"), and an Attachment Unit Interface (AUI) port (labeled "AUI"). All of these connectors are conveniently located on the front of the Hub, as shown in Figure 2.

The IN jacks are used to connect StarLAN 10 Network hardware devices via modular cords. The switchable IN/OUT jack when set to the OUT position is used to interconnect Hubs via modular cords. The AUI port accepts a DCE D-type connector to connect Ethernet-compatible devices (transceivers) either directly or via transceiver (AUI) cable.

- **Permits Network Expansion**

Hubs can be interconnected using twisted-pair wire modular cords or via an alternate medium (that is, coaxial, broadband, or optical fiber).

- **Permits Prewiring for Future Nodes**

The Hub's IN jacks can be prewired to wall jacks at locations where nodes will be installed at a later date. This feature also allows nodes to be disconnected from, and reconnected to, wall jacks at any time without affecting the network.

FIGURE 2 Hub Components

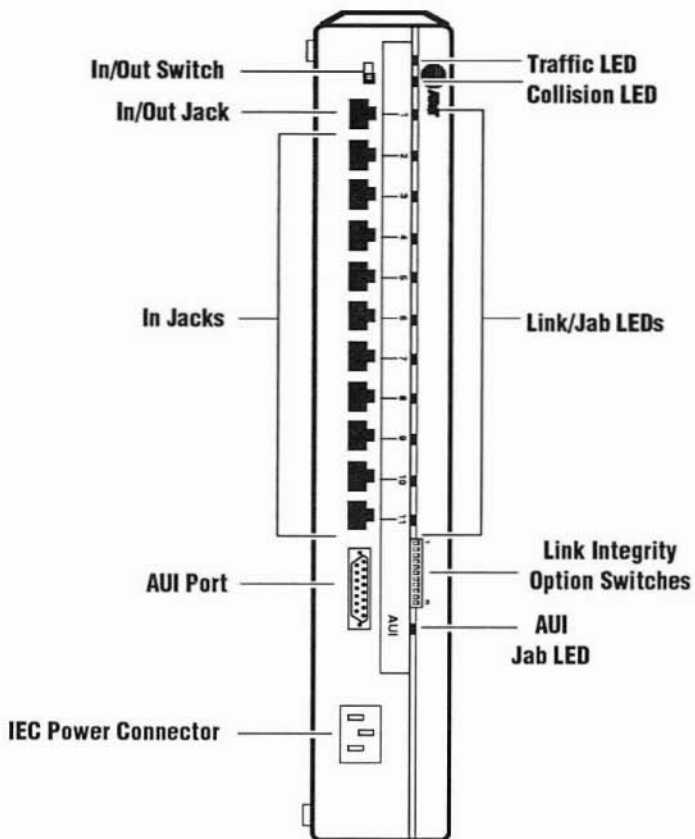

- **Implements the IEEE Standard 802.3 Multiport Repeater Specification**

- **Regenerates Network Signals**

The Hub regenerates network signals by retiming received data frames and regenerating them with the proper amplitude and pulse shape.

- **Isolates Jab Conditions**

The advanced circuitry in the Hub isolates and prevents excessive consecutive collisions (collision storms) and continuous transmissions (jabber) caused by faulty nodes or wiring connections. If a collision storm or jabber condition is detected at a connector on the Hub, that connector is deactivated (jabbed), while the remainder of the network is undisturbed. The jabbed connector is reactivated automatically when the condition that caused the port to be isolated has been corrected. Each port on the Hub has a corresponding LED which is capable of indicating a jab condition. For more information on jab conditions, see "AUI Jab LED" and "Link/Jab LEDs" in the "Interpreting Hub LEDs" section later in this guide.

- **Detects and Displays Network Traffic and Collisions**

The Hub detects the presence of network traffic and collisions. The Hub's traffic and collision LEDs are useful troubleshooting aids. For more information on traffic and collisions, see "Traffic LED" and "Collision LED" in the "Interpreting Hub LEDs" section later in this guide.

- **Verifies Link Integrity**

The Hub's Link Integrity feature can verify the integrity of the receive portion of the twisted-pair wire connection between each modular jack on the Hub and the twisted-pair device connected to that jack. This feature can be disabled on an individual jack basis to provide compatibility with devices that do not support Link Integrity. To enable or disable Link Integrity, use the Link Integrity option switch (as described in the general connection rules in "Making Connections to a Hub" later in this guide). There is one switch that corresponds to each modular jack (11 switches and 11 modular jacks).

► **Important**

The Link Integrity function of devices at both ends of the twisted-pair wire connection must agree. For example, if a jack on the Hub is connected via twisted-pair wire to a device that has Link Integrity enabled, Link Integrity must also be enabled on the Hub for that jack on the Hub. You must disable the Link Integrity on the Hub if the device connected to the modular jack is either not equipped with Link Integrity or has its Link Integrity disabled. ◀

What's In This Guide?

This guide explains how to install and troubleshoot the Hub. It contains the following sections:

- **Before You Install a Hub**

This section explains what you receive in a Hub Unit Kit and what additional hardware you need in order to install the Hub in your wiring environment. It also discusses the design of your StarLAN 10 Network.

- **Network Configurations**

This section explains the basic StarLAN 10 Network configurations that are possible using Hubs. It also provides illustrations of sample Hub configurations. In addition, this section provides a table of maximum distances between the Hub and compatible components.

- **Hub Placement**

This section describes environmental, electrical, and space requirements for the Hub. It also includes a procedure for testing the Hub's LEDs, and step-by-step procedures for mounting and labeling Hubs.

- **Making Connections to a Hub**

This section describes how to connect Hubs in a room or a wiring closet using a variety of connection media.

- **Verifying Connections to the Hub**

This section provides a procedure for verifying that the connections to the Hub's AUI port and modular jacks are good.

- **Interpreting Hub LEDs**

This section describes how to use the Hub's LEDs to detect and isolate network problems.

- **Hub Pin Assignments**

This section provides pin assignments for modular jacks and the AUI port on the Hub. This information is helpful in troubleshooting networks comprised of equipment that has pin assignments different from those used in AT&T equipment.

- **Glossary**

This section explains technical terms for readers who are unfamiliar with communications wiring environments and local area networks.

To Contact AT&T

For Help with Hub Problems

If you have a problem with your Hub, contact your network administrator. If the problem persists, your network administrator can call a representative at the original place of purchase. If you purchased the Hub from AT&T, have your network administrator call the AT&T National System Support Center hotline:

- In the United States and Puerto Rico, dial 1-800-922-0354.
- In Canada, dial 1-800-245-2480.
- In all other countries, call your authorized AT&T dealer.

For Product Information

For information about StarLAN 10 Network components and other AT&T data networking products, call your AT&T Account Executive or the AT&T Advertising Response Center:

- In the United States and Puerto Rico, dial 1-800-247-1212.
- In Canada, dial 1-800-361-7951.
- In all other countries, call your authorized AT&T dealer.

For Design or Installation Service

The AT&T Customer Programming Services Center provides a full range of services including:

- Detailed review of your networking needs
- Network design
- Installation of the StarLAN 10 Network in non-standard and non-AT&T wiring environments

For more information about the AT&T Customer Programming Services Center, contact your AT&T Account Executive or the AT&T Advertising Response Center.

For information on installing a StarLAN 10 Network in standard AT&T wiring environments, call a representative at the original place of purchase. If you purchased the StarLAN 10 Network from AT&T, contact your AT&T Account Executive.

Before You Install a Hub

Before installing a Hub, you should verify the contents of the Hub Unit Kit and determine what, if any, additional hardware is required to install the Hub. You also should contact your network administrator for a copy of the network configuration design and for any additional hardware required for the installation.

Design Considerations

To ensure proper installation of the StarLAN 10 Network, you should have a network configuration design that specifies all of the components to be installed in each room and wiring closet (if applicable). The *StarLAN 10 Network Hub Unit Design Form*, shown on the next page, is used to identify the hardware devices to be connected to a Hub.

If you don't have a network configuration design, it is important for you to realize that there are maximum distance and delay guidelines associated with a StarLAN 10 Network. Your network must conform to these distance and delay guidelines.

If you are installing a StarLAN 10 Network that will use the building's existing twisted-pair wiring, you also should have a basic understanding of the wiring environment in which you intend to install components.

For information about StarLAN 10 Network configurations, read the "Network Configurations" section in this guide or refer to the *StarLAN 10 Network Hardware Design Guide*.

StarLAN 10 Network Hub Unit Design Form

Organization: _____ Date: _____
Hub Location: _____ Hub ID: _____
Network Designer: _____ Building: _____
Hub Serial Number: _____ Hub Purchase Date: _____

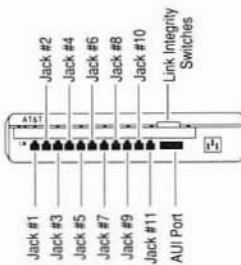

IN or OUT JACK 1:

Node Name or Hub ID: _____
User: _____
Location: _____ Cord Length: _____
Link Integrity Setting: _____

JACK 7:

Node Name or Hub ID: _____
User: _____
Location: _____ Cord Length: _____
Link Integrity Setting: _____

JACK 2:

Node Name or Hub ID: _____
User: _____
Location: _____ Cord Length: _____
Link Integrity Setting: _____

JACK 8:

Node Name or Hub ID: _____
User: _____
Location: _____ Cord Length: _____
Link Integrity Setting: _____

JACK 3:

Node Name or Hub ID: _____

User: _____

Location: _____ Cord Length: _____

Link Integrity Setting: _____

JACK 4:

Node Name or Hub ID: _____

User: _____

Location: _____ Cord Length: _____

Link Integrity Setting: _____

JACK 5:

Node Name or Hub ID: _____

User: _____

Location: _____ Cord Length: _____

Link Integrity Setting: _____

JACK 6:

Node Name or Hub ID: _____

User: _____

Location: _____ Cord Length: _____

Link Integrity Setting: _____

Notes: _____**JACK 9:**

Node Name or Hub ID: _____

User: _____

Location: _____ Cord Length: _____

Link Integrity Setting: _____

JACK 10:

Node Name or Hub ID: _____

User: _____

Location: _____ Cord Length: _____

Link Integrity Setting: _____

JACK 11:

Node Name or Hub ID: _____

User: _____

Location: _____ Cord Length: _____

Link Integrity Setting: _____

AUI PORT:

Node Name or Hub ID: _____

User: _____

Location: _____ Cord Length: _____

What's Supplied in a Hub Unit Kit?

The Hub Unit Kit, illustrated in Figure 3, contains the following components:

- a** A Hub
- b** A bracket for mounting the Hub on the wall
- c** Four wall anchors for mounting the Hub on wallboard
- d** Four No. 8 X 1-inch (2.5 centimeter) panhead sheet-metal screws to hold the bracket on the wall
- e** A UL/CSA listed SJT-type power cable for connecting the Hub's internal power supply to commercial power

If any of the items are missing or damaged, return the kit to the original place of purchase.

FIGURE 3 Hub Unit Kit

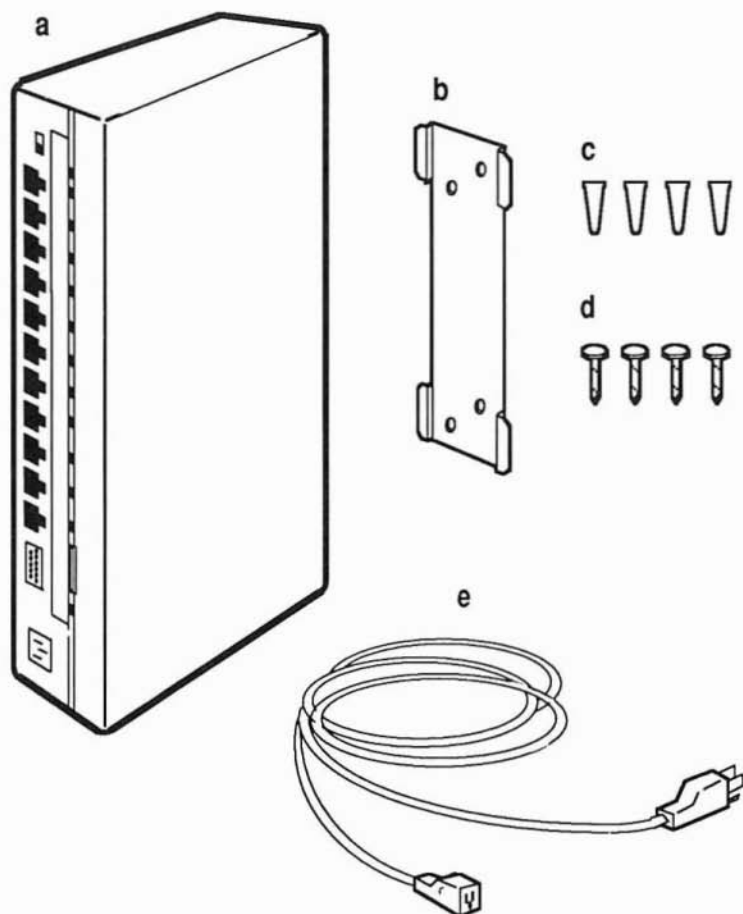

What Else Do You Need?

Based on the network configuration you intend to install, and the type of wiring environment you are working in, you may need one or more of the cords listed in Table 1.

TABLE 1 Modular Cords and Cables for Hub Connections

<u>Type</u>	<u>Lengths</u>	<u>Environments</u>
D8W	2.5 ft. (76 cm)	Hub to Hub, or Hub to wiring closet cross connect
DW8A-DE	10 ft. (3.0 m) 25 ft. (7.6 m) 50 ft. (15.2 m) 75 ft. (22.8 m) 100 ft. (30.5 m) 150 ft. (45.7 m) 200 ft. (60.9 m)	Hub to node, Hub to Hub, or Hub to wiring closet cross connect
DW8A-SE	10 ft. (3.0 m) 25 ft. (7.6 m) 50 ft. (15.2 m)	Hub to 66-type wiring closet cross connect
DP8B-DE (plenum cord)	10 ft. (3.0 m) 25 ft. (7.6 m) 50 ft. (15.2 m) 75 ft. (22.8 m) 100 ft. (30.5 m) 150 ft. (45.7 m) 200 ft. (60.9 m)	Hub to node, Hub to Hub, or Hub to wiring closet cross connect through plenums. (Plenum cord is a fire resistant, low smoke producing cord for use in ceiling/wall locations.)
AUI transceiver cable	33 ft. (10.0 m) 100 ft. (30.0 m) 165 ft. (50.0 m)	Hub to Ethernet transceiver

Your installation also may require one or more of the following:

- 356A Adapter (110-type wiring closet)—used to connect modular cords to a 25-pair cable.
- 451A Adapter (Hub to node)—used to join two modular cords.
- Fiber Adapter (Hub to Hub)— used to connect modular cord to optical fiber.
- Power strip—used to connect more than one Hub to a single electrical receptacle.
- A UL/CSA listed SJT-type extension cord to connect a Hub to an electrical receptacle that is more than 7 feet away from the Hub.
- If you intend to access commercial power via a 220 volt outlet, you must purchase and use a UL/CSA listed 220 volt power cord of the appropriate length, type SJT, 3 conductor, 18 AWG, configured for NEMA6-15.
- Rack mounting bracket—used to mount multiple Hubs, Fiber Adapters, and Fiber Hubs.

If you do not have the appropriate hardware for your installation, have your network administrator call your AT&T Account Executive or the AT&T Advertising Response Center.

Network Configurations

The Hub is compatible with all StarLAN 10 Network components. The Hub supports a variety of industry standard IEEE 802.3 10BASE5, Ethernet, and 10BASE2 Cheapernet DCE devices such as coaxial, broadband, and optical fiber transceivers. The Hub also supports the 10BASE-T standard specifications currently being developed by the IEEE 10BASE-T task force for ANSI/IEEE 802.3 LANs utilizing unshielded twisted-pair wire media at a 10Mbit/sec transmission rate.

All StarLAN 10 Networks, regardless of their size, are installed in a star or multiple-star configuration. In a StarLAN 10 Network with more than one Hub, each Hub is considered a peer (there is no hierarchy relative to the distribution of traffic over the network).

However, when you install a StarLAN 10 Network that uses building wire, that building wire typically is installed in a hierarchical fashion (that is, rooms are wired to satellite wiring closets, which are in turn wired to an equipment room). In such cases, it is important to understand that any resulting hierarchical configuration of the StarLAN 10 Network is due to the physical arrangement of the building wire.

Hub Locations

You can install a Hub in a room or a wiring closet:

- If you are supporting a small network (confined to a room) or if there are more devices in the room than available wall jacks, you should install the Hub in the room.
- If you are supporting a larger network (distributed throughout a floor or a building), you should install the Hubs in wiring closets.

When you install a Hub in a room, you directly connect a device to the Hub using a modular cord or a transceiver (AUI) cable.

When you install a Hub in a wiring closet, you connect a device to the Hub using a combination of media: modular cords, building twisted-pair wires, optical fiber, or transceiver (AUI) cable.

Typical room and wiring closet configurations are discussed in the next section, "Sample Network Configurations."

Sample Network Configurations

This section contains sample StarLAN 10 Network configurations. Each configuration is subject to maximum distance and delay guidelines that must be observed in order for the network to function properly.

The following sections contain information about maximum distance and delay guidelines:

- For information on maximum distances between various devices connected to a Hub, see the “Distance Guidelines for Connections to a Hub” section in this guide.
- For information on the maximum distances and delay guidelines for StarLAN 10 Networks in general, see the *StarLAN 10 Network Hardware Design Guide*.

Single Room Configuration

In a room configuration, StarLAN 10 Network devices are connected directly to one or more Hubs using modular cords, as shown in Figure 4. An Ethernet transceiver can also be connected to a Hub via transceiver (AUI) cable.

Hubs should be located in the room wherever it is convenient for routing modular cords and accessing an electrical outlet.

FIGURE 4 Single Room Configuration

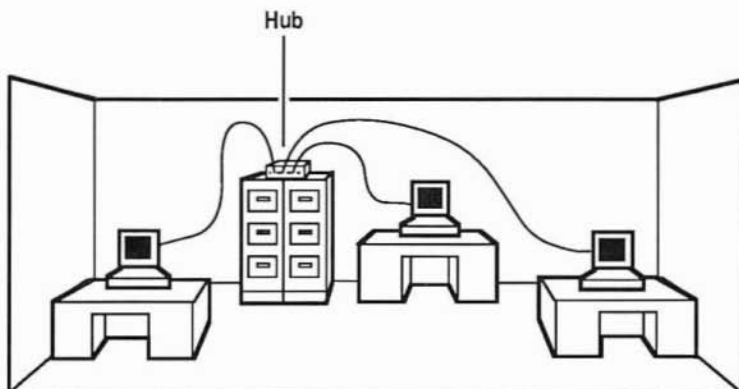

Wiring Closet Supporting Single or Multiple Rooms Configuration

In this configuration, one or more Hubs are mounted in a wiring closet. The Hubs are connected to twisted-pair wires at the cross connects in the wiring closet, which are in turn connected to wall jacks in one or more rooms. StarLAN 10 Network devices then are connected to the wall jacks using modular cords. Figure 5 illustrates this type of configuration.

FIGURE 5 Wiring Closet to Multiple Rooms Configuration

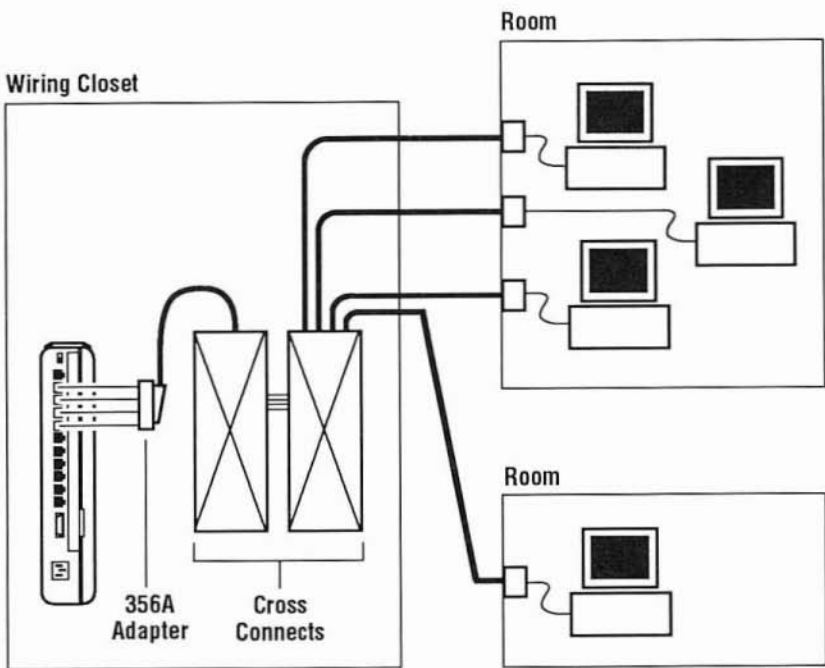

Hub in a Wiring Closet Supporting Hub in a Room Configuration

This configuration is similar to the previous configuration, except the number of StarLAN 10 Network devices to be connected exceeds the number of wall jacks available in the room. In this case, a Hub is installed in the wiring closet and is connected through a wall jack to another Hub installed in the room. The Hub installed in the room provides connections for up to 11 other StarLAN 10 Network devices (including other Hubs). Figure 6 illustrates this type of configuration.

FIGURE 6 Wiring Closet to Hub in a Room Configuration

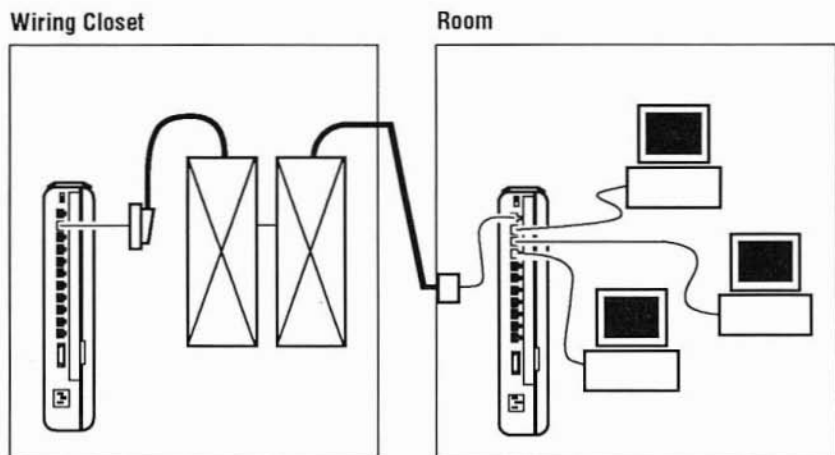

Multiple Wiring Closet Configuration

In this configuration, Hubs installed in wiring closets (that provide service to different areas or floors of the building) are connected together using building wire and/or optical fiber to create a single-building-wide StarLAN 10 Network, as shown in Figure 7.

Optical fiber is an ideal medium for interconnecting Hubs in different wiring closets— offering both increased working distances and network transmissions free of electrical noise generated by other devices in the building. When connecting Hubs via optical fiber, a StarLAN 10 Network Fiber Adapter is required for each Hub-to-optical fiber pair, as shown in Figure 8.

FIGURE 7 Multiple Wiring Closet Configuration

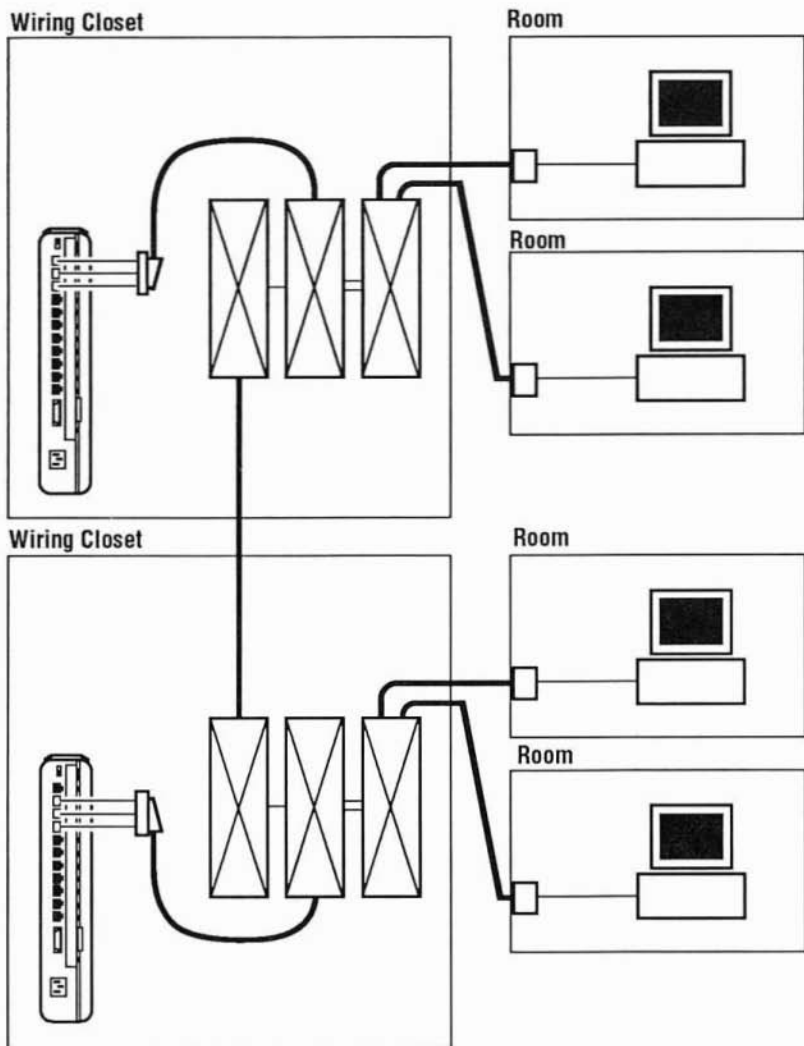
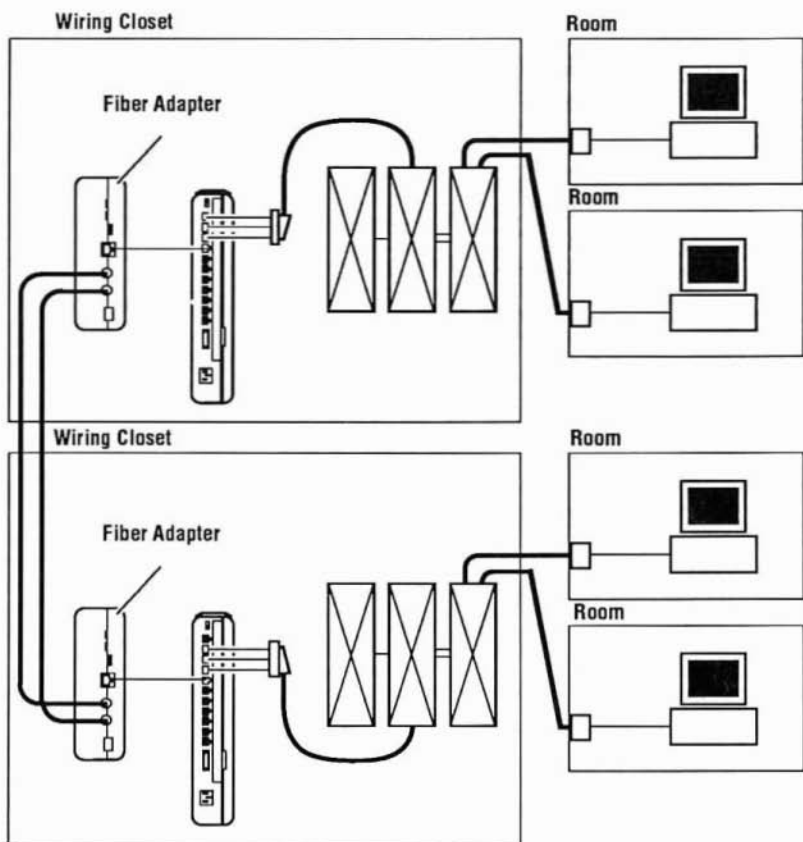

FIGURE 8 Multiple Wiring Closet Configuration Using Optical Fiber



Building-to-Building Configuration

In this configuration, Hubs installed in wiring closets of different buildings are connected together using optical fiber to form a building-to-building StarLAN 10 Network. This configuration requires a StarLAN 10 Network Fiber Adapter for each Hub-to-optical fiber pair connection.

Figure 9 illustrates this type of configuration.

FIGURE 9 Building-to-Building Configuration

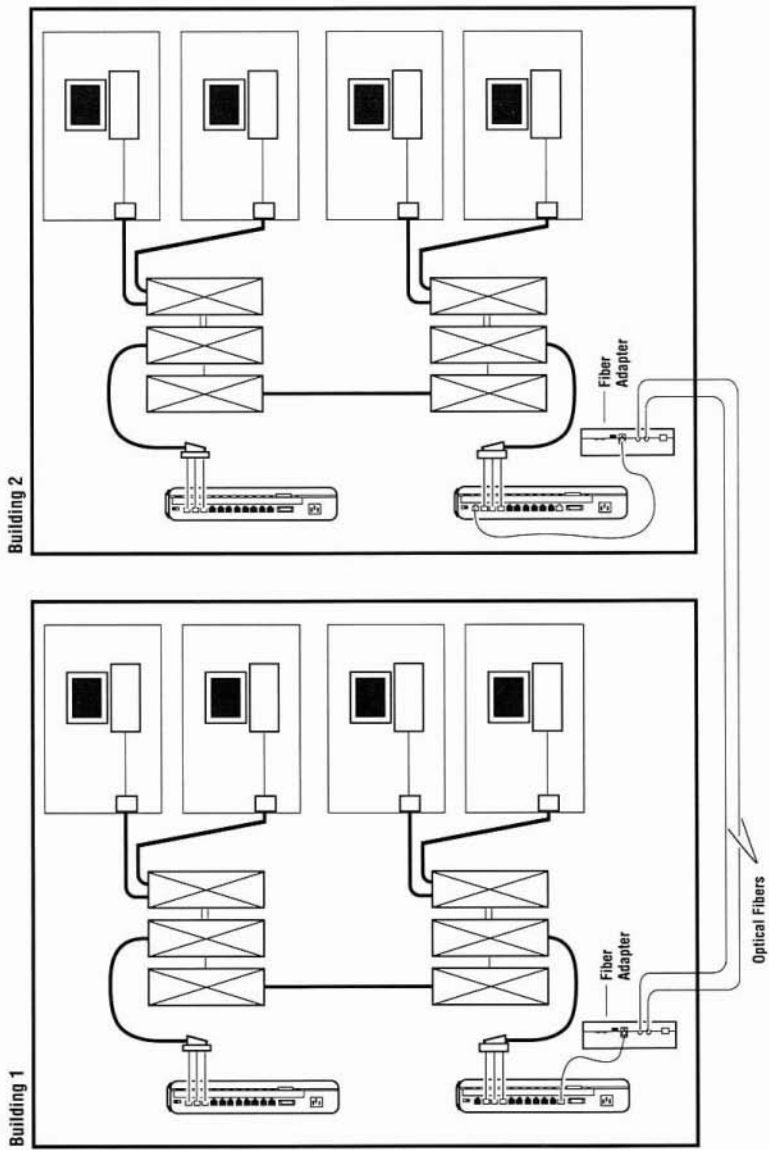

Distance Guidelines for Connections to a Hub

Regardless of the network configuration you choose, whenever you connect a device to a Hub, certain distance guidelines must be observed. These guidelines vary according to the type of device being connected and the connection medium being used.

Table 2 provides maximum distances for connections between a Hub and various other devices.

TABLE 2 Wire and Transceiver Cable Distance Guidelines

<u>Medium</u>	<u>Connection</u>	<u>Distance</u>	
		<u>Feet</u>	<u>Meters</u>
Wire	Hub-to-NAU	328*	100*
Wire	Hub-to-Hub	328*	100*
Wire	Hub-to-AUI Adapter	328*	100*
Wire	Hub-to-Coax Adapter	328*	100*
Wire	Hub-to-Bridge	328*	100*
Wire	Hub-to-Fiber Adapter	49	15
Transceiver (AUI) Cable	Hub-to- Ethernet Transceiver	164	50

* Distance includes Hub-to-Cross Connect Field(s)

Hub Placement

You can set a Hub (horizontally) on a level surface (for example, a table top, a filing cabinet, or a desk top) or mount it (vertically) on a wall.

Before placing a Hub in a room or wiring closet, you must determine if the environmental, electrical, and space requirements for the Hub are satisfied.

Placement Considerations

You can place one or more Hubs in rooms or wiring closets that satisfy the conditions described in the following steps:

- 1 Determine whether the operational environment for the Hub meets the following specifications:

Temperature:	0 to 50 °C 32 to 122 °F
Humidity:	5% to 95% NC
Altitude:	0 to 10,000 feet 0 to 3,017 meters

► **Note**

Where the operational environment differs significantly from the environment in which the Hub was stored, wait at least two hours before installing the Hub. ◀

- 2 Be sure there is a commercial power receptacle within a 7-foot (2.2-meter) cord distance of the Hub. If there is no convenient location within 7 feet (2.2 meters) of a receptacle, use a power strip or grounded extension cord to extend the range of your power cable.

The power requirements for a Hub are:

Voltage: 85 to 250 VAC
Frequency: 47 to 63Hz
Power: 35W

The power receptacle must be a non-switched, 3-pronged, grounded receptacle. There are no voltage switches on the Hub. It operates continuously from 85 to 250 VAC.

► Warnings

- a Do not use a 3-to-2-pronged adapter at the receptacle; use of this type of adapter may result in electrical shock and/or damage to the Hub.
- b The detachable power cable shipped with the Hub Unit Kit is rated only 125 VAC. If you intend to access commercial power via a 220 volt outlet, you must purchase and use a UL/CSA listed 220 volt power cable, type SJT, 3 conductor, 18 AWG, configured for NEMA6-15. ◀

3 Be sure to allocate enough space for

- the Hub. A Hub's dimensions, including the mounting bracket, are:
 - 16.5 inches (42 centimeters) in height
 - 3 inches (8 centimeters) in width
 - 7 inches (18 centimeters) in depth
- the cords that will be connected to the Hub (including the power cable).
- air circulation.
 - When you mount a Hub on the wall, allow 5 inches (12 centimeters) of clearance between the top of a Hub and any other object.
 - When you set a Hub on a level surface, allow 5 inches (12 centimeters) of clearance between the Hub and any object positioned over the Hub. Never place an object directly on top of the Hub.

If you are installing more than one Hub in the same location, it is a good idea to locate Hubs close to one another to simplify administration and troubleshooting tasks, as shown in Figure 10.

If you are mounting multiple StarLAN 10 Network wiring devices within a closet, you may want to consider rack mounting them.

► **Note**

Do not stack Hubs on top of each other. Stacking will affect the heat dissipation capabilities of the Hubs. ◀

The next section describes a procedure for mounting a Hub on a wall in a room or wiring closet. If you are not mounting your Hub on the wall, simply follow Steps 6, 7, and 8 of the following procedure.

FIGURE 10 Collocating Hubs In a Room or Wiring Closet

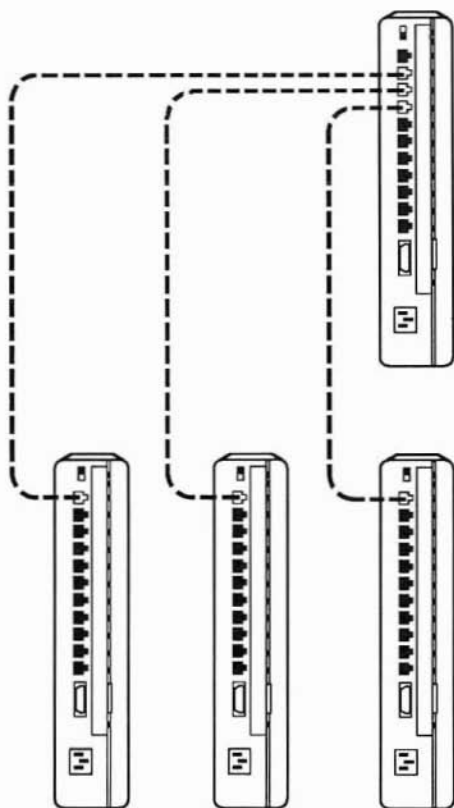

How to Mount a Hub

The following procedure describes how to mount a Hub onto wallboard or wood (a stud, heavy wooden paneling, etc.) using the hardware provided in the Hub Unit Kit. If you are mounting a Hub on a wall other than the types mentioned above (for example, a masonry wall), you may need additional mounting hardware.

To mount a Hub, the only tools you need are a flat-blade screwdriver and a drill with a 3/16-inch bit (when mounting onto wallboard) or a 1/8-inch bit (when mounting onto wood).

If you are not mounting your Hub on a wall (that is, it will sit on a level surface), skip ahead to Step 6 of this procedure.

To mount a Hub, follow these steps:

- 1 Slide the mounting bracket out of the Hub, as shown in Figure 11.

FIGURE 11 Removing the Bracket from the Hub

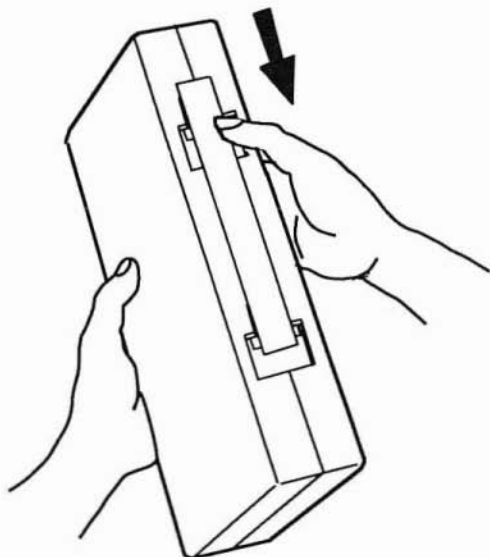

- 2** Position the bracket on the wall, and carefully mark the location for each screw with a pencil. The bracket can be mounted with either end up.
- 3** Mount the bracket, as shown in Figure 12.
 - If you are mounting the bracket onto wallboard between studs:
 - a** Drill four holes for the wall anchors, using a 3/16-inch bit.
 - b** Insert the wall anchors and lightly tap them into place until they are flush with the wall.
 - c** Position the mounting bracket on the wall so that the four holes in the bracket line up with the anchors you have inserted.
 - d** Insert the sheet-metal screws through the holes in the mounting bracket and into the wall anchors.
 - e** Screw the mounting bracket onto the wall.
 - If you are mounting the bracket onto wood:
 - a** Drill four holes for the sheet-metal screws, using a 1/8-inch bit.
 - b** Position the mounting bracket on the wall so that the four holes in the bracket line up with the holes you have drilled.
 - c** Insert the sheet-metal screws through the holes in the mounting bracket and into the drilled holes.
 - d** Screw the mounting bracket onto the wall.

FIGURE 12 Mounting the Bracket

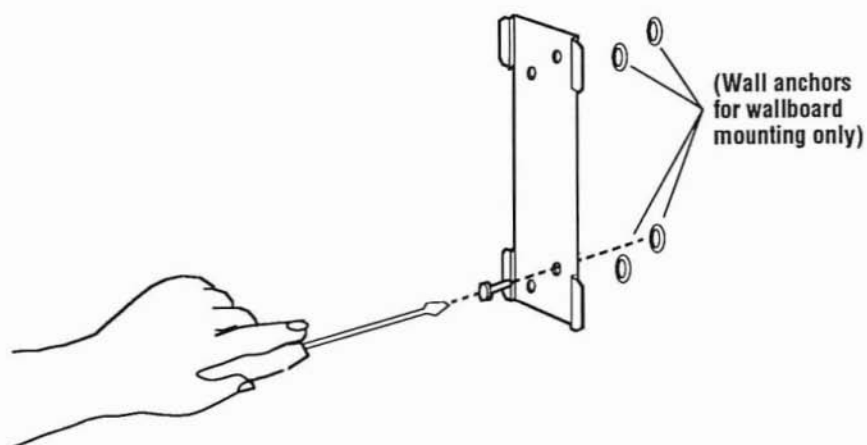

-
- 4** Place the Hub firmly against the wall so that the mounting bracket fits into the slots on the back of the Hub.

- 5 Slide the Hub down on the bracket, as shown in Figure 13, until it locks into place.

FIGURE 13 Placing the Hub on the Bracket

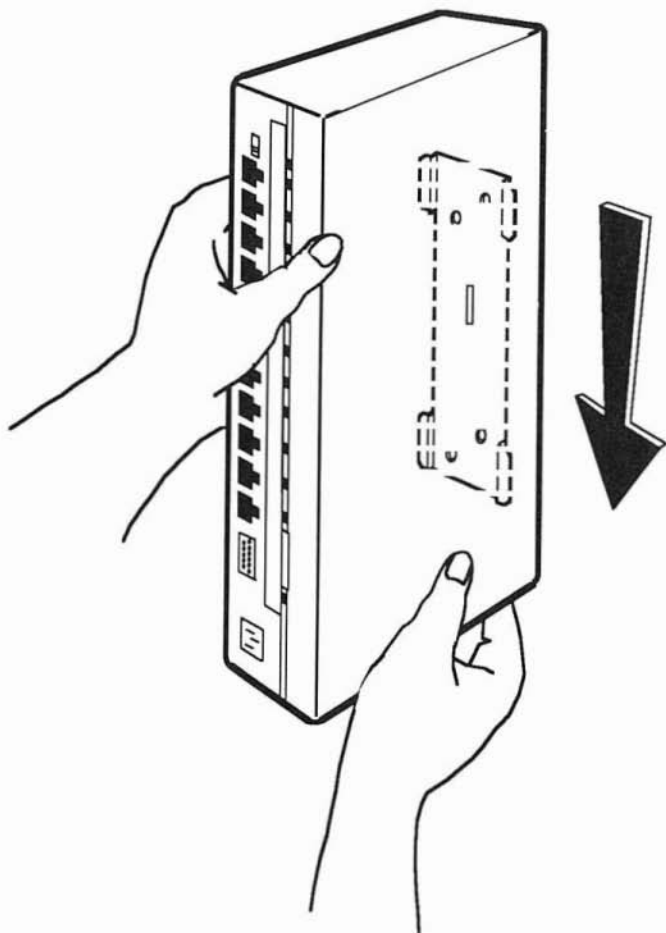

- 6 Connect the power cable to the 3-prong IEC power connector on the front of the Hub, as shown in Figure 14.

FIGURE 14 Connecting the Power Cable

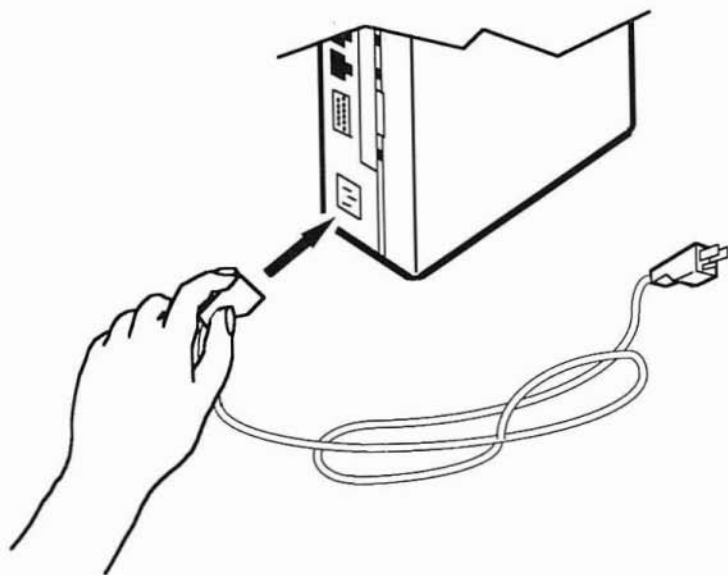

-
- 7 Insert the other end of the power cable into a grounded outlet on the wall, a power strip, or a grounded extension cord.

► **Warning**

Do not use a 3-to-2-pronged adapter at the outlet; use of this type of adapter may result in electrical shock and/or damage to the Hub. ◀

- 8 Repeat Steps 1 through 8 for each Hub to be mounted (Steps 6 through 8 for freestanding Hubs).

Once the Hubs are properly placed in the room or wiring closet, you should perform the power-up LED test in the next section.

Power-Up LED Test

Once the Hub is mounted, you should verify that its LEDs are functioning properly by using the procedure in this section. Figure 15 illustrates all of the LEDs on the Hub.

FIGURE 15 Hub LEDs

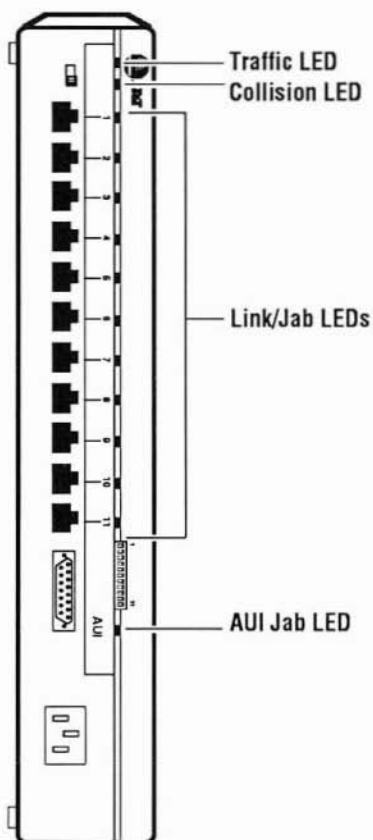

Procedure

To verify that the Hub's LEDs are functioning properly, follow these steps:

- 1 Remove the power cable from the Hub.
- 2 Plug the power cable back into the Hub and observe the LED activity on the Hub:
 - a For approximately two seconds after power is initially applied, the following LED activity should occur.

<u>LED</u>	<u>LED State</u>
Traffic	OFF
Collision	ON
Link/Jab	ON RED
AUI Jab	ON

- b After two seconds, the LEDs should return to their normal states.

<u>LED</u>	<u>LED State</u>
Traffic	ON
Collision	OFF
Link/Jab	OFF (ON AMBER if Link Integrity is disabled)
AUI Jab	OFF

► Note

If you are running this test with any of the twisted-pair wire jacks connected, the status of the Link/Jab LED may vary. Therefore, it is recommended that you disconnect all jacks before performing the power-up LED test. ◀

If all LEDs followed the described sequence, then the Hub's LEDs are operating properly. If there is a deviation from the described sequence, proceed as follows depending on the deviation:

- If all LEDs remained OFF, determine whether the power source is functioning by plugging another device into the receptacle. Then do *one* of the following:
 - If the receptacle is not providing power, plug the Hub into another receptacle known to have power.
 - If the receptacle is providing power and all of the Hub's LEDs remain OFF, check the connection between the Hub and the power receptacle by following these steps:
 - a Unplug the Hub from the receptacle.
 - b Disconnect the female connector on the power cable from the IEC Power Connector on the front of the Hub.
 - c Re-insert the female connector into the IEC Power Connector.
 - d Plug the Hub into the receptacle.

If all of the LEDs remain OFF, either the Hub or the power cable is not operating properly. Contact a representative at the original place of purchase or a Service Technician.

- If there are any other deviations from the power-up sequence in Step 2b, return the Hub to the original place of purchase. If you purchased your Hub from AT&T:
 - In the United States and Puerto Rico, call the toll-free AT&T National System Support Center hotline at 1-800-922-0354.
 - In Canada, call the toll-free AT&T Canada, Inc. hotline at 1-800-387-0913.
 - In all other countries, call your authorized AT&T dealer.

Now that you've completed the power-up test successfully, proceed to the next section, "How to Label Hubs."

How to Label Hubs

You should label all Hubs in a StarLAN 10 Network to simplify the tasks of administration and troubleshooting.

The Hub to which all other Hubs in a room or wiring closet are connected is called a *primary Hub*. All Hubs connected to a primary Hub within the same room or wiring closet are called *secondary Hubs*.

► **Note**

The *StarLAN 10 Network Hub Unit Design Form*, included in the “Before You Install a Hub” section of this guide, should be maintained to identify the destination of each connection to the Hub. ◀

To label one or more Hubs in a room or a wiring closet, follow these steps:

- 1 Label the primary Hub (to which all other Hubs in the room or wiring closet will be connected) as “Hub 1.”
- 2 Label all secondary Hubs in the room or wiring closet as “Hub 2” with extensions in sequential order. For example, the first secondary Hub should be labeled “Hub 2-1” the second secondary Hub should be labeled “Hub 2-2,” etc., as shown in Figure 16.

FIGURE 16 Labeling Hubs

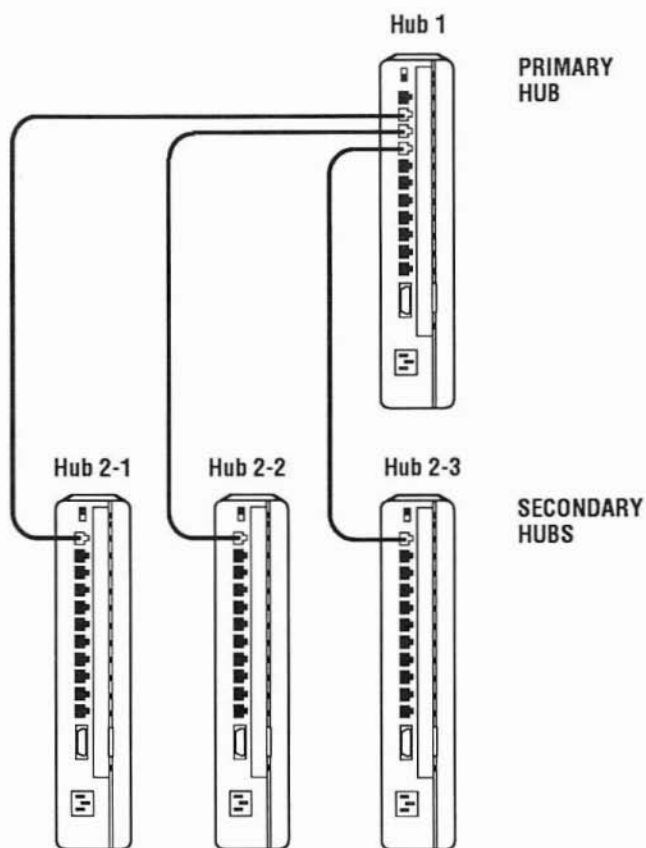

Making Connections to a Hub

Each Hub has 11 modular (RJ45) jacks and one AUI port. The jacks labeled “2” through “11” are permanently configured as IN jacks, and the jack labeled “1” is a switchable IN/OUT jack.

This section describes how to make connections to a Hub in a room or a wiring closet to form a StarLAN 10 Network. Before making any connections to a Hub or any other StarLAN 10 Network device, you should read the “General Connection Rules” section that follows.

Once you have completed making connections to the Hub, test the network traffic movement through the Hub by following the procedure in “Verifying Connections to the Hub” later in this guide.

General Connection Rules

The following connection rules apply to all StarLAN 10 Network configurations:

- When you connect a transceiver (AUI) cable to a Hub’s AUI port, you must connect the DCE D-type male connector of the transceiver cable to the DTE D-type female connector on the Hub.
- When connecting two devices together using twisted-pair wire, you must connect the OUT jack of one device to the IN jack of the other device.

Certain StarLAN 10 Network hardware devices (such as the Hub, the Coax Adapter, the Fiber Hub, and the Fiber Adapter) have switchable IN/OUT jacks. When connecting a modular cord to an IN/OUT jack, you must check the position of the IN/OUT switch to verify that the IN to OUT connection rule is obeyed.

To set the IN/OUT switch on a mounted Hub to the OUT position, push the switch up, as shown in Figure 15.

FIGURE 17 Setting the IN/OUT Switch on a Hub

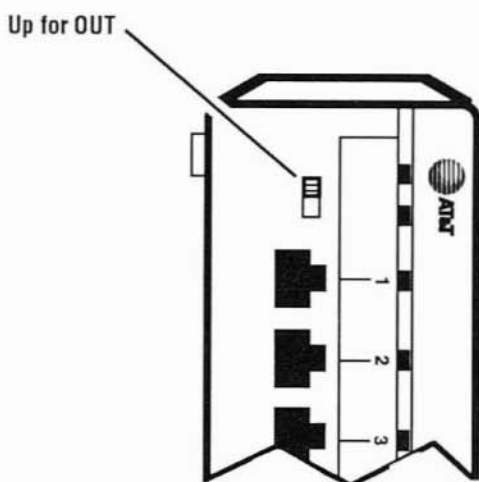

-
- The Link Integrity option switches are set to enable by default, as shown in Figure 18. When connecting using twisted-pair wire, you must make sure that the Hub's Link Integrity function is set appropriately.

Certain devices do not support Link Integrity. If you connect the Hub to a device that does not support Link Integrity, you must make sure that the Link Integrity function is disabled for that jack on the Hub. If you connect the Hub to a device that supports Link Integrity, and the device has the Link Integrity function enabled, you must make sure that the function is enabled for that jack on the Hub.

FIGURE 18 Link Integrity Option Switch

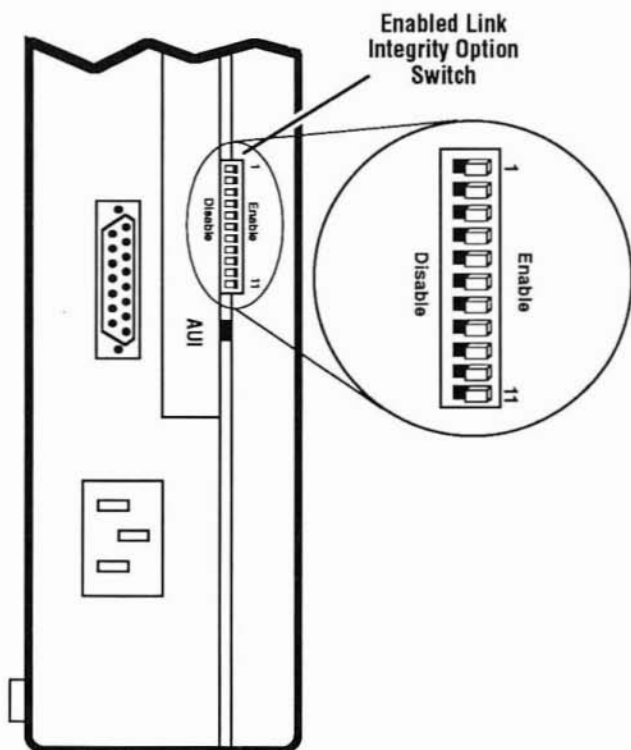

If the Link/Jab LED is ON GREEN, the receive portion of the link between the Hub and the connected device is good. If it is OFF, there is a problem with the connection.

- When you are connecting more than two Hubs in the same room, select a Hub to serve as the primary Hub for this room (the Hub to which all other Hubs in the room will be connected), as shown in Figure 19. This will minimize the number of Hubs in any one path (end-to-end connection) on the network.

FIGURE 19 Connecting More Than Two Hubs In a Room

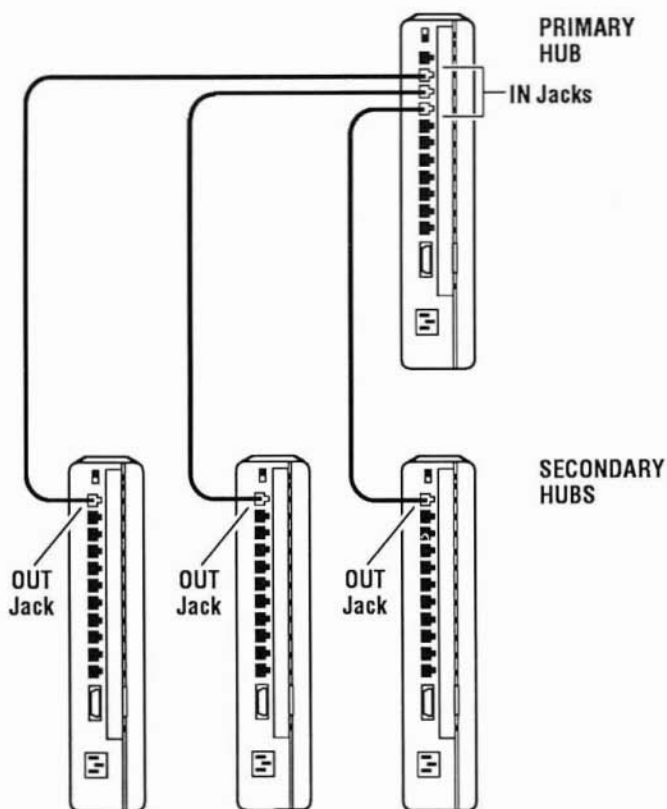

Connections to a Hub in a Room

A Hub installed in a room can support connections to the following:

- StarLAN 10 Network nodes located in the room (using modular cords)
- an Ethernet transceiver in the room (using transceiver cable)
- other Hubs in that room (using modular cords)
- a Hub in a wiring closet (using modular cords)

The procedures in this section describe connections between a Hub in a room and a StarLAN 10 Network node, an Ethernet transceiver, and another Hub located in the same room.

For information on connecting a Hub in a room to a Hub in a wiring closet, see “Hub-to-Hub Connection (Wiring Closet to Room)” later in this section.

Node-to-Hub Connection (Room)

To connect a StarLAN 10 Network node to a Hub in a room, follow these steps:

- 1 Select the appropriate length DW8A-DE modular cord for the connection.
- 2 Connect one end of the modular cord to the OUT jack on the hardware device (for example, a PC NAU) you are connecting to the Hub as shown in Figure 20.
- 3 Route the free end of the modular cord to the area where the Hub is located.
- 4 Connect the free end of the modular cord to an IN jack on the Hub.

► **Note**

If possible, reserve the switchable IN/OUT jack on the Hub for a connection to another Hub. ◀

- 5 Make sure that the Link Integrity setting for the modular jack on the Hub agrees with that of the node.

FIGURE 20 Node-to-Hub Connection (Room)

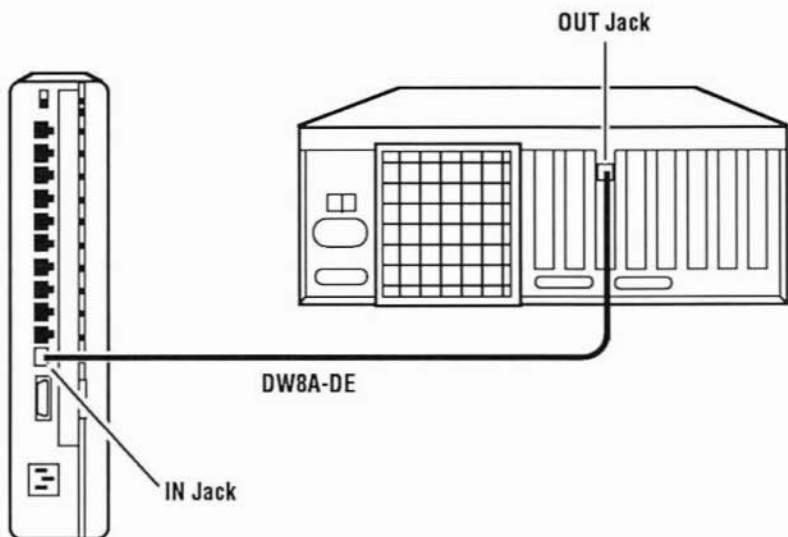

Ethernet Transceiver-to-Hub Connection (Room)

To connect an Ethernet transceiver to a Hub in a room, follow these steps:

- 1 Select the appropriate length transceiver (AUI) cable for the connection.
- 2 Be sure the SQE (Signal Quality Error) test function on the transceiver is *disabled*. For information on how to disable the SQE test function, see the transceiver documentation.

► **Note**

If you enable the SQE test function, a high number of collisions will occur. ◀

- 3 Connect the female end of the transceiver cable to the port on the Ethernet transceiver as shown in Figure 21.
- 4 Route the free end of the transceiver cable to the area where the Hub is located.
- 5 Connect the male end of the transceiver cable to the AUI port on the Hub.

FIGURE 21 Ethernet Transceiver-to-Hub Connection (Room)

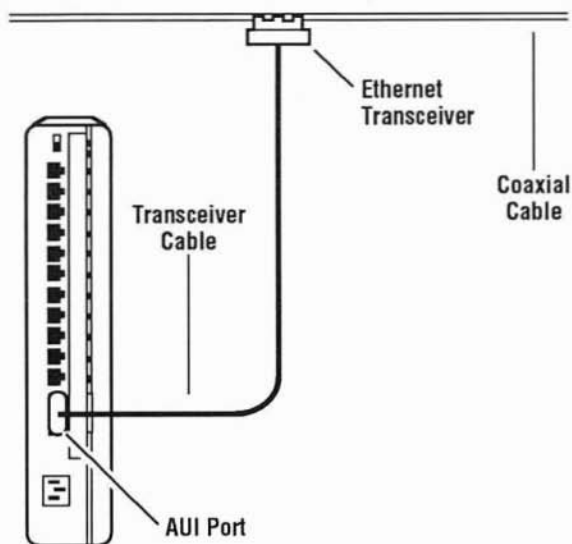

Hub-to-Hub Connection (Room)

To connect one Hub (Hub A) to a second Hub (Hub B) in the same room, follow these steps:

- 1 Set the IN/OUT switch on Hub B to the OUT position as shown in Figure 17.
- 2 Make sure that the Link Integrity settings for the modular jacks on both Hubs agree.
- 3 Select the appropriate length of modular cord (DW8A-DE or D8W) for the Hub-to-Hub connection.
- 4 Connect one end of the modular cord to the IN/OUT jack of Hub B as shown in Figure 22.
- 5 Route the free end of the modular cord to the area where Hub A is located.
- 6 Connect the free end of the modular cord to an IN jack on Hub A.

► Note

Remember, when connecting two or more Hubs in the same room, it is important to minimize the number of Hubs in any one path (end-to-end connection) on the network. For information on how you might minimize the number of Hubs in a path, read the “General Connection Rules” section earlier in this guide. ◀

FIGURE 22 Hub-to-Hub Connection (Room)

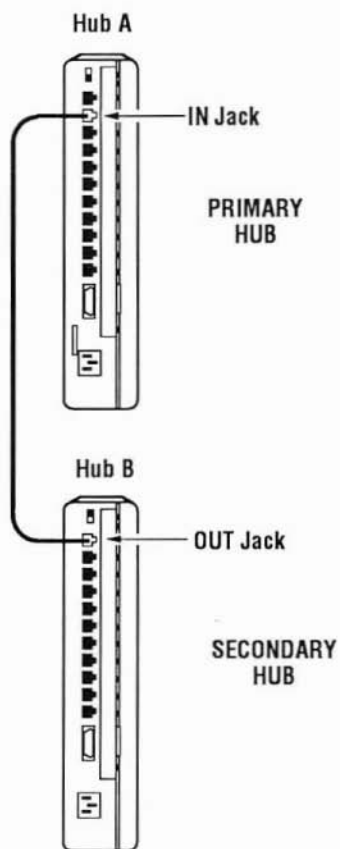

Connections to a Hub in a Wiring Closet

A Hub installed in a wiring closet can support connections to the following:

- wall jacks in rooms (using building twisted-pair wire)
- a Hub located in a room (using building twisted-pair wire)
- an Ethernet transceiver (using transceiver cable)
- Hubs installed in the same wiring closet (using modular cords)
- a Hub located in another wiring closet (using building twisted-pair wire or optical fiber)
- a Hub located in a wiring closet in another building (using optical fiber)

This section contains the procedures for connecting a Hub in a wiring closet to a room wall jack and to a Hub in a room.

The procedures for connecting devices (an Ethernet transceiver or multiple Hubs) to a Hub within that wiring closet are the same as for connecting them in a room. The following sections contain information on connecting devices:

- For information on connecting an Ethernet transceiver to a Hub in a wiring closet, read the "Ethernet Transceiver-to-Hub Connection (Room)" section earlier in this guide.
- For information on connecting a Hub to another Hub in the same wiring closet, read the "Hub-to-Hub Connection (Room)" section earlier in this guide.

Instructions for making Hub-to-Hub connections between wiring closets will be provided later in this guide.

► Note

If you are not familiar with wiring closet connections or do not feel comfortable attempting such connections, it is recommended that you retain the services of an AT&T technician or other similarly qualified professional. For installation service information, read the "To Contact AT&T" section in the beginning of this guide. ◀

Before making any of these wiring closet connections, you must know what type of wiring closet hardware and associated wiring is being used in the building. To determine what type of wiring is in the building, read the next section, "Identifying the Building's Wiring Environment."

After you have determined the type of wiring environment the building has, turn to the appropriate procedure to connect each Hub you are installing.

Identifying the Building's Wiring Environment

Each StarLAN 10 Network hardware device you connect using the building twisted-pair wire requires two pairs of wires: one pair to transmit network signals and one pair to receive network signals. In a 4-pair cable or a 25-pair cable with 4-pair groups, pairs 2 and 3 are used.

Your wiring closet will contain one of the two possible types of cross connects: 110-type cross connects or 66-type cross connects (shown in Figure 23).

FIGURE 23 Identifying Cross Connects

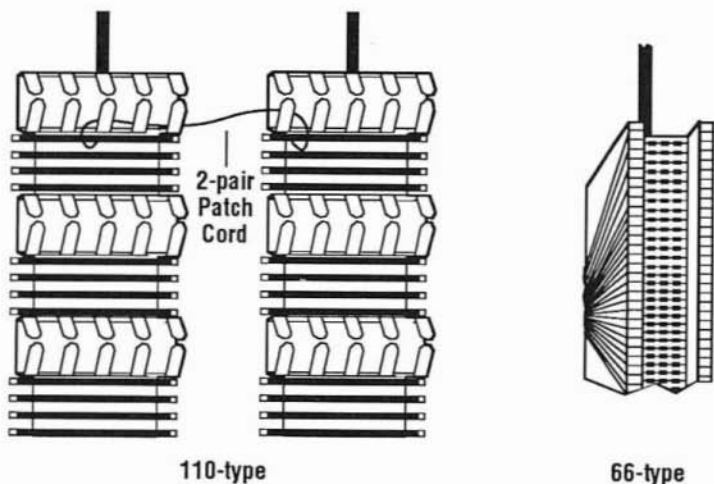

If your wiring closet is equipped with 110-type cross connects, it is called a "Premises Distribution System" (PDS).

If your wiring closet is equipped with 66-type cross connects, it is either a tip/ring wiring environment or a 1A-Key wiring environment, depending on the type of telephone equipment in your building.

If your building is a tip/ring wiring environment, you can identify the unused pairs (the twisted-pair used to complete the connection between the Hub and a wall jack or another cross connect) on the 66-type cross connect by the color codes in Table 3.

**TABLE 3 Color and Function of Pairs in a 25-Pair Cable
(Tip/Ring Environment)**

<u>DW8A-SE Cord</u>		<u>25-Pair Station Cable</u>	
<u>Color</u>	<u>Group</u>	<u>Color</u>	<u>Function*</u>
	1	W-BL	Tip
		BL-W	Ring
W-O		W-O	OD1
O-W		O-W	OD2
W-G		W-G	ID1
G-W		G-W	ID2
		W-BR	Power
		BR-W	Power
	2	W-S	Tip
		S-W	Ring
W-O		R-BL	OD1
O-W		BL-R	OD2
W-G		R-O	ID1
G-W		O-R	ID2
		R-G	Power
		G-R	Power
	3	R-BR	Tip
		BR-R	Ring
W-O		R-S	OD1
O-W		S-R	OD2
W-G		BK-BL	ID1
G-W		BL-BK	ID2
		BK-O	Power
		O-BK	Power

* OD stands for Out Data. OD1 and OD2 are the transmit pair. ID stands for In Data. ID1 and ID2 are the receive pair.

TABLE 3 Color and Function of Pairs In a 25-Pair Cable (Tip/Ring Environment) (continued)

<u>DW8A-SE Cord</u>		<u>25-Pair Station Cable</u>	
<u>Color</u>	<u>Group</u>	<u>Color</u>	<u>Function*</u>
	4	BK-G	Tip
		G-BK	Ring
W-O		BK-BR	OD1
O-W		BR-BK	OD2
W-G		BK-S	ID1
G-W		S-BK	ID2
		Y-BL	Power
		BL-Y	Power
	5	Y-O	Tip
		O-Y	Ring
W-O		Y-G	OD1
O-W		G-Y	OD2
W-G		Y-BR	ID1
G-W		BR-Y	ID2
		Y-S	Power
		S-Y	Power
	6	V-BL	Tip
		BL-V	Ring
W-O		V-O	OD1
O-W		O-V	OD2
W-G		V-G	ID1
G-W		G-V	ID2
		V-BR	Power
		BR-V	Power
		V-S	Spare
		S-V	Spare

* OD stands for Out Data. OD1 and OD2 are the transmit pair. ID stands for In Data. ID1 and ID2 are the receive pair.

If your building is a 1A-Key wiring environment, you can identify the unused pairs (the twisted-pair used to complete the connection between the Hub and a wall jack or another cross connect) on the 66-type cross connect by the color codes in Table 4.

► **Note**

Pairs 23, 24, and 25 are used in conjunction with a 149B Adapter; all other types of connections (that is, PC/1A-Key Adapter and Armiger Adapter) use pairs 16, 17, 21 and 22. ◀

TABLE 4 Color and Function of Pairs in a 25-Pair Cable (1A-Key Environment)

<u>DW8A-SE Cord</u>		<u>25-Pair Station Cable</u>	
<u>Color</u>	<u>Pair</u>	<u>Color</u>	<u>Function*</u>
W-O	23, 24	V-G	OD1
O-W		G-V	OD2
W-G	24, 25	V-BR	ID1
G-W		BR-V	ID2
W-O		V-BR	OD1
O-W		BR-V	OD2
W-G	23, 25	V-S	ID1
G-W		S-V	ID2
W-O		V-G	OD1
O-W		G-V	OD2
W-G	16, 17	V-S	ID1
G-W		S-V	ID2
W-O		Y-BL	OD1
O-W		BL-Y	OD2
W-G	21, 22	Y-O	ID1
G-W		O-Y	ID2
W-O		V-BL	OD1
O-W		BL-V	OD2
W-G		V-O	ID1
G-W		O-V	ID2

* OD stands for Out Data. OD1 and OD2 are the transmit pair. ID stands for In Data. ID1 and ID2 are the receive pair.

Hub-to-Wall Jack Connection (Wiring Closet)

You can connect a Hub in a 66-type or 110-type wiring closet to room wall jacks.

To connect a modular wall jack in a room to a Hub in a wiring closet, you must connect the appropriate cross connects in the closet to one of the Hub's IN jacks:

- If this closet contains 110-type wiring, use a DW8A-DE modular cord to connect the IN jack of the Hub to a 356A Adapter that, in turn, is connected to the appropriate pairs of wires on the wiring block in the purple field.

Then connect the same wire pairs on the purple field to the wire pairs on the blue field that lead to the room's wall jack with either a 2-pair or 3-pair patch cord (see Figure 24).

FIGURE 24 Hub to 110-type Cross Connect

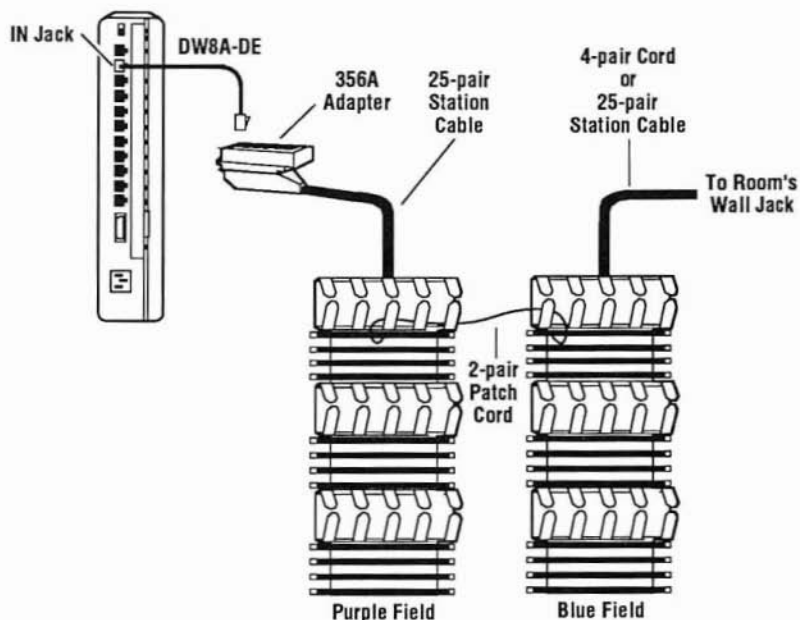

- If this closet contains 66-type wiring, use a DW8A-SE modular cord to connect the IN jack of the Hub to the appropriate wire pairs on the cross connect leading to the room's wall jack (see Figure 25).

To connect the DW8A-SE modular cord to the wire pairs on the cross connect, you punch down the appropriate leads of the DW8A-SE cord to the selected pairs on the cross-connect block. To determine which unused pairs are appropriate for use in your wiring environment, see Table 3 or Table 4.

FIGURE 25 Hub to 66-type Cross Connect

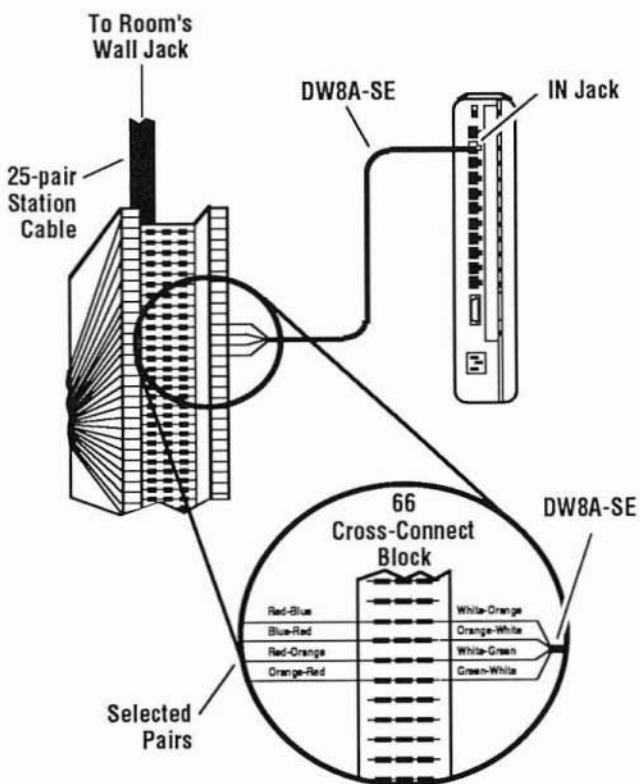

Hub-to-Hub Connection (Wiring Closet to Room)

To connect a Hub in a wiring closet to a Hub in a room, you must first connect the Hub in the wiring closet to a wall jack in the room as described in the previous section.

After you have made that connection, connect the Hub in the room to the wall jack using modular cord, as described in the following steps:

- 1 Set the IN/OUT switch on the Hub in the room to the OUT position, as shown in Figure 17.
- 2 Make sure that the Link Integrity settings for the modular jacks on both Hubs agree.
- 3 Select the appropriate length DW8A-DE modular cord to connect the Hub to the wall jack.
- 4 Connect one end of the modular cord to the IN/OUT jack of the Hub.
- 5 Route the free end of the modular cord to the wall jack.
- 6 Connect the free end of the modular cord to the wall jack.

Hub-to-Hub Connection Between Wiring Closets

The two procedures in this section describe how to connect Hubs in wiring closets using twisted-pair wire and optical fiber, respectively.

Each procedure assumes that a twisted-pair wire or optical fiber path already exists between the two target wiring closets. You can take advantage of this existing path to connect a Hub in one closet to a Hub in a second closet.

Closet-to-Closet Hub Connection Using Twisted-Pair Wire

To connect a Hub in wiring closet A to a Hub in wiring closet B using existing twisted-pair wire, follow these steps:

- 1 Connect one of the Hub's IN jacks in wiring closet A to the appropriate cross connects for your wiring environment.
 - If this closet contains 110-type wiring, use a DW8A-DE modular cord to connect the IN jack of the Hub to a 356A Adapter that, in turn, is connected to the appropriate pairs of wires on the wiring block in the purple field.

Then connect the same wire pairs on the purple field to the wire pairs on the gray/white field leading to wiring closet B with either a 2-pair or 3-pair patch cord (see Figure 26).

FIGURE 26 Hub to 110-type Cross Connect

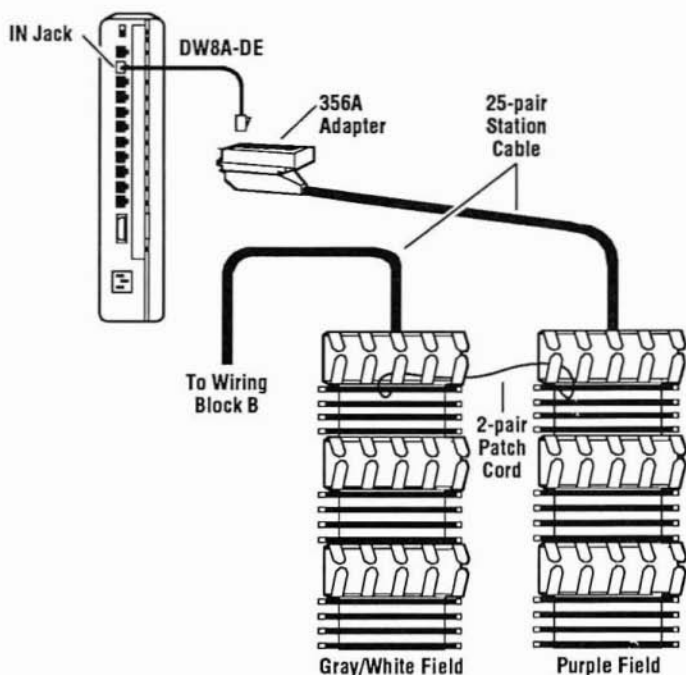

- If this closet contains 66-type wiring, use a DW8A-SE modular cord to connect the IN jack of the Hub to the appropriate wire pairs on the cross connect that are connected to wiring closet B (see Figure 27).

To connect the DW8A-SE modular cord to the wire pairs on the cross connect, you punch down the appropriate leads of the DW8A-SE cord to the selected pairs on the cross-connect block. To determine which unused pairs are appropriate for use in your wiring environment, see Table 3 or Table 4.

FIGURE 27 Hub to 66-type Cross Connect

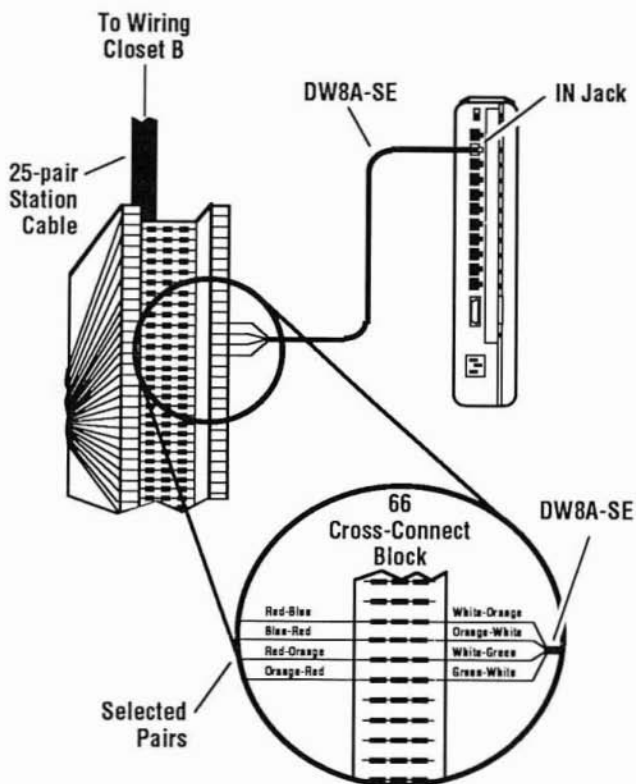

- 2 Set the IN/OUT switch on the Hub in wiring closet B to the OUT position, as shown in Figure 17.
- 3 Make sure that the Link Integrity settings for the modular jacks on both Hubs agree.
- 4 Connect the IN/OUT jack of the Hub in wiring closet B to the wire pairs on the cross connect that lead to the Hub in wiring closet A, as shown in Figure 28 (for a 110-type wiring closet) or Figure 29 (for a 66-type wiring closet).

FIGURE 28 110-type Cross Connect to Hub

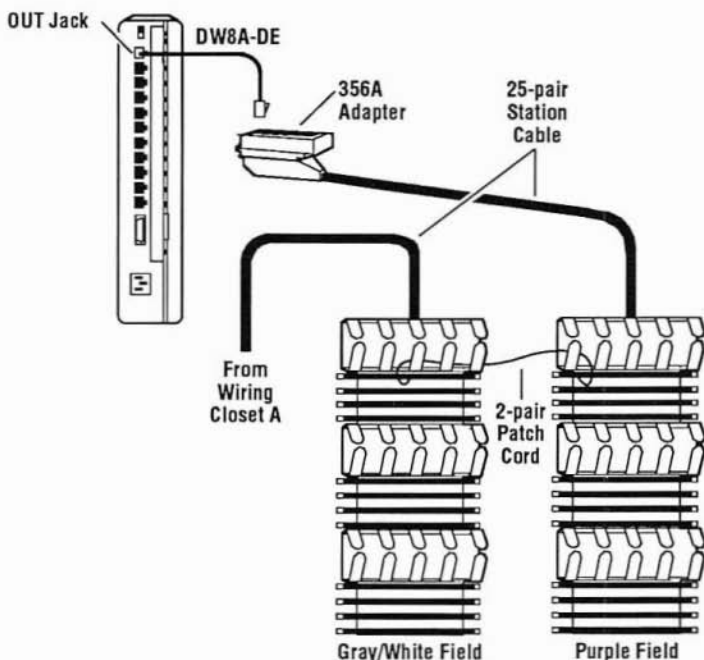
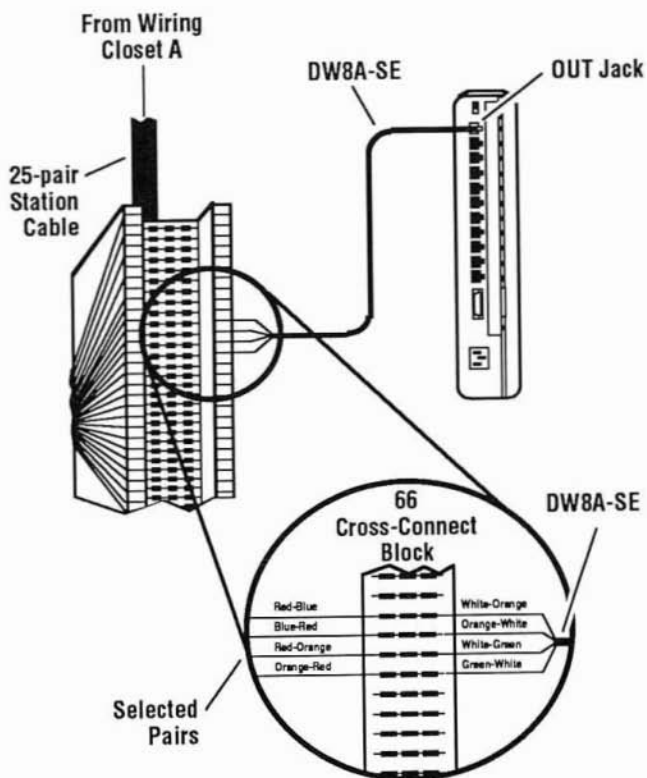

FIGURE 29 66-type Cross Connect to Hub



Closest-to-Closet Hub Connection Using Optical Fiber

To connect a Hub in one wiring closet to a Hub in another wiring closet using optical fiber, you must use two StarLAN 10 Network Fiber Adapters. The Fiber Adapter accepts a modular cord from the Hub and two optical fiber connections (transmit and receive). Both ends of the optical fiber have this same type of connection.

For additional information about the Fiber Adapter, see the *StarLAN 10 Network Fiber Adapter Installation Guide*.

To connect a Hub in wiring closet A to a Hub in wiring closet B using optical fiber, follow these steps:

- 1 Set the IN/OUT switch on the Fiber Adapter in wiring closet A to the OUT position.
- 2 Make sure that the Link Integrity setting of the Hub in wiring closet A matches that of the Fiber Adapter.

- 3 Connect an IN jack of the Hub in wiring closet A to the IN/OUT jack on the Fiber Adapter using a modular cord with a maximum length of 15 meters, as shown in Figure 30.

FIGURE 30 Connecting a Hub to a Fiber Adapter (Closet A)

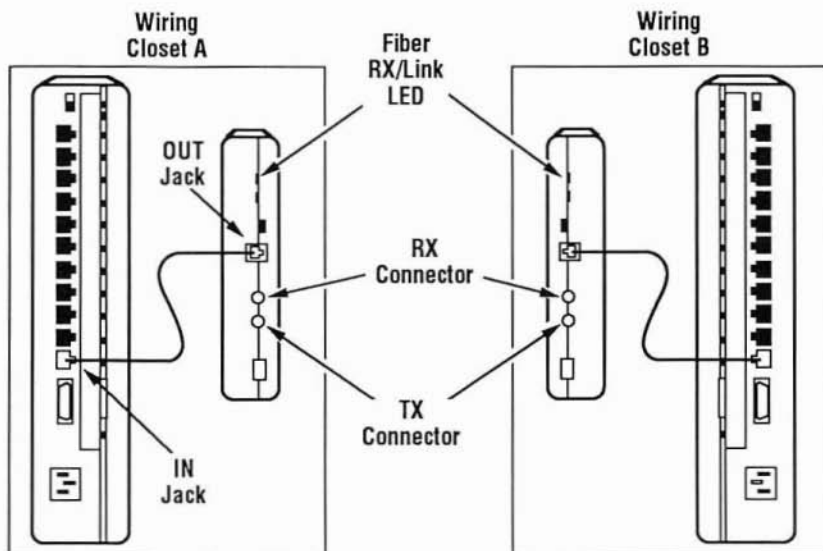

- 4 Select two optical fibers that run from wiring closet A to wiring closet B.
- 5 Connect one optical fiber in wiring closet A to the Rx (receive) connector on the Fiber Adapter in wiring closet A. Then connect the other optical fiber in wiring closet A to the Tx (transmit) connector on the Fiber Adapter in wiring closet A. (See Figure 31.)
- 6 Go to wiring closet B.

- 7 Connect the optical fiber from the Tx (transmit) connector in wiring closet A to the Rx (receive) connector on the Fiber Adapter in wiring closet B. The Fiber Rx/Link LED (green) on the Fiber Adapter will turn ON when the correct optical fiber is connected.

If the Fiber Rx/Link LED on the Fiber Adapter does not light, disconnect that fiber and connect the other optical fiber to the Rx (receive) connector.

If the Fiber Rx/Link LED on the Fiber Adapter still does not light, refer to the *StarLAN 10 Network Fiber Adapter Installation Guide* for troubleshooting procedures.

- 8 If the Fiber Rx/Link LED lights, connect the remaining fiber to the Tx (transmit) connector on the Fiber Adapter.
- 9 Set the IN/OUT switch on the Fiber Adapter in wiring closet B to the IN position.
- 10 Set the IN/OUT switch on the Hub in wiring closet B to the OUT position, as shown in Figure 17.
- 11 Make sure that the Link Integrity setting of the Hub in wiring closet B matches that of the Fiber Adapter.

- 12 Connect the IN/OUT jack of the Hub in wiring closet B to the IN/OUT jack on the Fiber Adapter in wiring closet B using a modular cord.
- 13 If desired, enable the Link Integrity Pass Thru switch on both Fiber Adapters in rooms A and B. The Pass Thru function sends link failure indications received at a Fiber Adapter through to a Hub. Thus, the Link/Jab LED on the Hub in closet B can indicate link failures on the modular cord connection in closet B, the optical fiber connection between closets, or the modular cord connection in closet A. The Pass Thru function is only supported on Fiber Adapters that have Wire Link Integrity enabled. For more information, see the *Fiber Adapter Installation Guide*.

When you have properly connected the Hubs and Fiber Adapters, the Hub-to-Hub connection using modular cord and optical fiber will look like Figure 31.

FIGURE 31 Closet-to-Closet Connection Using Optical Fiber

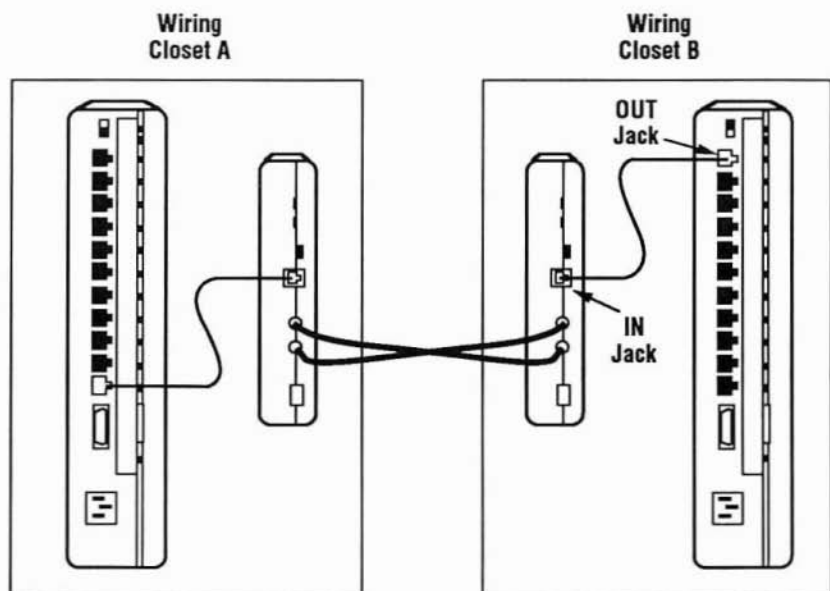

Hub-to-Hub Connection Between Buildings

The StarLAN 10 Network allows you to share information between buildings. To do this, you connect a Hub in a wiring closet (typically the closet in the basement, called the “equipment room”) in one building to a Hub located in a wiring closet of another building using Fiber Adapters and optical fiber as the medium.

The optical fibers used to connect Fiber Adapters can be up to 6560 feet (2 kilometers) long. The use of optical fiber as a connection medium between Hubs allows you to create a single StarLAN 10 Network that services users in multiple buildings. When designing a multiple-building StarLAN 10 Network, you must adhere to delay and distance guidelines.

Each connection to optical fiber requires a StarLAN 10 Network Fiber Adapter. The Fiber Adapter accepts a modular cord from the Hub and two optical fiber connections (transmit and receive) from the optical fiber cross connect. Both closets must have this type of connection.

For additional information on the Fiber Adapter, see the *StarLAN 10 Network Fiber Adapter Installation Guide*.

To connect a Hub in building A to a Hub in building B, follow the procedure “Closet-to-Closet Hub Connection Using Optical Fiber” earlier in this guide.

Verifying Connections to the Hub

After you have completed making proper connections to the Hub's AUI port and the modular jacks, you should verify that these connections are good by performing the procedure in this section:

► Note

Before performing this procedure, make the proper connections to the Hub's AUI port and its modular jacks. Verify that the connected devices are powered on and that Link Integrity is configured properly on the Hub and the connected twisted-pair devices. ◀

Procedure

To verify connections to the Hub, follow these steps:

- 1 Plug in the Hub and turn on the devices connected to it.
- 2 Load the network software on all of the computers connected to the Hub.
- 3 After the network software has been loaded, verify connectivity through the Hub by attempting to establish communications between any two computers connected to it:
 - If you are using AT&T StarGROUP™ software, you can run the NETSTAT Program to test connectivity. For information on running the NETSTAT Program, see the guides packaged with the StarGROUP software.
 - If you are not using AT&T StarGROUP software, see the documentation supplied with your software for a method of checking network connectivity.

- 4 If the connectivity test performed in Step 3 is not successful, verify the relationship between the Hub's AUI port/modular jacks and the connected devices. Verify that the OUT to IN connection rule is obeyed (for more information, see the section entitled "General Connection Rules" earlier in this guide).

If the relationship is correct, the Hub is probably not the source of the problem. Contact your system administrator for further assistance.

Interpreting Hub LEDs

Your Hub has LEDs which verify connections to twisted-pair wire devices (link/jab LEDs) and indicate the presence of the following:

- network traffic (traffic LED),
- network collisions (collision LED),
- collision storms (link/jab LEDs),
- continuous transmissions—also known as jabber (link/jab LEDs).

You can use these LEDs to isolate defective building wiring, modular cords, cord connections, power transformers, and nodes.

Of the 14 LEDs shown in Figure 32, two LEDs (traffic and collision) indicate activity related to the Hub (not specific to any one connection). Included in the remaining 12 LEDs are the AUI jab LED and the link/jab LEDs. The AUI jab LED is associated with the AUI port, and the 11 link/jab LEDs are associated with each of the 11 modular jacks (one LED per jack/port).

FIGURE 32 Hub LEDs

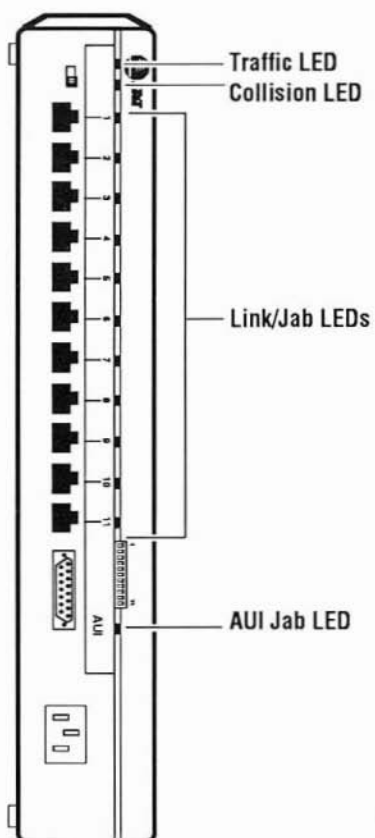

To better understand how traffic and collision LEDs reflect network activity, it is important for you to know how network signals travel through Hubs. A network signal enters the Hub through any port and is transmitted out through all other Hub ports (see Figure 33).

FIGURE 33 Traffic Traveling Through Hubs

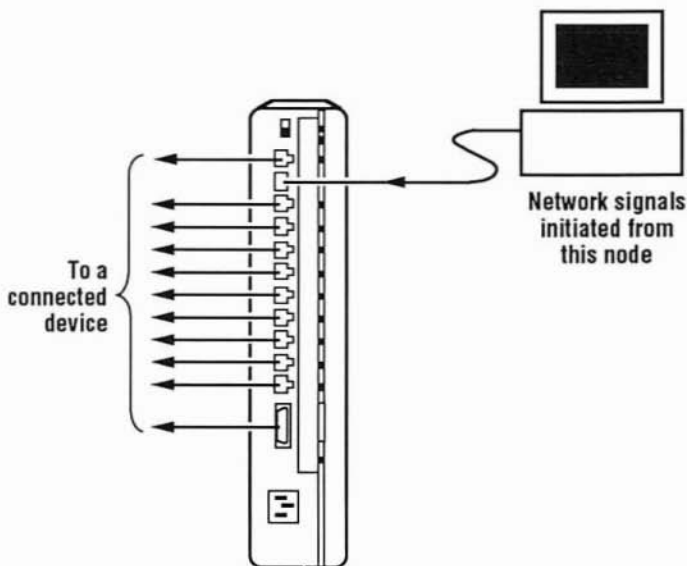

The following sections describe the functions of the Hub's LEDs and explain how to interpret their various states.

Traffic LED

The green LED located on the top right of the Hub (see Figure 34) indicates network traffic.

Under normal operating conditions, the traffic LED is ON when there is no traffic (and power is being supplied to the Hub) and blinks OFF to indicate the presence of traffic from a connected node or another Hub.

The traffic LED is useful as a troubleshooting aid, as indicated in the next section, "Traffic LED Indications."

FIGURE 34 Traffic LED

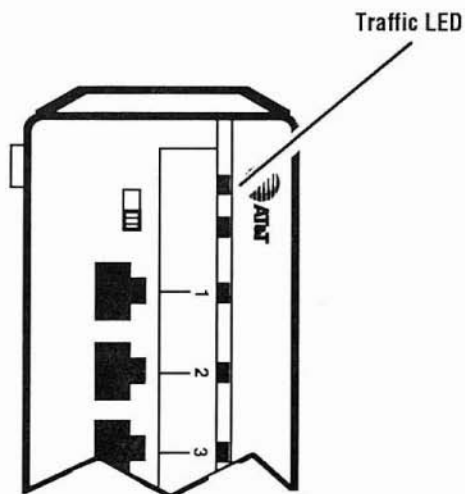

Traffic LED Indications

Table 5 lists the possible states of the traffic LED. Match the activity of the traffic LED on the Hub with one of the states indicated in the table.

TABLE 5 Traffic LED

<u>State</u>	<u>Indication</u>	<u>Interpretation</u>
Blink	Normal	Traffic received from any device connected to the Hub
On	Normal	No traffic, power on
Off	Problem	No power. (See "Note")

► Note

If the traffic LED is off, return the Hub to the original place of purchase. If you purchased the Hub from AT&T in the United States or Puerto Rico, call the toll-free AT&T National System Support Center hotline at 1-800-922-0354. In Canada, call the toll-free AT&T Canada, Inc. hotline at 1-800-387-0913. In all other countries, call your authorized AT&T dealer. ◀

Collision LED

The amber LED located on the top right of the Hub (see Figure 35) indicates collisions. This LED normally is OFF and blinks ON to indicate the presence of collisions.

A collision occurs when two nodes attempt to transmit on the network at the same time. When a collision occurs, both nodes recognize the collision, stop transmitting, wait a random amount of time, and attempt to retransmit. Collisions are normal occurrences on CSMA/CD networks; the more heavily used a StarLAN 10 Network is, the more often collisions will occur.

FIGURE 35 Collision LED

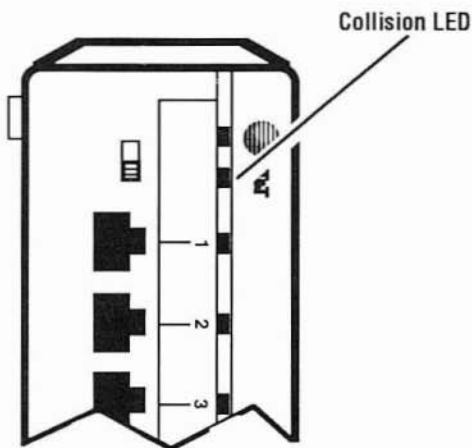

As the frequency of collisions on a network increases, the activity (on-time) of the LED also increases. If the collision LED becomes very active, you may want to make use of other network troubleshooting tools, such as the AT&T StarGROUP™ Software Network Manager or the NETSTAT command, to determine whether the network has reached capacity and may need to be separated into two networks connected by a bridge.

While the collision LED blinks to indicate normal network collisions, it also may be useful in troubleshooting certain problems related to network wiring. If the collision LED blinks when only one node connected to the Hub is active, there may be a wiring problem associated with that jack or port.

Typical wiring problems indicated by excessive activity of the collision LED include the following:

- a defective twisted-pair wire connected to a Hub jack or cross connect
- a defective connector
- a poor grade or wrong type of cable
- a twisted-pair wire that exceeds recommended length
- a twisted-pair wire that passes through or is bundled with an excessive source of high intensity noise
- a bridged tap
- a Medium Attachment Unit (MAU) connected to the AUI port without the SQE test function disabled

If none of these problems exist, the problem may be related to that jack or port on the Hub.

AUI Jab LED

The red LED located near the AUI port on the Hub (see Figure 36) indicates a jab condition. The AUI Jab LED is OFF under normal operating conditions and ON to indicate that a jab condition exists at the AUI port.

FIGURE 36 AUI Jab LED

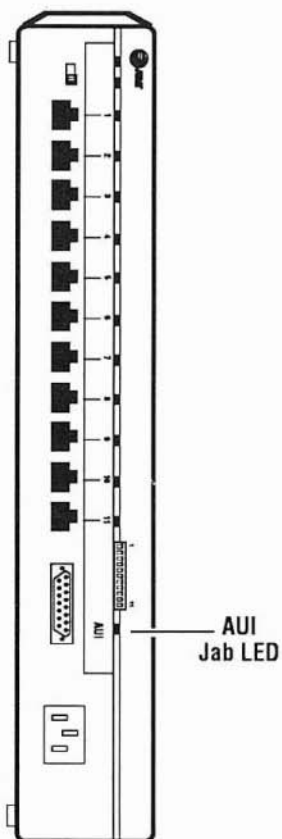

A jab condition exists when either of the following events is detected at the AUI port:

- The transmission of network signals exceeds the maximum allowable transmission time.
- Successive collisions are detected on a given connector (AUI port) without an intervening successful transmission or reception.

A jab condition may be caused by a faulty node or wiring connection. A typical faulty wiring condition would be a missing terminator on the coax segment attached to the AUI port.

When a jab condition is detected at the AUI port, the Hub automatically deactivates the AUI port's ability to receive incoming data. The jab condition is indicated at the AUI port by the ON state of the AUI jab LED. The hardware device (and consequently all devices connected to that hardware device) associated with the AUI port is temporarily disconnected from the network. The modular jacks and their associated devices are undisturbed and continue functioning normally.

When the cause of the jab condition has been corrected and a normal data packet is transmitted to or received from that AUI port without a collision, the AUI port is automatically reactivated and the LED is turned OFF.

Link/Jab LEDs

Link/Jab LEDs are multicolored (red, green, amber). A Link/Jab LED is located near each modular jack on the Hub (see Figure 37).

The Link/Jab LED indicates the presence of jab at the Hub's modular jacks (this function overrides the Link/Jab LED's Link Integrity indications). In the absence of jab, the Link/Jab LED indicates whether the Link Integrity is enabled. When Link Integrity is enabled, the Link/Jab LED verifies the integrity of the receive portion of the twisted-pair wire connection.

FIGURE 37 Link/Jab LEDs

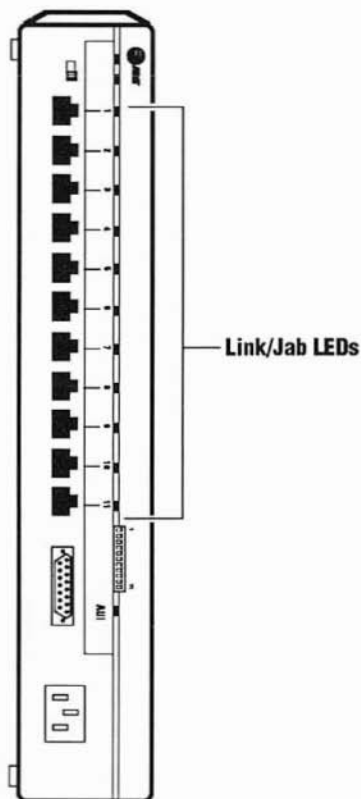

Under normal operating conditions, the Link/Jab LED will remain either ON GREEN (if Link Integrity is enabled and the link is good) or ON AMBER (if Link Integrity is disabled). The Link/Jab LED is OFF when its corresponding jack is not in use.

Use Table 6 to interpret the status of a Link/Jab LED that is connected to a device. Complete descriptions of jab and Link Integrity states appear following the table.

TABLE 6 States of the Link/Jab LED at Connected Jacks

<u>LED State</u>	<u>Description</u>
ON RED	A jab condition exists at the modular jack. This function overrides the Link/Jab LEDs Link Integrity Indications.
ON GREEN	Link Integrity is enabled and the receive portion of the link is good.
OFF	Link Integrity is enabled and one of the following conditions exist: <ul style="list-style-type: none">■ a problem exists with the connection to the twisted-pair wire device■ if the connected device is a Fiber Adapter with Link Integrity Pass Thru enabled, a problem may also exist in the connections between the fiber side of the adapter and the end device in the path.■ the connected device is powered OFF■ the Hub is not receiving power■ the LED is malfunctioning To test the LED, disconnect the twisted-pair wire jacks and perform the procedure in the the section entitled "Power-Up LED Test" earlier in this guide.
ON AMBER	Link Integrity is disabled.

Job Indications

The Link/Job LED will remain ON RED when a job condition exists at a modular jack. A job condition exists when either of the following events is detected at a modular jack:

- The number of successive collisions exceeds the maximum allowable number of successive collisions.
- The duration of a collision exceeds the maximum allowable duration for a collision.

A job condition may be caused by a faulty node or wiring condition (for example, an electrical short in a piece of twisted-pair wire).

When job is detected at one of the ports, the Hub automatically deactivates this port. The twisted-pair wire device connected to the port is disconnected temporarily from network. The remaining devices connected to other ports on the Hub are undisturbed and continue to function normally.

When the cause of the job has been corrected and a normal data packet is transmitted to the port, the port is automatically reactivated and the Link/Job LED returns to its previous state. Communication is automatically re-established between the twisted-pair wire device connected to the port and the rest of the network.

Link Integrity Indications

In the absence of jab and with Link Integrity enabled, the Link/Jab LED can provide the following indications:

- If the LED remains ON GREEN, the receive portion of the twisted-pair wire connection is good. Check the LED on the connected device to verify the integrity of the transmit portion.
- If the LED remains OFF, either a problem with the twisted-pair wire connection is indicated, or, if the Hub is connected to a Fiber Adapter with Link Integrity Pass Thru enabled, a problem may also exist in the connections between the fiber side of the adapter and the end device in the path.

Verify that both the Hub and the connected device are powered on and that the Link Integrity option switch has been set correctly on both devices. If the connected device is a Fiber Adapter, disable Pass Thru on the Adapter and check the Hub LED again. If the LED is now ON GREEN, the problem is on the fiber side of the adapter.

If the problem needs to be isolated further, check for an incomplete or incorrect twisted-pair wire connection between the devices (such as a loose modular cord or an OUT-OUT connection). If necessary, use a continuity tester or a time domain reflectometer (TDR) to test the twisted-pair wire for breaks or shorts. If a valid twisted-pair wire connection exists, one of the two devices may be defective.

In the absence of jab and with Link Integrity disabled, the Link/Jab LED should remain ON AMBER. This indicates that the Hub is receiving power. Note that this does not necessarily indicate a valid twisted-pair wire connection.

Hub Pin Assignments

The following illustrations indicate the pin assignments for modular jacks and the AUI port on the Hub. You may find this information helpful in troubleshooting networks comprised of equipment that has pin assignments different from those used in AT&T equipment.

FIGURE 38 RJ45 Connector

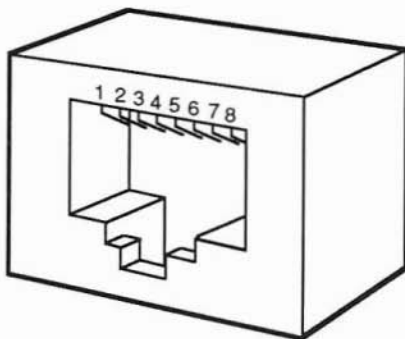

<u>Pin</u>	<u>OUT Jack Assignments</u>	<u>IN Jack Assignments</u>
1	OUTGOING DATA 1 (+)	INCOMING DATA 1 (+)
2	OUTGOING DATA 2 (-)	INCOMING DATA 2 (-)
3	INCOMING DATA 1 (+)	OUTGOING DATA 1 (+)
4	(No Connection)	(No Connection)
5	(No Connection)	(No Connection)
6	INCOMING DATA 2 (-)	OUTGOING DATA 2 (-)
7	(No Connection)	(No Connection)
8	(No Connection)	(No Connection)

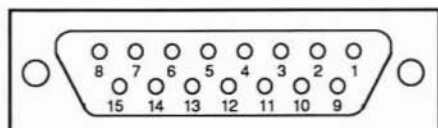
FIGURE 39 DTE D-type Connector

<u>Pin</u>	<u>Circuit</u>	<u>Use</u>
3	DO-A	Data Out Circuit A
10	DO-B	Data Out Circuit B
11	DO-S	Data Out Circuit Shield
5	DI-A	Data In Circuit A
12	DI-B	Data In Circuit B
4	DI-S	Data In Circuit Shield
7	CO-A	Control Out Circuit A
15	CO-B	Control Out Circuit B
8	CO-S	Control Out Circuit Shield
2	CI-A	Control In Circuit A
9	CI-B	Control In Circuit B
1	CI-S	Control In Circuit Shield
6	V _c	Voltage Common*
13	VP	Voltage Plus*
14	VS	Voltage Shield
Shell	PG	Protective Ground (Conductive Shell)

* Voltage Common and Voltage Plus use a single twisted-pair in the AUI cable.

Glossary

This section explains technical terms for readers unfamiliar with communications wiring environments and local area networks.

- 1A-Key system** The AT&T wiring system for the 6-button telephones called "1A-Key sets."
- 10BASE2** An IEEE Standard 802.3 for local area networks. Complying networks must be capable of carrying information at a rate of 10 Mbits/second over distances up to 606 feet (185 meters) of thin coaxial cable.
- 10BASE5** An IEEE Standard 802.3 for local area networks. Complying networks must be capable of carrying information at a rate of 10 Mbits/second over distances up to 1640 feet (500 meters) of thick coaxial cable.
- 10BASE-T** A draft standard of the ANSI/IEEE Standard 802.3 for LANs compatible with Ethernet networks on unshielded twisted-pair wire.
- 66-type wiring environment** An older AT&T wiring system, now being replaced by the 110-type, in which a special tool must be used to attach to the cross connect the twisted-pairs from telephones, nodes, and other communications devices.
- 110-type wiring environment** Also called "Premises Distribution System" (PDS). The AT&T wiring system in which the telephones, nodes, and other communications devices can be easily added and rearranged with modular wiring components and patch cords.

802.3	An IEEE standard for local area networks based on bus configuration and Carrier Sense Multiple Access with Collision Detection (CSMA/CD) (includes 1BASE5, 10BASE2, and 10BASE5).
adapter	A device that supports the interconnection of different sizes or types of plugs.
Attachment Unit Interface (AUI)	The interface between the Medium Attachment Unit and a node within a local area network.
bridged tap	A cable (or cord) connected to another cable (or cord) at a point other than its end. Such a tap causes impairment of network signal transmissions.
coaxial cable	A cable with at least one transmission line consisting of two conductors, an inner conductor and an outer conductor, insulated from one another by a dielectric. Coaxial cable carries higher frequencies than twisted-pair cable and offers a broader bandwidth. It is commonly used to transmit video signals, but can also be used for certain high speed data applications.
collision	A condition that occurs when two nodes attempt to transmit on the network at the same time. When a collision occurs, both nodes recognize the collision, stop transmission, wait for a random time interval, and then attempt to retransmit.
collision storm	An excessive amount of consecutive collisions on a port indicating a potential problem with the wiring connection or a faulty node.
conductor	A medium such as copper wire that can carry electrical current.
configuration	The layout of nodes and components in the network.

cross connect	A panel on which the leads of station cable are mounted so that an AT&T technician, other wiring craftsperson, or the system administrator can make electrical connections between the communications devices wired to the cables.
DCE	Data communication equipment.
DTE	Data terminal equipment.
equipment room	An enclosed space where voice and data common equipment circuit administration is performed.
Ethernet	A 10 Mbits/second Carrier Sense Multiple Access with Collision Detection (CSMA/CD) local area network on coaxial cable.
Ethernet transceiver	A device used in an Ethernet local area network to couple data terminal equipment to the transmission medium.
Fiber Adapter	A hardware device used to convert StarLAN 10 Network signals between electrical signals transmitted on twisted-pair wire medium and light pulses transmitted on optical fiber medium.
Hub	A device used to provide connectivity between data terminal equipment in a StarLAN 10 Network. Each Hub provides connections for up to 12 hardware devices: 11 modular jacks (10 dedicated IN jacks and 1 switchable IN/OUT jack) and an AUI port.
jab	A condition where a port is disconnected from the network as a result of the detection of jabber or a collision storm on that port.
jabber	A condition where the transmission of network signals exceeds the maximum allowable transmission time. Jabber may be caused by a faulty node or wiring connection.
LED	Light emitting diode.

Link Integrity function	A generated signal that verifies continuity between twisted-pair wire devices.
local area network (LAN)	A data communications network consisting of host computers or other equipment interconnected to terminal devices, such as personal computers, often via twisted-pair wire or coaxial cable. Typically, the network is limited to a single premise.
Medium Attachment Unit (MAU)	A device used in a data station to couple the data terminal equipment to the transmission medium.
megabit (Mbit)	One million bits.
modular cord	A cord containing four twisted pairs of wires, with a modular plug on one or both ends.
Network Access Unit (NAU)	A plug-in expansion board that enables StarLAN 10 Network nodes to send and receive data through the network.
node	A Network Access Unit or an AT&T Information Systems Network (ISN) StarLAN Interface Module (SLIM).
optical fiber	A transmission medium consisting of a core of glass surrounded by strengthening material and a protective jacket. Signals are transmitted as light pulses and introduced into the optical fiber by a laser or light emitting diode.
plenum cord	Communications cord with fire-retardant insulation, generally used in suspended ceilings and other places where air circulates back to the building's air-conditioning system.
port	On a network device, an outlet where other devices may be connected. For example, the AUI port and modular jacks on the StarLAN 10 Network Hub.
primary Hub	The Hub to which all other Hubs in a room or wiring closet are connected. If a room or a wiring closet has only one Hub, it also is considered a primary Hub.

secondary Hub	Any Hub whose OUT jack is connected to an IN jack of a primary Hub in the same room or wiring closet.
tip/ring system	The AT&T wiring environment that designates <i>tip</i> and <i>ring</i> as the functions of two conductors within each wire group of a 25-pair station cable.
transceiver cable	A cable used to connect two hardware devices: one having a D-type DCE connector and the other having a D-type DTE connector. Also called "AUI cable."
twisted-pair wire	Two insulated copper wires twisted together. The twists are varied in length to reduce the potential for signal interference between pairs. In cables greater than 25 pairs, the twisted-pairs are grouped and bound together in a common cable sheath. Twisted-pair cable is the most common of transmission media.
wall jack	Also called "connecting block," "modular wall outlet," or "information outlet." A receptacle used with a modular plug to make electrical contact between circuits and communications devices, such as telephones and nodes.
wiring block	The part of the 110-type cross connect that terminates twisted pair wiring and can be used with either jumper wires or patch cords to establish circuit connections.
wiring closet	A room, closet, or cabinet where station cable is terminated on cross connect blocks and where the building communications system can be administered.
wiring environment	Any building communications wiring system. See also 110-type wiring environment and 66-type wiring environment .

Index

A

- Adapters
 - description, 17
 - definition, 96
- AT&T
 - for design or installation, 9
 - for help, 9
 - for product information, 9
 - hotline, 9
- Attachment Unit Interface. *See* AUI
- AUI, 3, 96
- AUI Adapter modular cord length, 30
- AUI cable. *See* Transceiver cable
- AUI Jab LED, 86
- AUI port, 3, 47

B

- Bracket for mounting, 36
- Bridge tap, 85
- Broadband, 1
- Broadband Hub connections, 3
- Building-to-building
 - configuration, 28
 - connection, 75

C

- Cable
 - 25-pair, 62
 - transceiver, 1
- Closet
 - connecting nodes, 66
 - specifications, 34
- Coaxial cable, 96
- Coaxial Hub connections, 3
- Collision, 96
- Collision LED, 84
- Collision storm, 5, 96
- Conductor, 96

Configuration

- definition, 96
 - hierarchy, 19
 - Hub, 19
 - star, 1
- ## Connecting
- a Hub in a room to a wiring closet, 65
 - a Hub in a wiring closet to a Hub in another wiring closet, 66
 - a Hub in one building to a Hub in another building, 75
 - form, 11
 - multiple Hubs, 50, 55
 - rules, 47
 - verification, 77
- ## Cords. *See* Modular cord
- Cross connect, 85, 97
 - CSMA/CD, 1

D

- D8W cord, 16, 55
- Design considerations, 11
- Distance guidelines, 30
- Distances for cord length, 33
- DP8B-DE cord, 16
- DW8A-DE cord, 16, 52, 55, 63, 65, 66
- DW8A-SE cord, 16, 62, 64, 68

E

- Equipment room, 19, 97
- Ethernet, 97
- Ethernet transceiver
 - cable length, 30
 - definition, 97
- Extension cord, 17, 33

F

- Fiber Adapter, 17, 25, 28, 30, 71

H

- Hardware device, 1
- Hotline, 9
- Hub
 - configurations, 19
 - connecting rules, 47
 - definition, 97
 - dimensions, 34
 - functions, 1, 3
 - kit, 11, 14
 - labeling, 45
 - LEDs, 79
 - locations, 20
 - modular cord length, 30
 - mounting, 31
 - operating environment, 32
 - placement, 31
- Hub connections
 - between buildings, 75
 - broadband, 3
 - coaxial, 3
 - general rules, 47
 - optical fiber, 3, 66, 71, 75
 - twisted-pair wiring, 3
 - verifying, 77

I

- Identifying a wiring environment, 58
- IEEE Standard 802.3, 1
- IN jack
 - connection, 47, 63, 66, 72
 - jab, 79
 - jabber, 5
 - prewiring, 3
- IN/OUT jack connection, 47
- Installation
 - connections, 47
 - design form, 11
 - labeling, 45
 - mounting, 36

J

- Jab, 87, 97
- Jab condition, 5, 87, 90
- Jab condition isolation, 5, 87, 90
- Jabber, 5, 79, 97

K

- Kit, 7, 11, 14

L

- Labeling Hubs, 45
- LAN, 1, 98
- LEDs
 - AUI Jab, 86
 - collision, 84
 - Link/Jab, 88
 - testing, 41
 - traffic, 82
- Light Emitting Diodes. *See* LEDs
- Link Integrity, 5, 88
- Link/Jab LED, 88
- Local area network. *See* LAN

M

- Media, 1
- Megabit, 98
- Modular cord
 - connections, 47
 - definition, 98
 - lengths, 16
 - table, 16
- Modular wall jack, 3, 23
- Mounting
 - Hubs, 36
 - requirements, 31
- Multiple wiring closets, 25

N

- NAU, 98
- Network configurations, 20
- Network design, 11
- Network signals, 1, 5, 81
- Network traffic, 81
- Node
 - definition, 98
 - modular cord length, 30

O

- 1A-Key system
 - definition, 95
 - wiring environment, 59
- 110-type cross connect, 58
- 110-type wiring environment, 95
- Optical fiber
 - configuration, 25, 28
 - definition, 98
 - Hub connections, 3, 66, 71, 75
 - transceiver, 1

P

- Placement considerations, 32
- Plenum cord, 16, 98
- Power cable, 40
- Power requirements, 33
- Power strip, 17
- Prewiring, 3
- Primary Hub
 - definition, 98
 - labeling, 45

R

- Requirements, 31
- Room
 - configuration, 22
 - connections, 51
 - specifications, 34

S

- Secondary Hubs
 - definition, 99
 - labeling, 45
- 66-type cross connect, 58
- 66-type wiring environment, 95
- Star configuration, 1
- StarLAN 10 Network, 1
- Switchable IN/OUT jack, 47

T

- 10BASE2, 1, 95
- 10BASE5, 1, 95
- 10BASE-T, 1, 95
- Testing LEDs, 41
- Tip/Ring
 - definition, 99
 - wiring environment, 59
- Tools for mounting, 36
- Traffic, 81
- Traffic LED, 82
- Transceiver, 97
- Transceiver cable, 1, 16, 30, 99
- Twisted-pair wire, 1, 3, 99

V

- Verifying connections, 77

W

- Wall jack, 3, 99
- Wiring block, 63, 99

- Wiring closet
 - configuration, 23
 - connections, 57
 - definition, 99
 - hierarchy, 19
 - See also* Closet
- Wiring environment
 - definition, 99
 - 110-type, 95
 - 66-type, 95

999-120-722
Issue 1

Graphics © AT&T 1988

