

USED COMPUTERS AND HARDWARE

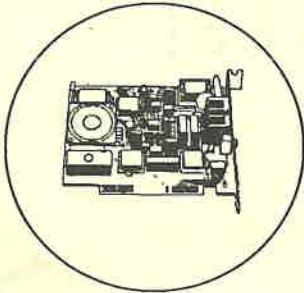

PARTS
AND
ACCESSORIES

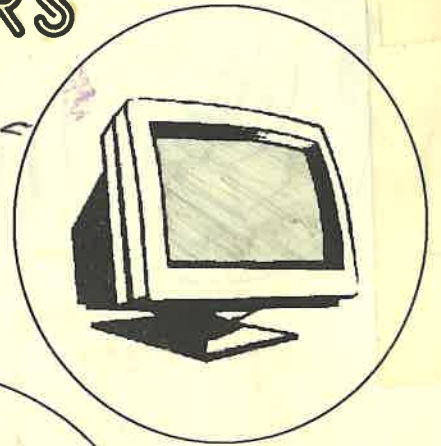
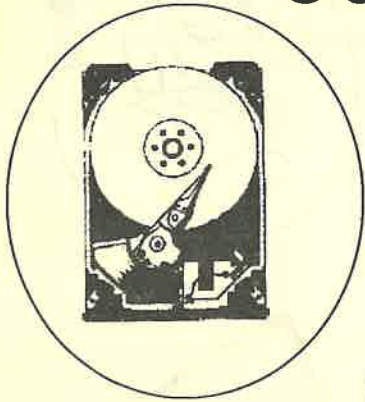
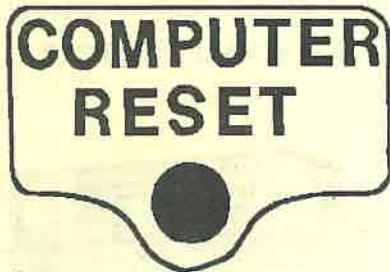

P.O. Box 461782
Garland, TX 75046-1782
VOICE (214) 276-8072
FAX/BBS (214) 272-7920

New and Used Computers
and Accessories

IBM PCjr & Convertible
Upgrades, Parts,
& Accessories



FALL/WINTER USED COMPUTER SPECIALS!



**IBM PC
MODEL 5150**

\$99

256K RAM
1 360K FLOPPY DRIVE
KEYBOARD
MONOCHROME MONITOR*

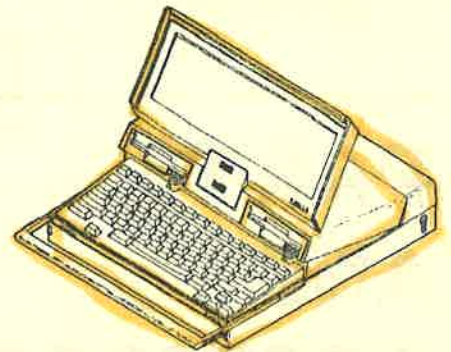

**IBM PC CONVERTIBLE
MODEL 5140**

\$349

512K RAM
2 - 720K FLOPPY DRIVES
ATTACHABLE PRINTER

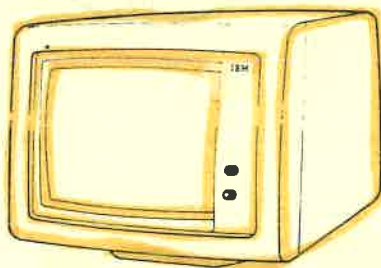

**IBM 5151
MONOCHROME MONITOR**
TTL INPUT - GREEN SCREEN
12" DIAGONAL SCREEN SIZE

\$25 WITH BURNED SCREEN
\$49 WITH CLEAR SCREEN

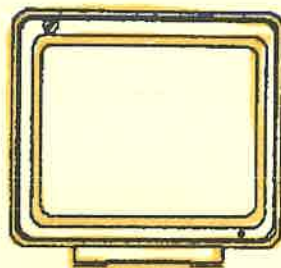

**IBM 8512
COLOR VGA MONITOR**
640X480 RESOLUTION
14" DIAGONAL SCREEN SIZE

\$159

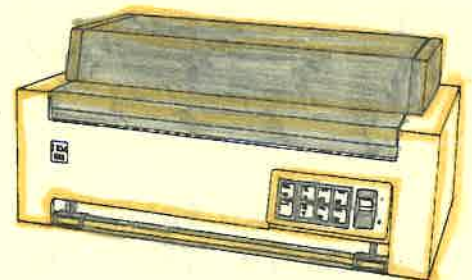

**\$199
IBM 5182
COLOR PRINTER**
132-COLUMN
200 CPS DRAFT
35 CPS NLQ
4 OR 8 COLORS

Used, Demo and Refurbished Computers *



AT&T

- PC6300 \$ 369
- 8086, 8 Mhz, 256K RAM, 1 (360K)FD, Kbd
- PC6300 \$ 449
- 8086, 8 Mhz, 256K RAM,,1 (360K)FD, Kbd
- Add a Monochrome Monitor for \$ 79

APPLE

- Iie 64K Computer Only \$ 229
- Iie 128K Computer \$ 449
- 2 Floppy Drives, Mono Monitor

COMPAQ PORTABLE

- Portable I \$ 229
- 8088, 4.7 Mhz, 256K, 2(360K)FD, 9" Monitor
- Portable + \$ 349
- 8088, 4.7 Mhz, 256K, 1(360K)FD,
- 10 Meg HD, 9" Mono Monitor
- Portable II \$ 549
- 80286-8 640K, 2(360K)FD, 9" Mono Monitor
- Portable II \$ 689
- 80286-8, 640K, 1(360K)FD, 20 Meg HD,
- 9" Built In Monochrome Monitor
- Portable 286 \$ 469
- 80286-8 640K, 1(360K)FD,
- Built in 9" Monochrome Monitor
- Portable 286 \$ 599
- 80286-8, 640K, 1(360K)FD, 20 Meg HD,
- 9" Built In Monochrome Monitor
- Portable III \$ CALL
- 80286-10, 640K, 1(1.2 Mb)FD, 20 Meg to 100
- Meg Hard drive Built in GAS Plasma Screen,
- Lunch Box Style Case.
- Portable 386 \$ CALL
- 80386-20, 1 Meg, 1(1.2 Mb)FD, 20 Meg to 100
- Meg Hard drive, Built in Gas Plasma Screen
- Lunch Box Style Case
- SLT Series \$ CALL
- LTE Series \$ CALL
- 8086, 80286 & 80386 Notebook Style

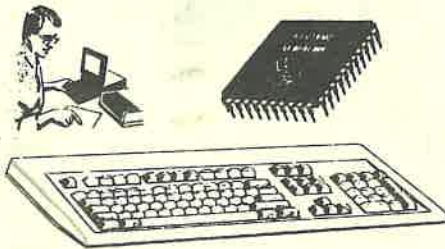

COMPAQ DESKTOP

- Tellacomputer \$ 329
- 8088, 258K, 3(360K) FD, Telephone, Modem
- Built in 9" Mono Monitor Built In
- DskPro 8088 \$ 179
- 256K RAM, 2 (360K) FD, Kbd
- DskPro 286/12 \$ 529
- 80286-12, 640K RAM, 1(1.2Mb)FD, Kbd
- DskPro 286/12 Mod 20 \$ 599
- 80286-12, 1(1.2Mb)FD, 640K RAM,
- 20 Meg Hard Drive, Kbd
- DskPro 286/12 Mod 40 \$ 675
- 80286-12, 1(1.2Mb)FD, 640K RAM,
- 40 Meg Hard Drive, Kbd
- Dskpro 286e-1 \$ 579
- 80286-12, 1(1.2Mb)FD, 1 Meg RAM, Kbd
- DskPro 286e-40 \$ 769
- 80286-12, 1(1.2Mb)FD, 1 Meg RAM,
- 40 Meg Hard Drive, Kbd
- Dskpro 286n-1 \$ 599
- 80286-12, 1(1.2Mb)FD, 1 Meg RAM, Kbd
- DskPro 286n-40 \$ 789
- 80286-12, 1(1.2Mb)FD, 1 Meg RAM,
- 40 Meg Hard Drive, Kbd
- DskPro 386/16 \$ CALL
- 80386-16, 1(1.2Mb)FD, 640K RAM,
- XX Meg Hard Drive, Kbd
- DskPro 386/20 \$ CALL
- 80386-20, 1(1.2Mb)FD, 1 MEG RAM,
- XX Meg Hard Drive, Kbd
- DskPro 386/25 \$ CALL
- 80386-25, 1(1.2Mb)FD, 1 MEG RAM,
- XX Meg Hard Drive, Kbd



IBM PORTABLES \$179

- Portable 5155 -1
- 8088, 256K RAM, 1 (360K) FD, Kbd,
- 9" Built In Amber Monitor.
- 5140 Convertible - 002 \$ 349
- 8088, 512K RAM, 2(720K) FD, Enhanced
- LCD Screen, Printer, Carrying Case.
- 5140 Convertible - 003 "NEW" \$ 849
- 8088, 640K RAM, 2(720K) FD, Backlit
- LCD Screen, AC Adapter.

IBM DESK TOP

- 4860 PCjr \$ 169
- 128K RAM, 1(360K) FD, Kbd
- 5150-166 PC \$ 99
- 256K RAM, 1(360K) FD, Kbd, 5151
- Mono Monitor (with imperfect screen)
- 5150-176 PC \$ 149
- 256K RAM, 2(360K) FD, Kbd, 5151
- Mono Monitor (with imperfect screen)
- 5160-086 PC/XT \$ 159
- 256K RAM, 1(360K) FD, Kbd, 5151
- Mono Monitor (with imperfect screen)
- 5160-078 PC/XT \$ 179
- 256K RAM, 2(360K) FD, Kbd, 5151
- Mono Monitor (with imperfect screen)
- 5160-086 PC/XT \$ 279
- 256K RAM, 1(360K) FD, 10 Meg Hard Drive,
- 101 Key Enhanced Kbd, 5151 Monochrome
- Monitor (with imperfect screen)
- 5160-089 PC/XT \$ 359
- 640K RAM, 1(360K) FD, 20 Meg Hard Drive,
- 101 Key Enhanced Kbd, 5151 Monochrome
- Monitor (with imperfect screen)
- 5160-268 PC/XT \$ 299
- 640K RAM, 2(360K) FD, 101 Key Enhanced
- Kbd 5151 Monochrome Monitor (with im-
- perfect screen)

- 5170-068 PC/AT \$199
- 80286, 512K RAM, 1.2 Mb Fd, Ser/Par,
- Kbd (no video card) ~~\$ 399~~
- 5170-099 PC/AT \$ 495
- 80286, 512K RAM, 1.2 Mb Fd, 20 Meg
- Hard Drive, Ser/Par, Kbd (no video card)
- 5170-239 PC/AT \$ 539
- 80286, 512K RAM, 1.2 Mb Fd, 30 Meg
- Hard Drive, Ser/Par, Kbd (no video card)
- 5170-339 PC/AT \$ 599
- 80286, 512K RAM, 1.2 Mb Fd, 30 Meg
- Hard Drive, Ser/Par, Kbd (no video card)
- 5170-339 PC/AT "NEW" \$ 1100
- 80286, 512K RAM, 1.2 Mb Fd, 30 Meg
- Hard Drive, Ser/Par, Kbd (no video card)
- 5170-Tempest "SPY Proof" \$ 999
- Shielded System, 640K RAM, 2(360K)FD,
- 2 Cartridge Drives, Kbd (This is a relic from
- the Cold WAR and has extensive shielding to
- prevent radiation emissions from the computer)

IBM RT "Tempest - SPY Proof"

- Shielded System, CPU Only \$ 1895



IBM PS/2 Computers

- 47xx PS/2 Executive Workstation \$ 599
- 8686, 640K RAM, 1(720K)FD, 101 Key Kbd,
- Drive Lock, Attached MCGA Monochrome
- Monitor (performs like PS/2 Mod 30 only smaller in
- size)
- 8525-001 \$ 429
- 8088, 512K RAM, 1(720K) FD, Key Bd
- 12" B/W Mono Monitor
- 8525-G01 \$ 479
- 8088, 512K RAM, 2(720K) FD, Key Bd
- 12" B/W Mono Monitor

A

B

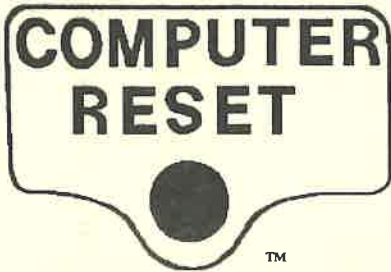

Used Computers

Monitors & Printers

Why Buy New ?? ... When Used Will DO !! TM

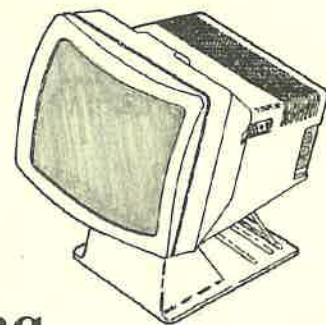
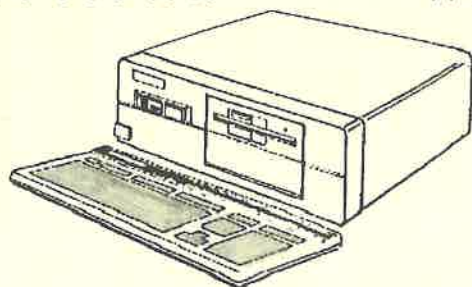

**Major Brand Names - IBM, Compaq
Okidata, Toshiba, & Many Others**

**Specializing in parts & accessories for the
IBM PCjr, Convertible, PC, PC/XT, PC/AT**

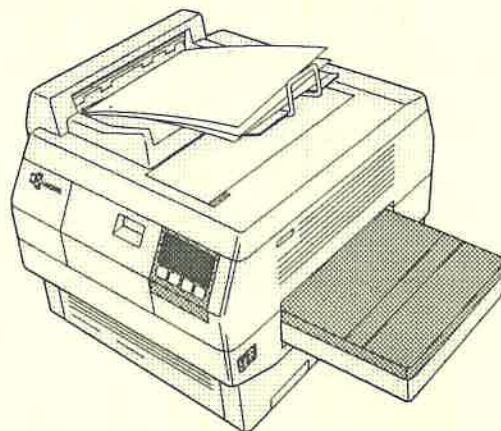
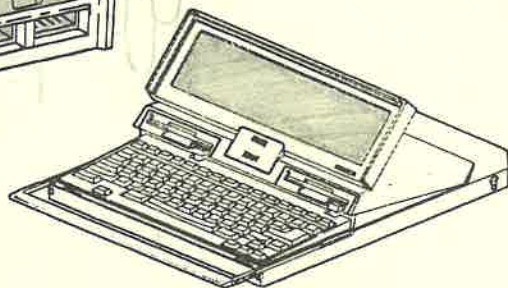
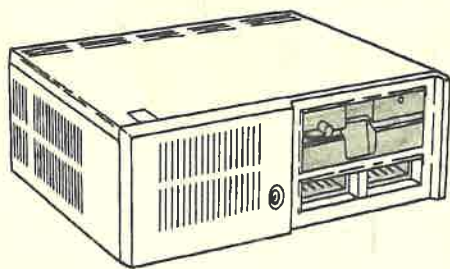

**The Place to get dependable Refurbished
IBM & Compatible computers That Work
for You As Good As New ...
Service Parts, Repairs and Upgrades**



8525-004 \$ 549
 8088, 512K RAM, 1(720K) FD, Key Bd
 12" Color (MGCA Graphics) Monitor
 8525-GO4 \$ 599
 8088, 512K RAM, 1(720K) FD, Key Bd
 12" Color (MGCA Graphics) Monitor

8530-001 \$ 195
 8086, 512K RAM, 1(720K)FD, Kbd
 8530-002 \$ 249
 8086, 640K RAM, 1(720K)FD, Kbd
 8530-021 \$ 469
 8086, 512K RAM, 1(720K)FD, 20 Meg HD,
 Kbd

Note: The 8530 is an XT Class Machine including 3 of the 8 Bit expansion Slots.

8530-E01 \$ 469
 80286-10, 1 Meg RAM, 1(1.44MB)FD, Kbd
 8530-E21 \$ 499
 80286-10, 1 Meg RAM, 1(1.44MB)FD,
 20 Meg Hard Drive, Kbd
 8530-E31 \$ 599

80286-10, 1 Meg RAM, 1(1.44MB)FD,
 30 Meg Hard Drive, Kbd
 Note: The 8530 is a 286 or AT type computer with 3 of the 16 bit expansion slots.

8550-021 \$ 599
 80286-10, 1 Meg RAM, 1(1.44MB)FD,
 20 Meg Hard Drive, Kbd
 8530-031 \$ 649
 80286-10, 1 Meg RAM, 1(1.44MB)FD,
 30 Meg Hard Drive, Kbd

8530-061 \$ 749
 80286-10, 1 Meg RAM, 1(1.44MB)FD,
 60 Meg Hard Drive, Kbd
 Note: The 8550 is a MICROCHANNEL Bus Machine having 3 expansion Slots

8555-031 \$ 1129
 80386SX/16, 2 Meg RAM, 1(1.44MB)FD,
 30 Meg Hard Drive, Kbd
 8555-041 \$ 1179
 80386SX/16, 2 Meg RAM, 1(1.44MB)FD,
 40 Meg Hard Drive, Kbd
 8555-061 \$ 1199

80386SX/16, 2 Meg RAM, 1(1.44MB)FD,
 60 Meg Hard Drive, Kbd
 Note: The 8555 is a 386 S/X 16 Mhz Desktop MICROCHANNEL Bus Machine having 3 Slots



8560-041 10 MHz \$ 649
 80286-10, 2 Meg RAM, 1(1.44MB)FD,
 44 Meg Hard Drive, Kbd
 8560-071 \$ 779
 80286-10, 2 Meg RAM, 1(1.44MB)FD,
 70 Meg Hard Drive, Kbd
 Note: The 8560 is a 286 or AT Type computer with the MICROCHANNEL Bus Architecture having 3 Slots and a Vertical floor Standing case.

8565-061 \$ 1049
 80386-16, 2 Meg RAM, 1(1.44MB)FD,
 60 Meg Hard Drive, Kbd
 8565-121 \$ 1169
 80386SX/16, 2 Meg RAM, 1(1.44MB)FD,
 60 Meg Hard Drive, Kbd
 Note: The 8565 is a 286 or AT Type desk top style computer with the MICROCHANNEL Bus Architecture having 3 expansion Slots.

8570-E61 \$ 1379
 80386-16, 2 Meg RAM, 1(1.44MB)FD,
 60 Meg Hard Drive, Kbd
 8570-061 \$ 1579
 80386-20, 2 Meg RAM, 1(1.44MB)FD,
 60 Meg Hard Drive, Kbd
 8570-121 \$ 1779
 80386-20, 2 Meg RAM, 1(1.44MB)FD,
 120 Meg Hard Drive, Kbd
 Note: The 8570 is a 386 Type desk top style computer with the MICROCHANNEL Bus Architecture having 3 expansion Slots.

8580-041 \$ 1529
 80386-16, 1 Meg RAM, 1(1.44MB)FD,
 44 Meg Hard Drive, Kbd

8580-071 16 MHz \$ 1679
 80386-16, 2 Meg RAM, 1(1.44MB)FD,
 70 Meg Hard Drive, Kbd
 8580-111 \$ 2479
 80386-20, 2 Meg RAM, 1(1.44MB)FD,
 115 Meg Hard Drive, Kbd
 8580-311 \$ 2979
 80386-20, 2 Meg RAM, 1(1.44MB)FD,
 315 Meg Hard Drive, Kbd
 Note: The 8580 is a 386 Type vertical standing style computer with the MICROCHANNEL Bus Architecture having 7 expansion Slots.

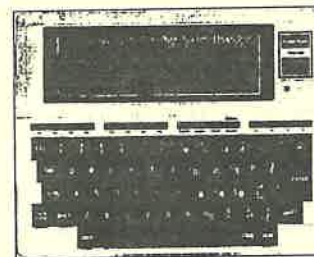

TANDY
 Model 3 2(180K)FD *Not Working* \$ 59
 Model 100 Notebook \$ 199
 32K RAM, 128K Bubble Memory, Built in Word Processor, Scheduler, Address Keeper, BASIC & Telecommunications. See the full page on description of this unique computer. (Shown Above)
 Model 600 Laptop \$ 395
 Model 1000 Desktop \$ 99
 8086, 256K RAM, 1 (360K)FD, Kbd, CGA Video (No Monitor)

TOSHIBA LAP TOP
 T1200H \$ 549
 8088-10, 1 Meg RAM, 1(720K)FD, 20 Meg Hard Drive, LCD Screen, Serial, Parallel, CGA Video Output, and 2400 Baud Modem

MISCELLANEOUS \$ 299
 Compatible XT
 640K, 1(360K)FD, 20Meg HD, Kbd and, Monochrome Monitor

Compatible AT \$ 349
 640K, 1(360K)FD, 20 Meg HD, Kbd Color CGA Monitor

WISE PC-3216, \$ 299
 386CPU, 16Mhz 1Meg, 1(1.2Mb)FD, Ser/Par, Kbd - Like New

Notice:
 Our stock of used computers varies constantly so call if you have some specific request.

* Computers listed herein are subject to availability. The price may change without notice. Due to the extensive variation of computer models and types some items may not be stocked at all times in which case we will try to locate for you the specific model you need as a special order.

PC Inside UPGRADE

If you own an IBM PC/XT or PC/AT or an IBM compatible computer we can upgrade the System board to a 386 DX 40 Mhz type and use many of the existing parts for a SUPER increase in performance enabling use of larger more complex DOS programs and the much acclaimed Microsoft Windows operating system

Cost \$ 279 for New System Board - Installed in your computer. (Without RAM)
 RAM Prices vary from time to time so call for an exact quotation when you are ready to upgrade (Minimum of 1 Meg Required for operation 4 Meg Minimum recommended for use of Microsoft Windows)

Shipping to and from our location is not included. Depending upon your specific computer some other parts may be needed to accomplish the upgrade.

D

E

Used, Demo and Refurbished Monitors

MONOCHROME

White, Amber & Green Screen Colors

| | |
|-----------------------|---------|
| AMDEK 300A or G | \$ 65 |
| APPLE II | \$ 125 |
| APPLE III | \$ 75 |
| APPLE IIc | \$ CALL |
| AT&T 313 Green "Used" | \$ 95 |

| | |
|---------------------------------------------------------|--------|
| COMPAQ DSM Green "Used" | \$ 49 |
| COMPAQ DSM Amber "Used" | \$ 49 |
| COMPAQ DSM Amber "NEW" | \$ 99 |
| COMPAQ Portable computer Monitor Assy 9" Green "NEW" | \$ 149 |

IBM 5144 9" Green "NEW" **\$59**
Composite Input (RCA Phono Jack) Made for the IBM Convertible but usable on the IBM PCjr, Apple II series and Compatibles, Many Laptop Computers and Regular PC's with the composite output. May be used for any NTSC video application. **\$49**

| | |
|-----------------------------------------------------------|---------|
| IBM 5151 Green TTL (same with slight screen burn) | \$ 25 |
| IBM 5151 Tempest "SPY Proof" | \$ 159 |
| IBM 5155 Portable computer Monitor Assy 9" Amber | \$ 99 |
| IBM 4707 9" VGA, White | \$ CALL |
| IBM 8503 12" VGA, White (same with slight screen burn) | \$ 69 |
| Tilt & Swivel Base for 8503, Add | \$ 9 |

MONITERM Viking VY-1000 19" \$ 489
Superb for desk top publishing use, Black & White screen includes Special Video Card

| | |
|----------------------------------------------|-------|
| MISC Brands TTL Monochrome Green or Amber | \$ 49 |
| MISC Brands VGA Monochrome | \$ 89 |
| QUADRANT Amber or white | \$ 89 |
| SAMSUNG 12" Amber | \$ 49 |
| SAMSUNG 12" Green | \$ 49 |
| TELEX TTL Green | \$ 49 |

TERMINALS

| | |
|-----------------------|--------|
| WYSE 50 Terminal, Kbd | \$ 199 |
| WYSE 60 Terminal, Kbd | \$ 249 |

COLOR MONITORS

CGA, EGA, PGA, & VGA

| | |
|------------------------------|---------|
| AT&T 318 | \$ 179 |
| EGA Color for AT&T Computers | |
| AT&T 319 & 329 | \$ CALL |
| AMDEK 350 Hi Res EGA+ | \$ 349 |
| AMDEK 622 EGA | \$ 199 |

| | |
|------------------------------------------------------------------------------------------------------------------------------------------------------|--------|
| IBM 4863 CGA for the PCjr (plug compatible to PCjr & Convertible) | \$ 169 |
| IBM 5145 13" CGA Color "NEW" (plug compatible to PCjr & Convertible) | \$ 109 |
| IBM 5145 13" CGA "NEW" (with 9-Pin Connector permitting use on computers with 9-pin CGA Video outout such as older PC's & many laptop computers.) | \$ 129 |

| | |
|----------------------------------------------|--------|
| IBM 5154 EGA (same with some screen burn) | \$ 299 |
| IBM 5154 Tempest EGA | \$ 199 |
| "SPY Proof" is extensively shielded | \$ 599 |

| | |
|--------------------------------------------------------------------------------------------------------------------|--------|
| IBM 5175 PGA (PGA is Professional Graphics Adapter and it is supported by some older high resolution software.) | \$ 399 |
| IBM PGA Video Card | \$ 129 |
| 5175 Monitor & Card together | \$ 499 |
| IBM 5175 Modified to VGA | \$ 199 |

| | |
|-------------------------------------------------------------------------------------------|--------------|
| IBM 8512 VGA 14", .31 Dot Pitch, 600X800 Res | \$159 |
| IBM 8513 VGA 12", .28 Dot Pitch, 640x480 Res | \$ 199 |
| IBM 8514 VGA 16", .28 dot Pitch, 1024X768 Res | \$ CALL |
| Tilt & Swivel Base is not included for 8512 Add \$ 19 for 8513 Add \$ 9 for 8514 \$ 45 | |

MISCELLANEOUS Brands \$ CALL
our stock of used & recondioed CGA, EGA, & VGA Monitors varies constantly Please callfor availability on items you want.

Notice:

All monitors are used and reconditioned unless noted. Our stock is limited to items on hand. Some Items are out of stock but are available on short notice - Call for information.

Brand New - Low Cost GENUINE IBM MONITORS!

We have a large quantity of New - In - The - Box genuine IBM monitors.
Choose from a Color Graphics (CGA) Monitor, or
Composite Monochrome monitor at our special sale prices!



Color Graphics (CGA) Monitor was original-ly made for the IBM PC Convertible laptop computer. The signal cable plugs directly into a Convertible CRT adapter or a PCjr.

Display is standard CGA colors, resolution is 320X200, screen is a 14-inch diagonal with a 3-position tilt base.

Available with a standard 9-pin CGA male D-shell connector for use with other IBM or compatible computers with a standard CGA output. Note the prices below.

IBM 5145 CGA Monitor* \$ 109
(*Includes instructions for 9-pin modification - soldering required!)

Monitor with 9-pin Modification \$ 129

A green phosphur Monochrome Monitor with a composite type input. It has a very readable 9-inch diagonal screen, and is mounted on a pedestal with tilt adjustment.

Included is a removable anti-glare shield and a shielded RCA male-to-male cable for connecting it to a composite video source, such as the one found on the Convertible CRT Adapter, the PCjr, and many lap top computers.

IBM 5144 Monitor \$ 59

CGA video card with both the 9-Pin CGA output and the RCA Phono Jack composite output are available for \$ 35



F

G

Used, Demo and Refurbished Printers

DOT MATRIX

Impact Type Printers

AMT 2030 \$ 389
18 Pin High Quality, Wide Carriage, Heavy Duty, Color Printer - Plotter Emulates Epson, NEC, Diablo, and the IBM 5182.

EPSON FX-286e \$ 255
240 CPS & NLQ wide carriage 9 pin, (Sheetfeeder Available for only \$ 39)

IBM

IBM 5152 Graphics \$ 129
narrow carriage, 80 cps excellent for graphics & labels widely supported by software

IBM 5181 Compact \$ 99
1200 Baud serial, very quiet thermal operation, Uses FAX Paper

IBM 5182 Color ³¹⁵⁹
wide carriage, heavy duty, 200 cps draft, 35 cps NLQ, COLOR or black & white good with Lotus Freelance & PC Paintbrush (auto switching 110 - 220 volt power) (orig cost \$ 1995)

IBM 4201 ProPrinter I \$ 159
narrow carriage, 180 cps

IBM ProPrinter XL \$ 249
wide carriage, 180 cps

IBM ProPrinter II \$ 239
narrow carriage, 240 cps, NLQ

IBM ProPrinter III \$ 399
narrow carriage, 320 cps draft, 65cps NLQ

IBM ProPrinter 3XL \$ 339
wide carriage, 320 cps draft, 65 cps NLQ

IBM ProPrinter XL24E \$ 469
wide carriage, 24 pin, 288cps draft, 96cps NLQ

IBM ProPrinter Serial Option Kit \$ 45
Changes Parallel Input to Serial Input

IBM Quietwriter I 4202-001 \$ 195

IBM Quietwriter II 4202-002 \$ 249
True Letter Quality, up to 60 cps, tractor & sheetfeeder available

IBM Quietwriter III \$ 389
Letter quality & very "Quiet" 274 cps draft, 171 cps LQ, tractor, sheet and envelope feeder available

IBM Solution Pack \$ 575

4202 with special software

IBM 5533 Industrial \$ 275
Narrow carriage with positive flow Air Filter system to keep printer clean in dirty environments.

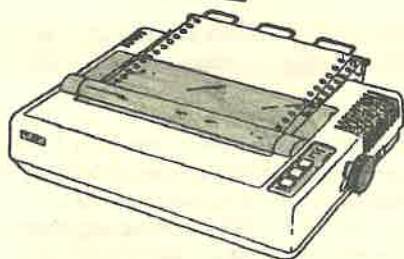
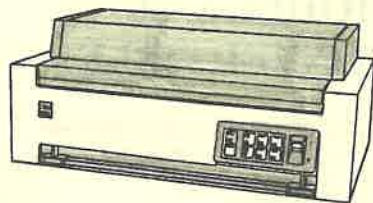

OKIDATA

Okidata 84/Parallel \$ 249
wide carriage, 220 cps

Okidata 182/IBM Parallel \$ 149
narrow carriage 180 cps

Okidata 182/IBM Serial \$ 199
narrow carriage 180 cps

Okidata 182 TURBO /IBM Parallel \$ 199
narrow carriage, 240 cps, NLQ, "NEW"

Okidata 193 \$ 195
wide carriage, 180 cps

Okidata 393 & 393/Plus \$ CALL

Okidata 2350/OKI Parallel \$ 479

Okidata 2350/IBM Parallel \$ 579

Okidata 2410/OKI Parallel \$ 479

Okidata 2410/IBM Parallel \$ 579
For Serial Option on either the Okidata 2350 or 2410 add \$ 90

wide carriage, very heavy duty, 420 cps draft, NLQ, will print 8 part carbon paper

Okidata 320 & 321 \$ CALL

Okidata 390 & 391 \$ CALL

Star Rainbow NEW \$ 199
9 pin, narrow carriage, prints in 7 colors, paper park feature, 144 cps draft, 34cps NLQ

Used, Demo and refurbished Printers

" TEMPEST SPY Proof "

ITC-T20 (Diablo 630) \$ 249
with 9 pin dot matrix print head

ITC-T30 (MPI 350) \$ 249

ITC-T50 (AMT 2030) \$ 389
Cold War Surplus - Printers extensive EMI Shielding

Ti 810 Basic \$ 269
wide carriage, heavy duty

Toshiba P351C \$ 479
wide carriage, 240 cps draft, NLQ, color option

Toshiba P351/SX \$ 569
wide carriage, 260 cps draft, NLQ,

built in fonts,

Toshiba P351/SX Optional Macintosh interface kit available \$ 39

Continued

TANDY LP-5 \$ 129
wide carriage for Tandy Computers

TANDY DMP-105 \$ 59
narrow carriage for Tandy Model 100 or IBM computers with software driver

TANDY DMP-400 \$ 159
wide carriage for Tandy Computers

MISCELLANEOUS BRANDS CALL

9 Pin, 18 Pin & 24 Pin - We allays have something that is not listed her so don't hesitate to call

LASER PRINTERS

HP Laser Series I \$ 449

HP Laser Series II \$ CALL

HP Laser Series IID \$ 1695

HP Laser Series III \$ CALL

HP Laser Printer Font Cartridges \$ 39
CALL for availability on the specific font cartridge you need

IBM 4216-020 \$ 999
NEW, Requires interface card for both the Computer & Printer and driver Software (Not Supplied)

Ti 2015 \$ 849
15 Page per Minute, 2 paper trays, Emulates HP Laser Jet, Diablo 630, Ti 855, & Ti 810

DAISYWHEEL True Letter Quality

Amdtek 3050 New \$ 299
17 cps, "Quantity Available"

Diablo 630 \$ 199
wide carriage, heavy duty, Parallel,

API, or Serial Input

(Sheetfeeders Available, See List or \$ CALL)

NEC 3550 \$ 249
wide carriage, 35 cps

TRS-80 DW-II \$ 199

TRS-80 DW-IIB \$ 239
wide carriage, 35 cps, heavy duty operation

(Sheetfeeders Available \$ 69)

SOUND HOOD New \$ 49
with fan, large enough to hold most wide carriage dot matrix & daisywheel printers with sheetfeeder (Large but not Heavy can not be shipped by UPS)

IBM 5218 Convenience Pack \$ 39
cable & software to use the IBM 5218-003

"Displaywriter Printer" on an IBM type Personal computer (will NOT work on the 001 or 002 models)

Note: Most wide carriage printers are heavy thus shipping by UPS or Federal Express necessitates adequate packing. We pack all printers for shipment in containers sufficient to withstand shipment. Oki 2410 & 2350 printers are too large to be shipped by UPS.

Note: Most wide carriage printers are heavy thus shipping by UPS or Federal Express necessitates adequate packing. We pack all printers for shipment in containers sufficient to withstand shipment. Oki 2410 & 2350 printers are too large to be shipped by UPS.

Note: Most wide carriage printers are heavy thus shipping by UPS or Federal Express necessitates adequate packing. We pack all printers for shipment in containers sufficient to withstand shipment. Oki 2410 & 2350 printers are too large to be shipped by UPS.

Note: Most wide carriage printers are heavy thus shipping by UPS or Federal Express necessitates adequate packing. We pack all printers for shipment in containers sufficient to withstand shipment. Oki 2410 & 2350 printers are too large to be shipped by UPS.

Note: Most wide carriage printers are heavy thus shipping by UPS or Federal Express necessitates adequate packing. We pack all printers for shipment in containers sufficient to withstand shipment. Oki 2410 & 2350 printers are too large to be shipped by UPS.

JUST ASK
Our stock of printers varies constantly. If you have a need contact us we may have what you are looking for even though it is not listed here.

[H]

[I]

TRACTORS AND SHEETFEEDERS

WIDE SELECTION - FOR POPULAR PRINTERS

Some for Old Models - Some for New Models - Priced Below Wholesale
If You do not see what you need - Call us we may have it or can get it

| | | |
|----------------------------------------------------------------------------------|--------|-----------------------------------------------------------------------------------------|
| ALPS | | OKIDATA |
| 2000 Single Bin Sheet Feeders | \$ 79 | Roll Paper Stand for ML 82 \$ 10 |
| | | Roll Paper Stand for ML 182 \$ 10 |
| BROTHER | | 230 Easy Feed Single Bin S/F for ML 93 \$ 79 |
| Sheetfeeder for the Brother or Comrex HR-15 | \$ 49 | CSF 1000 Sheetfeeder for ML292/293 \$ 175 |
| Tractor for Brother HR-15 | \$ 59 | CSF 3800 Sheetfeeder for ML 380 \$ 49 |
| | | CSF 3001 Sheetfeeder for ML 393 \$ 375 |
| C.ITOH | | Tractor for 100 Series \$ 39 |
| T-UDC Uni-Directional Tractor for C-815 | \$ 69 | Tractor for ML 321/391 \$ 59 |
| T-BDC Bi-Directional Tractor for C-815 | \$ 99 | Tractor for ML 393 \$ 59 |
| SAF552 Dual Bin Sheetfeeder for D10/F10 | \$ 249 | |
| CITIZEN | | PANASONIC |
| MSP 15 Single Bin Sheetfeeder | \$ 39 | 3131 Bi-Directional Tractor for KX-P21 \$ 39 |
| MSP 10/20 Single Bin S/F for Model 120D | \$ 39 | |
| M 316 Dual Bin S/F for Premier 35 | \$ 59 | QUME |
| | | SPRINT 3 Tractor (Used) \$ 59 |
| DATA PRODUCTS | | 840009-01 Bi-Directional Tractor \$ 39 |
| DP55 Tractor for DP-55 | \$ 59 | Power Supply for Qume Sprint 3 \$ 29 |
| DIABLO | | SEKOSHA |
| F32 Dual Bin Sheetfeeder for Diablo 630 | \$ 129 | BP-CSF Dual Bin sheetfeed for BP-5420 \$ 175 |
| F21 Dual Bin S/F for Diablo 620 | \$ 129 | Same as EPSON 4201 and Comrex 420 |
| EPSON | | SILVER REED |
| 7330 S/F | \$ 69 | CSF-131 Single Bin S/F for EXP 600/800 \$ 69 |
| Single-bin S/f for LQ-1500 | \$ 79 | |
| 7334 Single Bin Sheetfeeder | \$ 39 | STAR |
| 8300 Tractor for FX-80 | \$ 39 | Single Bin Sheetfeeder for SR-10/15 \$ 49 |
| 8333 Single Bin S/F for FX-100/100+ | \$ 39 | SF-10D Single Bin Sheetfeeder for SR-10 \$ 49 |
| 8338 Single Bin S/F for LX 80/90 | \$ 39 | |
| IBM | | TANDY |
| 1341091 Tractor for Quietwriter I or II | \$ 39 | 26-1477 Dual Bin Sheetfeeder for DW-510 \$ 99 |
| 6373100 Single Bin Sheet feeder for Quietwriter I or II (Used) | \$ 99 | 26- Single Bin Sheetfeeder for DW-II, II/B, Also Fits Rico 1300 & 1600 and others \$ 29 |
| 1479620 Envelope Feder for Quietwriter I or II | \$ 179 | 26- Unidirectional Tractor for DWP-410 \$ 29 |
| Single Bin Sheet Feeder for Quietwriter III | \$ 180 | |
| Dual Bin Sheet Feeder for Quietwriter III | \$ 245 | TOSHIBA |
| Envelope Option Feeder for Quietwriter III (Requires Either Sheet Feeder Option) | \$ 95 | TRF1555AZZ UniDi Tractor for P 351/341 \$ 169 |
| 799478 Paper Tray for Laser Printer | \$ 19 | MS25 Single Bin Demand S/F for P 351/341 \$ 225 |
| Single Bin S/F for Proprinter 1 | \$ 79 | MS15 Single Bin Sheetfeeder for P 321 \$ 199 |
| Single Bin S/F for XL 24 | \$ 129 | MD25 Second Bin Option for MS25 S/F \$ 99 |
| Paper Catch Rack for 5182 Color Printer | \$ 19 | Used on P351/341 Printer |
| | | ASF2556AZZO Electronic S/F for P351/341 \$ 249 |
| | | TRF2556AZZ Bi-Di Tractor for P351/341 \$ 179 |
| | | TRF1251AZZ01 Unidirectional Tractor for P321 \$ 79 |
| | | ME27 Dual Bin Sheetfeeder for P351SX \$ 329 |
| | | EXA1133ZAZZ Color Upgrade Kit for P351SX \$ 129 |

IBM MODEL 5140 PC CONVERTIBLE

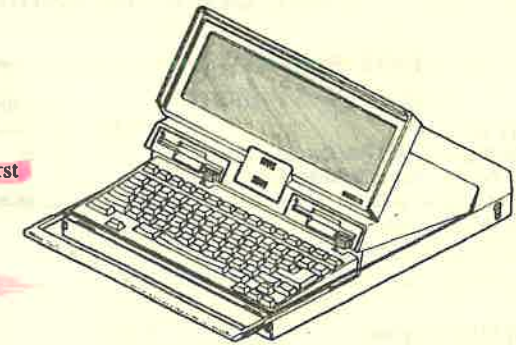

The technological laptop pioneer of the 1980's. First IBM laptop computer made with surface mount technology components.

The first computer made small enough to be comfortably carried by business people and students.

Features: 8088 processor, two 720K 3.5 floppy disk drives, LCD display screen, RAM memory of 256K to maximum of 640K, Internal Battery, AC adapter (110 volts or 220 volts). An optional attachable Printer mounts on to the computer and uses ribbons or thermal paper. An optional CRT Adapter provides outputs for CGA & Monochrome monitors or a TV. An optional Serial / Parallel Attachment provides one serial port and one parallel port.

Model 5140-002 **Used \$ 349**
512K RAM Memory - Enhanced LCD - Battery - AC adapter - Convertible Printer and Carrying Case. DOS is not included.

Model 5140-003 **New \$ 695**
256K RAM Memory - Backlit LCD - Battery - AC Adapter - New and in the original box. DOS is not included.

CONVERTIBLE LCD SCREENS

Standard LCD: \$ 20

The lowest quality LCD screen used on the model 5140 computer. The screen appears solid dark charcoal grey when contrast is turned to the maximum.

Enhanced LCD: \$ 79

The medium quality LCD screen used on the model 5140 computer. The screen appears solid bluish purple when the contrast is turned to the maximum. A supertwist LCD screen with a 5:1 dark to light ratio.

Backlit LCD: \$ CALL

The highest quality LCD screen for the 5140 computer. The screen has a bluish-silver light when in use and has two slide controls. Due to additional power needs an enhanced internal power supply is required for proper operation.

HOW TO ORDER

CALL: (214) 276-8072 Normal Business Hours - Central Time Zone
Monday - Saturday

FAX: (214) 272-7920 Anytime Any Day or Night
- Catalog Requests
- Order Forms for Orders to be Sent COD
- School & Government Purchase Orders

Payment: - Prepayment in U.S. Funds
- COD by United Parcel Service with Payment By Cash, Money Order or Certified Funds
- Electronic Transfer (call first for routing info)

- Personal & Other Checks are Held 10 Working Days Before Shipment of the Goods

- Payment by Cashiers Check, Money Order, Certified Funds or Electronic Transfer Will Assure Immediate Shipment

Shipment: - We ship by United Parcel Service, U.S. Post Office Federal Express, Air Freight, or common carrier at our choice. You must make special arrangements for a carrier of your choice.

WARRANTIES: Modem slot control card and cable - 1 YEAR
2nd Disk drive and power supply - 90 DAYS
Jr HOTSHOT control card and cable - 2 YEARS
Connecting Cables-ribbon or power - 1 year
(except for cable cuts due to mishandling)
Replacement disk Drives - 6 Months
IBM Brand Disk Drives - 6 Months
Racore Products (manufacturers) - 1 Year
Keyboards - 6 Months
Hard Drives Systems Drive Only - 1 Year
Supporting System - 90 Days
Repair Service & Parts
(when Service Performed in our Shop) 60 Days
Used & Demo Products 5 Day DOA
(repair or replace at our option)

Modems, Mice and Some Other Products We Sell are subject to their own Manufacturers Warranty this will vary upon that specific company and will be handled directly by that Manufacturer.

TRADEMARKS: IBM, PCjr, CONVERTIBLE, PC, PC/XT, PC/AT, Proprinter, Quietwriter are trademarks of I B M Corp., jr-Captain is a trademark of Tecmar Inc., Microsoft Booster is a trademark of Microsoft Corporation, MacIntosh is a trademark of Apple Computer Corp., MMODEL-100 is a trademark of TANDY CORP.

PCjr PARTS AND PORTS

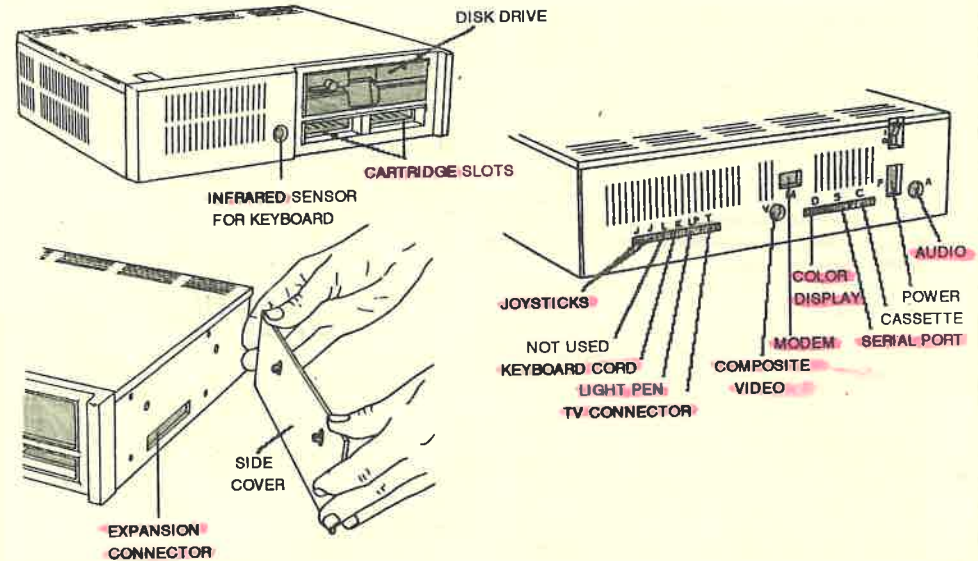

PC CONVERTIBLE PARTS AND PORTS

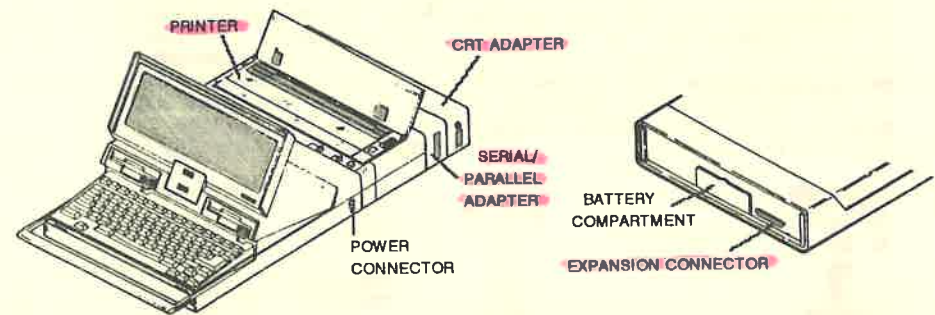

3

CALL (214) 276-8072
P.O. Box 401782

COMPUTER
RESET

FAX & BBS (214) 272-7020
Garland, Texas 75040-1782

3

2

2

HOW TO TELL IF YOU CAN USE THE NEC V-20 CHIP OR THE jrHOTSHOT

In order to use the NEC V-20 to replace the 8088 chip in your computer, the 8088 must be installed in a socket so that it can be removed. The same is true of the jrHotshot memory expansion. While most PCjr computers will have a socket, the last units to be produced by IBM did not, so you need to check your computer before ordering either of these products. **Of course, if your 8088 is soldered down, we can install a socket for you for \$45, plus return shipping (see pages 14-15).**

To check your PCjr, remove the top cover by snapping it loose from the case along the rear edge (if it is very tight, a flat-head screwdriver inserted in one of the three slots along the back will help pry it loose). Compare the inside of your PCjr with the diagram shown. You will need to locate the VIDEO ROM chip which is directly behind (and partially under) the INFRARED RECEIVER module. Look at this chip closely, and compare it to the drawing to the right. If it looks like it is sitting higher than the smaller chips around it, as shown, it is socketed. If it is sitting at the same height as the others, it is soldered and you will need to have a socket installed.

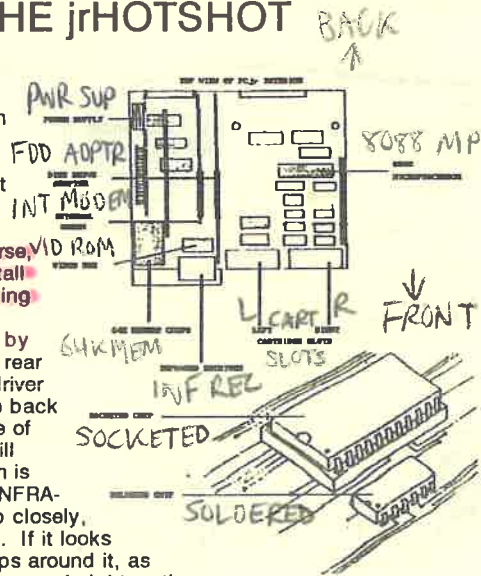

PCjr VIDEO ROM: NORMAL vs THIN FONT

The video ROM in the PCjr displays characters made up of tiny dots of light. If you look closely at the screen, you will see that the lines which make up the text characters are two dots thick (see illustration below). This is the normal way for the VIDEO ROM to work. The Thin Font ROM, however, changes this so that the lines which make up the text characters are only one dot wide, thus making them appear sharper. There are two versions of the Thin Font ROM available, one which has characters in a **Serif font**, similar to the normal characters, and a dual chip which can be switched to **Sans-Serif** for a clean, high-tech look.

Thin Font ROM Chip \$19

Dual Thin Font Rom Chip \$29

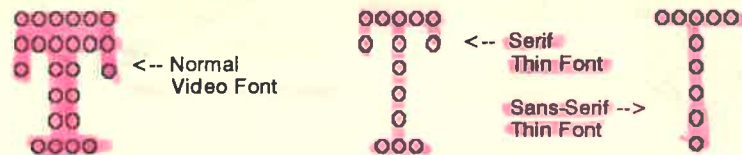

4

CALL (214) 276-8072
P.O. Box 401782

**COMPUTER
RESET**

FAX & BBS (214) 272-7020
Garland, Texas 75040 - 1782

4

jrHotshot MULTI-FUNCTION UPGRADES

256K OR 512K jrHOTSHOT FAST MEMORY PLUG-INS

Adds fast, contiguous memory at addresses 128K and above. Fast Memory increases the PCjr performance to the level of a PCXT as proven by the speed measurement program sent along on a diskette. If you have a 128K PCjr, the 512K plug-in gives you contiguous memory from 0-640K, or with the 256K upgrade you'll have contiguous memory from 0-384K. **No additional power supply is needed.**

Simple "device driver" software supplied with the upgrade should be copied once onto your DOS diskette so the Fast Memory is instantly recognized whenever you boot up your PCjr. The driver works elegantly and transparently. This software also gives your PCjr an 80-column screen immediately. It's easy, especially since everything is fully explained with illustrated directions.

2nd DRIVE CONTROLLER OPTION

You can have this useful Controller plug-in as an option to any jrHotshot Fast Memory. With this option a second floppy disk drive can be added to your PCjr. This board will control either a 5-1/4" 360K disk drive or a 3-1/2" 720K disk drive (DOS 3.2 or later is required for 720K drives). This option includes the signal cable which interfaces the existing drive to a second external drive, and software that allows DOS to recognize the second drive.

REAL-TIME CLOCK/CALENDAR OPTION

This is a super clock/calendar option to the jrHotshot Fast Memory. This option conveniently date and time stamps your files when saved, which makes them easier to identify later. Has the best clock chip possible that stays accurate even through leap years. A long-life lithium battery keeps the time accurate, even when the computer is off, and the battery holder has a clip that allows easy replacement. With the software provided, setting the time is simple, and the PCjr will automatically read the date and time when switched on.

Included with all jrHotshot Fast Memory plug-ins is a disk of Utility Programs, including an adjustable RAM disk program. This allows you to use some of the jrHotshot memory as if you had another drive.

- jrHotshot Fast Memory Board with no memory chips installed (you supply 8 or 16 256K chips) \$ 125
- jrHotshot Fast Memory Board with 256K of memory \$ 149
- jrHotshot Fast Memory Board with 512K of memory \$ 199
- jrHotshot Fast Memory with Second Disk Drive Controller and Cable Add \$35 to above prices
- jrHotshot Fast Memory with Real-Time Clock/Calendar Add \$35 to above prices
- jrHotshot Fast Memory with Second Drive Disk Controller, Cable, and Clock Add \$70 to above prices

5

CALL (214) 276-8072
P.O. Box 481782

**COMPUTER
RESET**

FAX & BBS (214) 272-7020
Garland, Texas 75048 - 1782

5

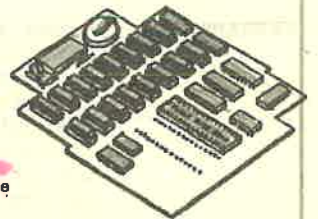
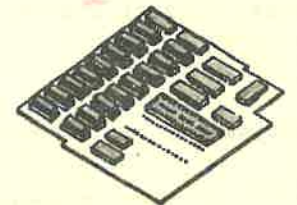

PCjr HARD DRIVES

These hard drives for the PCjr are available in 20 or 40 meg capacities. The drives are self-booting, unlike some which require a special cartridge or booting from a floppy disk. The controller interfaces to the PCjr through a special buss card slot adapter which connects to the expansion connector on the PCjr. The drive and controller are XT compatible, which means that you can use them in a PC-XT computer - just remove a jumper on the controller and install in a PC-XT or compatible computer! These drives are pre-formatted and come with everything you need to connect them to your Jr. PLEASE give us a description of your system when ordering so that we can set up the drive properly, as well as give you any other information that you may need to connect to your system.

NOTE: In order to use these hard drives with the Racore Drive II Plus with DMA, the DMA feature of your system will have to be disabled, which is not included! Also, some clock circuits in a few of the PCjr expansions will have to be disabled or changed.

20 MEG
\$399

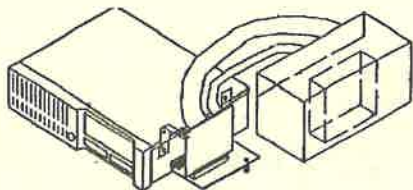

40 MEG
\$529

PCjr NETWORKING

There are three ways to connect a PCjr to a computer network. They are:

1. IBM Cluster Attachment connected to an IBM Cluster Network.
2. IBM Cluster Attachment connected to a Novell Network.
3. Synectics Enhanced Second Serial Port connected to Imodes \$ 25 Network.

We offer the IBM Cluster Attachment for \$95, and the Synectics Enhanced Second Serial Port for \$69.

We occasionally come across the software and other hardware needed for networking the PCjr. Call for availability and prices!

SECOND DRIVES FOR THE PCjr

An IBM PCjr can operate either the conventional 5-1/4" 360K disk drives or the newer 3-1/2" 720K disk drives (DOS 3.2 or later is required for the 720K drives; DOS not included).

MODEM SLOT DISK DRIVE CONTROL CARD This card plugs into the computer internal modem slot and connects to the existing disk drive control card by the cable originally used for the internal disk drive. This type drive controller is recommended for PCjrs where the internal modem slot is not being used by a modem. An external modem can then be used with the computer by attaching it with the IBM Adapter Cable for Serial Devices (sold separately).

JRHOTSHOT DISK DRIVE CONTROL CARD This auxiliary card fits below the existing disk drive and plugs into the 8088 microprocessor chip socket. The 8088 is in turn plugged into this card (the 8088 can be replaced with the NEC v-20 to speed up the PCjr's operation by about 20% for some operations). This type drive controller is recommended for PCjr computers where the internal modem slot is being used by a modem.

FEATURES OF SECOND DRIVE SYSTEMS:

- * 5-1/4" or 3-1/2" drive is mounted in a stand-alone cabinet. The 5-1/4" drive cabinet contains its own power supply; the 3-1/2" drive uses a power-sharing cable which draws power from the PCjr.
- * Connecting signal cable joins the auxiliary control card to the existing internal disk drive and to the new second drive. A slot in the PCjr case is used to pass this ribbon cable from the computer to the second disk drive.
- * Enabling software contains files to configure your DOS boot disk for recognition of the second drive.
- * Compatibility with all side-mounted memory products, such as those manufactured by IBM, AST, Tecmar, Quadram, Microsoft, and Impulsa.
- * If you have a Quadram, Rapport, or Racore Expansion Chassis which adds a second drive to your PCjr, we can replace one or both drives with a 3-1/2" drive. See our PCjr Service section for details!

MODEM SLOT SYSTEM

| | |
|-------------------------------------------------------------------------|--------|
| 5-1/4" 360K Second Disk Drive System (see description above) | \$ 179 |
| 3-1/2" 720K Second Disk Drive System (DOS 3.20 required - not included) | \$ 199 |
| Modem Slot Kit includes controller, cable, and software (no drive) | \$ 49 |

JRHOTSHOT SYSTEM

| | |
|-------------------------------------------------------------------------|--------|
| 5-1/4" 360K Second Disk Drive System (see description above) | \$ 234 |
| 3-1/2" 720K Second Disk Drive System (DOS 3.20 required - not included) | \$ 245 |
| JrHotshot Kit includes controller board, cable, and software (no drive) | \$ 79 |

DISK DRIVES WITH CABINET:

(No controller, signal cable, or enabling software)

| | |
|--------------------------------------------------------------------------------------------------|--------|
| For those who already own a second drive controller and cable, or for the "do-it-yourself" user. | |
| 3-1/2" 720K Drive mounted in a low-profile cabinet with power-sharing cable | \$ 165 |
| 5-1/4" 360K Drive mounted in a vertical-standing cabinet with power supply | \$ 155 |

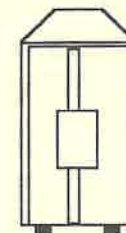

6

CALL (214) 270-8072
P.O. Box 481782

COMPUTER
RESET

FAX & BBS (214) 272-7020
Garland, Texas 75048-1782

6

7

CALL (214) 270-8072
P.O. Box 481782

COMPUTER
RESET

FAX & BBS (214) 272-7020
Garland, Texas 75048-1782

7

Genuine IBM Accessories for the PCjr

ADAPTER CABLE FOR SERIAL DEVICES

Converts Jr. serial port to a standard 25-pin RS-232 male connector. Allows use of a serial mouse or external modem with the PCjr. **\$ 20**



COLOR DISPLAY ADAPTER

Converts Jr. display port to a standard 9-pin D-shell connector. Allows use of IBM compatible CGA monitors with the PCjr. **\$ 15**



KEYBOARD CORD

Allows use of the Jr. keyboard without batteries. **\$ 15**

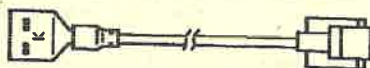

ADAPTER CABLE FOR CASSETTE

Used with a cassette tape recorder for storing BASIC programs. Can be converted to a joystick adapter (instructions included - soldering skills required!). **\$ 12**

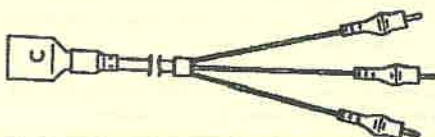

INTERNAL MODEM

The 300 baud modem made just for the Jr. includes Jr-Tele Shareware software to put you on-line. **\$ 29**

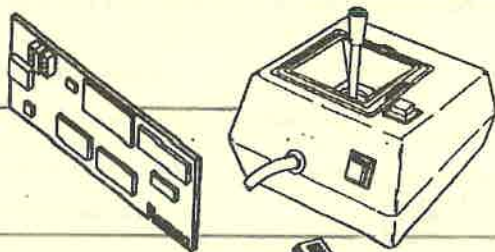

PCjr JOYSTICK

This game controller plugs directly into either one of the two joystick ports on the rear of the Jr. **\$ 29**

CONNECTOR FOR TV

RF modulator allows you to connect your Jr. to a television set. Those great Jr. graphics and sound both come through! **\$ 19**

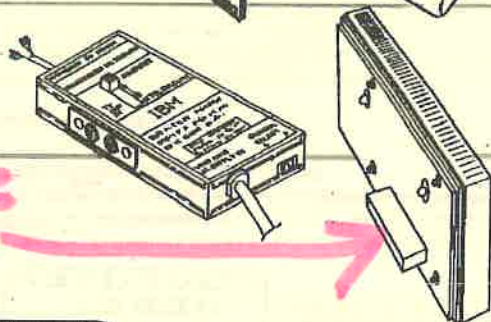

PARALLEL PRINTER ATTACHMENT

Sidecar allows you to attach any IBM-compatible parallel printer. Printer cable required, sold separately. **\$ 69**

SPEECH ATTACHMENT

Gives the PCjr the ability to speak with the proper software, such as the IBM Writing to Read series. Also digitize speech with a microphone (not included). Includes a demo program (Cartridge BASIC required) that can be adapted to your own BASIC programs. **\$ 109**

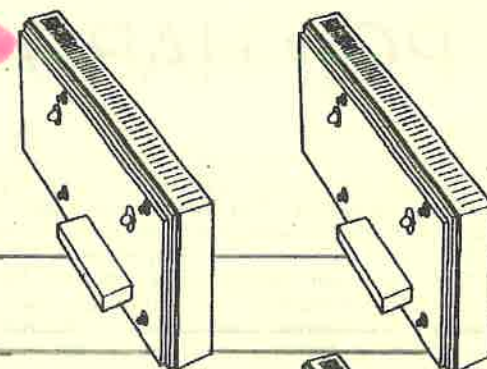

CLUSTER ATTACHMENT

Allows use of a PCjr computer in a network. **\$ 95**

128K MEMORY EXPANSION

Adds 128K of memory to PCjr; four of these can be combined to give the computer up to 640K. **\$ 175**

POWER EXPANSION ATTACHMENT

Provides additional power to the PCjr expansion bus. Required if you are using more than two sidecars. Package includes sidecar and power transformer. **\$ 55**

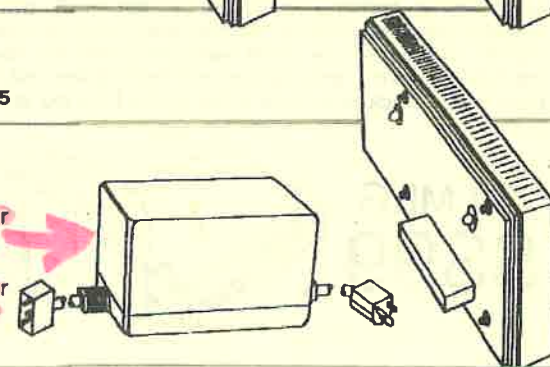

CARRYING CASE

Handy for transporting your PCjr computer. Has space for the CPU with up to 3 sidecars attached, the keyboard, power transformer, TV connector, and keyboard cord, as well as compartments for disks and cartridges. **\$ 29**

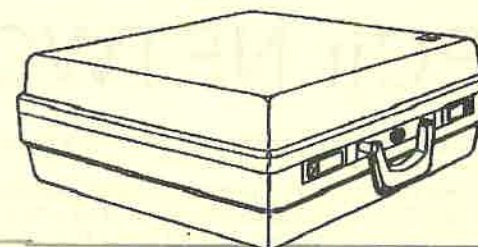

OTHER ACCESSORIES (not shown)

ENHANCED KEYBOARD **\$ 55**

CHICLET KEYBOARD **\$ 19**

CHICLET KEYBOARD OVERLAYS
Package of 5 **\$ 1**

POWER TRANSFORMER **\$ 45**

REAR PORT FRAMES Help prevent bent or broken pins! **\$ 8**

8

CALL (214) 276-8072
P.O. Box 481782

**COMPUTER
RESET**

FAX & BBS (214) 272-7920
Garland, Texas 75046 - 1782

8

9

CALL (214) 276-8072
P.O. Box 481782

**COMPUTER
RESET**

FAX & BBS (214) 272-7920
Garland, Texas 75046 - 1782

9

OTHER ACCESSORIES FOR PCjr

101 KEYBOARDS and ADAPTERS

These full-size keyboards are the Enhanced AT style similar to those used with the latest computers with Function Keys across the top, separate numeric and arrow key pads, and indicator lights for Caps Lock, NumLock, and Scroll Lock. If you like using a regular PCjr keyboard now, you'll LOVE using one of these! Prices include adapter for the PCjr. **\$ 134**

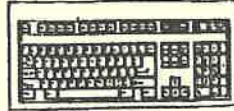

84/101 KEYBOARD ADAPTERS

Allows you to use 84 or 101 keyboards with the PCjr. The Racore adapter is external and plugs into the K and LP ports. It can use several of the major brands of keyboards, such as Chicony, Mitsumi, and Keytronics. The Synectics adapter is internal, replacing the Infrared Module inside the PCjr. It can use a wider range of keyboards, and includes a keystroke buffer that gives "type-ahead" capability even when the disk drive is reading or writing. **NOTE:** the 84 or 101 keyboards used with either adapter must be XT switchable. AT-only keyboards will NOT work! **RACORE or SYNECTICS ADAPTER \$ 49**

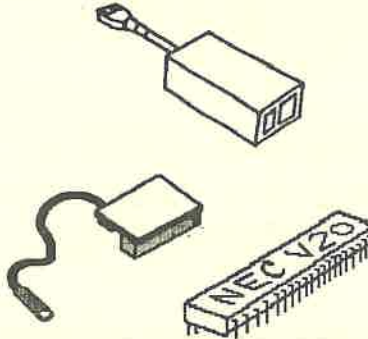

NEC V-20 MICROPROCESSOR Replaces the 8088 chip in your PCjr. The V-20's improved design processes data about 20% faster, giving your PCjr's speed a boost, and it draws less power from the power supply. Recommended for the jrHotshot memory upgrades. **NOTE:** most PCjr's have the 8088 in a socket, which makes it easily removeable. However, some will have this chip soldered directly to the motherboard. See our "How-To-Tell" section to examine your PCjr. V-20 includes instruction sheet and speed test diskette. **\$ 20**

PCjr MONITOR ADAPTER Allows you to use the PCjr Color Display with other computers having an IBM CGA card or equivalent. **\$ 49**

TECMAR JrSECOND MATE Has a parallel printer port and clock/calendar with replaceable battery. Includes software disk. **\$ 99**

SIAMESE SLOTS Cartridge adapter allows you to plug two cartridges into one slot - great if you have the cartridge version of Lotus 123 or Electric Desk. **\$ 30**

QUICKSILVER CARTRIDGE Gives a really fast bootup to your PCjr, especially if you have 640K memory! Also corrects some keyboard BIOS problems. **\$ 29**

CARTRIDGE CLOCK

Gives your PCjr the convenience of a battery-backed clock/calendar. Includes software for setting the time and date in the cartridge, as well as in DOS when you boot your computer. **\$ 34**

KEYTRONICS NUMERIC KEYPAD

Adds the convenience of a separate numeric keypad to the PCjr keyboard. Requires the the PCjr Keyboard Cord (not included). **\$ 39**

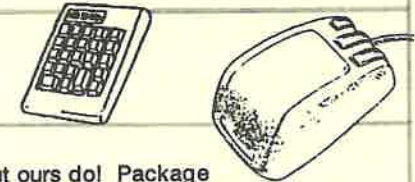

SERIAL MOUSE PACKAGE

Not all mouse packages work with the PCjr, but ours do! Package includes the mouse with enabling software, and Dr. Halo III graphics software (actual style may differ from illustration - Serial Adapter included). **\$ 79**

MOUSE PACKAGE WITHOUT SERIAL ADAPTER

MOUSE only -

\$ 59
~~\$ 39~~

300/1200/2400 BAUD EXTERNAL MODEM

This Hayes-compatible modem plugs into the Jr. Serial Port. Package includes Serial Adapter to connect it to your PCjr, as well as Telix or QModem-Jr Shareware software - please state memory size of computer when ordering! **\$ 149**
EXTERNAL MODEM ONLY - Serial Adapter and software not included \$ 129

SINGLE FONT VIDEO ROM CHIP

Makes text characters appear sharper on your screen by replacing the original character ROM chip. Does not affect graphics. Has serified characters similar to the original, but made up of finer lines. **\$ 19**

DUAL FONT VIDEO ROM CHIP

Like the above, but has a jumper to select an alternate non-serified font. **\$ 29**

SYNECTICS SECOND SERIAL PORT

Installs in the Internal Modem Slot inside the PCjr, providing a second serial port for a mouse or modem. Includes standard 25-pin male connector. **\$ 49**

MONITOR TILT AND SWIVEL STAND

Allows you to adjust the angle of the PCjr monitor for more comfortable viewing. Tilts up and down, and swivels side to side, and locks into place. **\$ 19**

PROTOTYPE EXPANSION BOARD

For the experimenter or designer - includes perforated PC board with tinned copper on one side and PCjr buss connector (enclosure not included) **\$ 45**

SURGE PROTECTOR

Your first line of defense against power surges! Six outlets with an on/off switch allows you to turn your entire system on and off with a flip of the switch. **\$ 15**

PARALLEL PRINTER CABLES

Attaches an IBM-compatible parallel printer to the PCjr Parallel Printer Attachment. Available in the following lengths: 6' - **\$ 19** 10' - **\$ 21** 12' - **\$ 23**

10

CALL (214) 270-8072
P.O. Box 481782

COMPUTER
RESET

FAX & BBS (214) 272-7020
Garland, Texas 75048 - 1782

10

11

CALL (214) 270-8072
P.O. Box 481782

COMPUTER
RESET

FAX & BBS (214) 272-7020
Garland, Texas 75048 - 1782

11

PC COMPACT PRINTER ADAPTER

Allows using the PCjr thermal printer with a standard 25-pin serial port. \$ 19

NULL MODEM ADAPTER

Sometimes needed when connecting a Serial printer to the PCjr. \$ 6

GENDER CHANGERS

25-pin adapters for gender problems. Specify Male/Male or Female/Female. \$ 6

SWITCH BOXES

Allows connecting more than one device to a computer port, or more than one computer to one device. Available in the following configurations:

2 Position Serial/Parallel - Switches all 25 lines. DB25 female connectors. \$ 25**2 Position Parallel** - Switches all 36 lines. 36 pin Centronics connectors. \$ 30**2 Position X Switch** - Aa/Bb to Ab/Ba cross switches two computers and printers. Specify DB25 or 36 pin Centronics connectors. \$ 39**4 Position Serial/Parallel** - Switches all 25 lines. DB25 female connectors. \$ 55**4 Position Parallel** - Switches all 36 lines. 36 pin Centronics connectors. \$ 49**SERIAL EXTENSION CABLES**

For connecting external devices to the PCjr Serial Adapter or to a Switch Box. To connect the Serial Adapter to a Switch Box, use a Male/Female cable; to connect a modem or mouse to a Switch Box, use a Male/Male.

5' MALE/MALE - Lines 1 - 8 and 20 connected. \$ 19**5' MALE/FEMALE** - Lines 1 - 8 and 20 connected. \$ 19**6' MALE/MALE** - All 25 lines connected. \$ 19

We are always anxious to learn about, promote, and acquire:

- NEW PCjr AND CONVERTIBLE PRODUCTS
- NEW USES FOR THESE COMPUTERS
- IDEAS AND DESIGNS FOR NEW PRODUCTS
- NEW SOFTWARE

Call, write, or FAX to the attention of the **Resource Development Manager**.

12

CALL (214) 278-8072
P.O. Box 401782**COMPUTER
RESET**FAX & BBS (214) 272-7920
Garland, Texas 75040 - 1782

12

BARGIAN PAGE

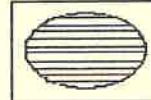
This is our Collection of Clearance Stuff
Limited Quantities - Closeouts - Got to Be Good for Something**AUTO BLASTER**

\$ 10

Amazing Little Box 3"x3"x1 1/2" Makes
Noises Like a High Performance Car -
Starting - Accelerating and Horn Honk
Requires a 9 volt battery**KIDS LOVE IT !!**Can be modified for use as an amplified
Speaker for use with a small radio
Soldering Required - Instructions Incl.**IBM 512K to 2 Meg Memory
Expansion**for the IBM AT,
Expanded Memory, IBM PN: 6450343

\$ 125 with 512K

10 NET Network Software

Simple Pier to Pier Network

Software Only \$ 49

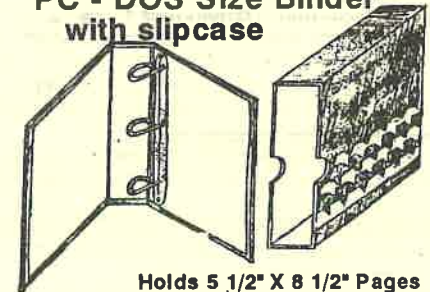
IBM Communication MgrA Perfectly Useless Program for todays
Modems - BUT It's Brand New sealed
package Includes 1 Disk, Binder & Slipcase**"Bargian" Only \$ 3****IBM Voice/Phone Assistant**Another Perfectly Useless Program in
Todays Market - BUT it's Brand New
Includes 1 Disk, Binder and Slipcase**"Bargian" Only \$ 3****IBM PC/AT Case Bottom****"Chassis"** An original IBM Part - NEW
in the BOX - No Top, No Keylock,
Unusual Find Only \$ 10**Commodore 64 & Vic-20****Parallel Printer Interface** for the C-64,
C-128 Computers to operate Epson
compatible printers \$ 29**IEEE Expansion for VIC -20**Used to operate many IEEE Interface
devices printers Etc. \$ 10**VEX-6 VIC - 20 Six Slot Expander** for
connecting Multiple Cartridges \$ 10**Pistol Grip Joystick- Set of two** \$ 10**MOBILE ATTACK** game for VIC -20 \$ 2**MAGNETIC TAPE****USED HI Grade MEMOREX GEO-XL**
2900' Roll Cheap \$ 2 roll
Good for Audio or Computer uses**PC - DOS Size Binder
with slipcase**

Holds 5 1/2" X 8 1/2" Pages

1 1/8" Ring Size \$ 2.49 Each
\$ 2 Each In case lot of 281 3/4" Ring Size \$ 3.25 Each
\$ 2.49 Each In Case of 20

13

13

PCjr Service and Parts

The prices listed below are for the exchange of parts in original and unserviced condition. Serviced or modified parts are subject to an additional 40% charge. Parts shipped in advance of receipt of bad parts require a 60% core charge to be refunded provided bad parts are received within 30 days.

| | |
|---------------------------------------------|---------|
| External Power Transformer * | \$45 |
| Internal Power Supply Card | \$ 69 |
| 64K Memory and Video Card | \$ 69 |
| Infrared Keyboard Receiver | \$ 55 |
| Enhanced PCjr Keyboard * | \$ 55 |
| Chiclet PCjr Keyboard * | \$ 19 |
| PCjr Keyboard Repair Kit * | \$ 25 |
| PCjr Fan * | \$ 19 |
| Disk Drive Controller Card | \$ 79 |
| IBM PCjr Replacement Drive * | \$125 |
| Non-IBM Replacement Drive * | \$ 96 |
| (above subject to availability) | |
| PCjr Logic Board * | \$199 |
| PCjr Logic Board | \$ 95 |
| 8088 Processor Chip * | \$ 10 |
| Mouse Systems PCjr Mouse Replacement Cord * | \$ 15 |
| Tecmar jrCaptain Transformer * | \$ 19 |
| Tecmar jr Captain Battery * | \$ 8.50 |
| Microsoft Booster Battery * | \$10.50 |
| jrHotshot or Racore Battery * | \$ 4.50 |

* No exchange needed on this part

If your 8088 processor is soldered down, we can install a socket for you for \$45. This will allow you to use a NEC-V20 or jrHotshot!

MEMORY EXPANSION SERVICE

We can expand the memory capacity of a 128K side-mounted memory expansion to 512K, giving your system a total of 640K. Allow 15 working days after we receive your unit.

| | |
|-------------------------|--------|
| IBM or TECMAR jrCAPTAIN | \$ 199 |
| MICROSOFT jrBOOSTER | \$ 225 |

Our prices include memory chips, sockets, and labor.

If you own more than one 128K sidecar, you can trade in your working sidecar for a \$35 credit.

TANDY MODIFICATION

Allows you to run some software in 16 colors that ordinarily would be in only 4 color CGA on the PCjr, such as Battle Chess and Zany Golf. Our price includes parts and labor (return shipping not included). \$ 39

PCjr COMPUTERS & MONITORS

NEW PCjr Computer with 128K, keyboard, and disk drive in original box. \$ 299

USED PCjr Computer with 128K, keyboard, disk drive. ~~\$ 299~~ ¹⁶⁹

USED PCjr Color Display ~~\$ 100~~ ¹⁶⁹

Do you have a Quadram, Rapport, or Racore Expansion? We haven't forgotten you! Turn the page!

RACORE / QUADRAM EXPANSION SERVICE AND PARTS

| | |
|--------------------------------------------------|-------|
| Internal Power Supply Repair | \$ 69 |
| Side Panel Repair | \$ 75 |
| DMA Drive Controller Repair | \$ 75 |
| Replacement Drive Cable for using a 3-1/2" drive | \$ 24 |
| Replacement 720K 3-1/2" Drive | \$ 96 |
| Cooling fan - Model 1500-1501 | \$ 19 |
| Setup software (specify model) | \$ 10 |

PCjr SERVICE PRICES

| | |
|----------------------------------------------------------------------------------------------------------------------------------------------------------------------------------|----------|
| Logic Board - Broken Pin Repair | \$ 45 |
| Logic Board - Fault Repair | \$ 95 |
| Logic Board - 8088 Socket Installation | \$ 45 |
| Logic Board - Tandy 16-color modification | \$ 39 |
| Disk Drive - Clean & Align | \$ 55 |
| (Most PCjr disk drives can be repaired, but some have broken or shorted read/write heads and are non-repairable. If a disk drive is not repairable, there is no service charge.) | |
| PCjr Monitor - Minor Repair | \$ 45 |
| Typical symptoms: - no green light above switch - scrambled lines, not readable - constant vertical roll. | |
| PCjr Monitor - Major Repair | \$ 45 |
| Typical symptoms: - squealing noise at power up - vertical white line on screen - horizontal white line on screen - droppped; parts rattle inside. | to \$129 |

We can service many of the sidecar expansions, such as those made by Tecmar and Microsoft!

SERVICE PROCEDURE

Bring or ship your computer to us with a complete description of the problem or the work you would like done. Typical turn-around time is two days to two weeks, depending on the repairs needed and our current work load.

We know the continued good health of your PCjr is important, so our technicians will use their years of experience and knowledge to repair it efficiently and expediently.

When equipment is shipped to us for repair, we determine the nature of the problem shortly after receipt and notify the customer of the cost of repairs by mail, FAX, or telephone for authorization to proceed.

SERVICE CHARGES

| | |
|------------------------------------------------------------------------------------------------|-------|
| Minimum Service Charge | \$ 45 |
| Hourly Labor Rate | \$ 60 |
| Parts Costs - see previous pages | |
| Return Shipping - varies, depending upon equipment sent. Costs are quoted with repair charges. | |
| Repairs left over 60 days may be sold for the cost of repair charges against the articles. | |

What if you send something, and decide you don't want it fixed? No problem! We charge a \$ 25 diagnostics fee if you decide to not have the repairs done, plus return shipping. Just let us know when we contact you with a repair quote that you do not want the repair done, and send the fee, plus shipping.

IBM Convertible Model 5140

- 128K MEMORY CARD** \$ 79
- 256K MEMORY CARD** \$225
- 384K MEMORY CARD (by STB)** \$295

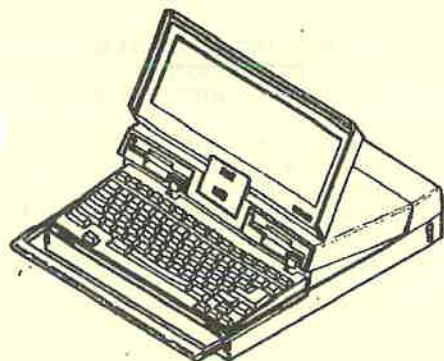

NOTE: The Convertible normally has space for four memory cards. If you have 256K of RAM, you have two spaces filled. If you wish to get the maximum memory of 640K, you would need one each of the 128K and 256K cards, or if you have the Backlit LCD on your Convertible, you can use the 384K card made by STB Systems.

SERIAL-PARALLEL ADAPTER

Adds one Serial Port for using a mouse or external modem, and one Parallel Port for using an IBM-compatible printer. \$120

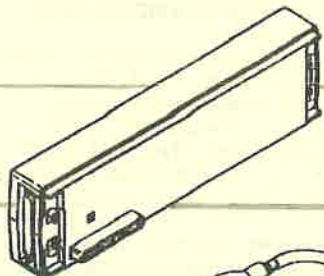

CRT ADAPTER

Allows connecting the Convertible Mono or CGA monitor, or the TV Connector. \$ 99

ADAPTER CABLE FOR COLOR DISPLAY
Allows connecting an IBM-compatible CGA monitor with 9-pin connector to the CRT Adapter above. \$ 15

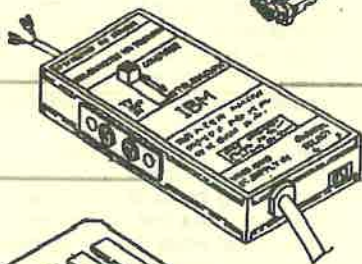

CONNECTOR FOR TV

Allows connecting a television to the CRT Adapter above. \$ 19

IBM INTERNAL MODEM

The original 1200 baud non-Hayes compatible modem. Includes the Shareware version of Procomm software set up for this modem. ~~\$ 59~~ 29

IBM ENHANCED INTERNAL MODEM
Adds a 1200 baud Hayes compatible modem to the Convertible. \$ 69

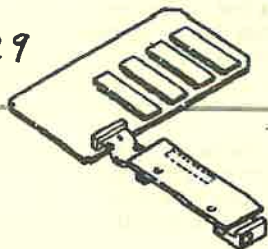

CONVERTIBLE PRINTER \$ 59
Attachable printer uses thermal-transfer technology to print with a ribbon, or can print without a ribbon on thermal paper. Prints up to 40 characters per second with a 24 element print head. Comes complete with roll-paper holder and one ribbon.

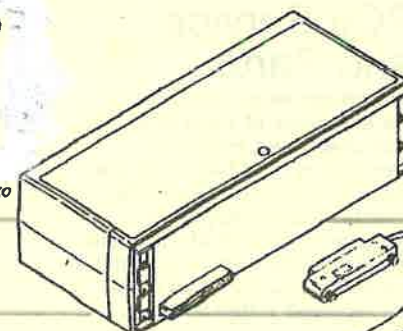

REPLACEMENT RIBBON

Allows printer to be placed to one side instead of being attached to the rear. \$ 15

CONVERTIBLE COLOR DISPLAY

13-inch CGA color monitor. Requires the CRT Adapter. \$ 109

CONVERTIBLE MONOCHROME DISPLAY

9-inch composite monochrome monitor. Requires the CRT Adapter. \$ 59

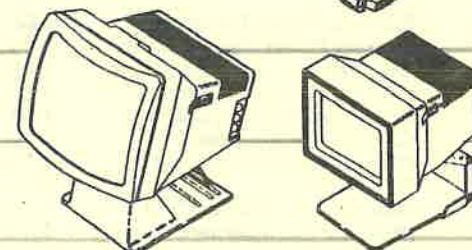

AUTOMOBILE POWER ADAPTER

Allows plugging the Convertible into a 12 volt cigarette lighter. CALL

AC POWER ADAPTER

Allows plugging the Convertible into a 110 volt AC outlet. \$ 75

BATTERY CHARGER

Charges the battery - saves wear and tear on your AC Adapter. \$ 23

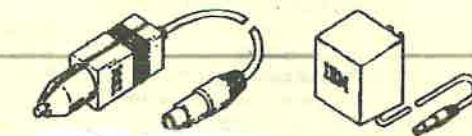

REPLACEMENT BATTERY PACK

Non-IBM replacement battery pack. \$ 89

IBM COMPACT CARRYING CASE

Has room for the Convertible inside, with a side pocket for accessories. \$ 39

IBM LARGE CARRYING CASE

Allows carrying the Convertible with the printer attached, and accessories. \$ 69

LTI CARRYING CASE

A "generic" carrying case for laptops, including the Convertible. \$ 49

**TECHNICAL REFERENCE or
HARDWARE MAINTENANCE
& SERVICE MANUAL**
Very limited quantity! \$ 69 each

**GENUINE IBM REPLACEMENT
PARTS AVAILABLE!**

We have many of the replacement parts for the Convertible, such as **Disk Drives** for \$155, and replacement case parts, too!

Call for availability!

16

CALL (214) 276-8072

**COMPUTER
RESET**

FAX & BBS (214) 272-7020

16

P.O. Box 481782

Garland, Texas 75046 - 1782

17

CALL (214) 276-8072

**COMPUTER
RESET**

FAX & BBS (214) 272-7020

17

P.O. Box 481782

Garland, Texas 75046 - 1782

IBM PC and PCjr SOFTWARE

PRICES ARE LOWER THAN EVER and QUANTITIES ARE LIMITED!
Don't delay! Orders are filled on a first-come, first-served basis!

IMPORTANT: PCjr memory size is critical! Many titles will run on a 128K PCjr, but software marked as follows have special considerations:

- * Requires 256K for PCjr
- ** Requires 384K or more for PCjr
- *** May not work on PCjr
- C Cartridge software for PCjr only

GAME SOFTWARE

MOUSER (C) Help the farmer rid his house of mice in this fast-action maze game. Ages 8 to adult.
6024087 (Joysticks optional) List \$ 27 NOW \$ 12

MINE SHAFT (C) Collect gems while avoiding the robot miners in this action game. Ages 10 to adult.
6024092 (Joysticks optional) List \$ 27 NOW \$ 12

KING'S QUEST I Guide Sir Graham in search of treasures to restore the kingdom. Ages 10 to adult.
6024093 (Joysticks optional) List \$ 59 NOW \$ 19

ZYLL A text-only, role-playing adventure game in the realm of the evil sorcerer ZYLL. Ages 12 to adult.
6024173 List \$ 29 NOW \$ 12

TRIVIA 101 Test your knowledge of the trivial. Play alone or against another player. Ages 16 to adult.
6024290 List \$ 27 NOW \$ 12

TV AND CINEMA 101 Test your TV and movie trivia knowledge, from Talkies to Trekkies!
6024291 List \$ 27 NOW \$ 12

TOUCHDOWN FOOTBALL Excellent sound and graphics for 1 or 2 players. Ages 12 & up. 6024295
(Need Joysticks) List \$39 NOW \$12

PC POOL CHALLENGES Realistic pool game with many optional settings. Ages 12 to adult.
6024296 List \$ 39 NOW \$ 12

SHAMUS You are a 21st century detective in search of the Shadow. Ages 12 to adult.
6024303 List \$ 29 NOW \$ 12

PERSONAL FINANCE

HOME BUDGET JR. Set up and maintain a household budget, and print reports.
6024130 (Need Cart. Basic) List \$45 NOW \$19

MANAGING YOUR MONEY 1.0 (C) Andrew Tobias' personal finance program for the PCjr.
6024301 List \$ 229 NOW \$ 19

HOME ASSISTANT SOLUTIONS An overlay for IBM Filing Assistant to customize it for the home budget
6024 NOW \$ 9

SPREADSHEET

LOTUS 123 Version 1A (C) The hard-to-find cartridge version for the 128K (or more) PCjr!
6187305 List \$ 495 NOW \$ 99

(more spreadsheet program on the next page)

LOTUS 123 2.0 UPGRADE ** Not just an upgrade, includes disks & full manuals.
0090050 NOW \$129

LOTUS 123 2.01 UPGRADE ** Disks and manual supplement upgrades version 2 to 2.01.
0090051 NOW \$ 49

LOTUS 123 INSTALLATION KIT Allows PCjr to display graphs in the disk version of Lotus 1A.
5020004 (Needs ver. 1A) WAS \$ 99 NOW \$ 12

UPGRADE NOTE: Owners of earlier versions of Lotus can upgrade to current versions of Lotus and Quattro Pro at reduced prices. Check with the publishers of these programs for details!

NUMBER WORKS/EXECUTIVE WRITER * Word processing and spreadsheet for PCjr.
5020005 (Tecmar expansion required) \$ 29

SUPERCALC 3 Spreadsheet with graph and data management included for PCjr.
6187170 WAS \$ 195 NOW \$ 29

VISICALC The original spreadsheet which inspired the development of Lotus - a classic!
6024004 NOW \$ 29

WORD PROCESSING

HOMeward A simple, easy to use word processor with a picture-based (icon) menu.
6024071 (For PCjr only) WAS \$ 89 NOW \$ 39

SAMNA WORD III *** A professional word processor for the serious business user. Not for use on IBM PCjr - Requires 512K RAM
6086002 WAS \$ 359 NOW \$ 39

Note:

The IBM DISPLAYWRITE series of software is designed similar to the Displaywrite dedicated word processors to make the transition to the computer easier.

DISPLAYWRITE I Original version even runs on a 128K PCjr - includes keyboard overlays.
6024188 \$ 39

DISPLAYWRITE 2 * Adds larger document capacity, ASCII file importing, and spell checker.
6024189 \$ 49

DISPLAYWRITE 2 Version 1.10 * Upgraded version to the above. Requires IBM 5140 PC Convertible
6024845 \$ 69

DISPLAYWRITE 3 * Advanced word processing with optional legal/ medical support (5.25").
6024845 (Requires 2 floppy disk drives) \$ 79
6489766 (Ver. 1.10 - 3.5" disk format) \$ 79

DISPLAYWRITE 4/2*** The version for the Popular IBM OS/2 operating system. Has enhanced data merging.
75X1121 \$ 225

DISPLAYWRITE ASSISTANT * Special version integrates with the IBM Assistant Series.
59X9958 (Requires 2 floppy disk drives) \$ 49

ELECTRIC DESK JR. (C) Word processing, database, spreadsheet, & communications.
6187243 WAS \$ 295 NOW \$ 59

ELECTRIC DESK XT ** Disk version of the above. Both can be upgraded to Lotus Works.
6187242 WAS \$ 325 NOW \$ 59

WORDPROOF A spelling checker for programs like Displaywrite 1 and others with ASCII output.
6024071 \$ 10

MAILMERGE * Allows creation of form letters with Wordstar version 1 (not for PCjr version!).
5020003 WAS \$ 179 NOW \$ 39

SPELLSTAR * Spelling checker for Wordstar version 1 (not for PCjr version!).
5020004 WAS \$ 179 NOW \$ 39

WORDSTAR, SPELL STAR, DATASTAR ETC. for CP/M 2.2 available See our TANDY Liquidation list Section of This Catalog.

BUSINESS

IBM PROJECT ASSISTANT * Keep track of projects & display them as Gantt charts.
6024462 WAS \$ 149 NOW \$ 49

18

18

19

19

IBM FILING ASSISTANT Set up records, then use powerful search functions to retrieve them.
6024145 WAS \$ 149 NOW \$ 39

IBM FILING ASSISTANT 2.0 * Upgrade to the above, but includes both 3.5" and 5.25" disks.
6024457 WAS \$ 149 NOW \$ 79

IBM GRAPHING ASSISTANT Create assorted types of graphs from Filing Assistant data.
6024147 WAS \$ 149 NOW \$ 49

IBM GRAPHING ASSISTANT 2.0 * Upgrade to the above includes 3.5" and 5.25" disks.
6024458 WAS \$ 149 NOW \$ 69

IBM PLANNING ASSISTANT Spreadsheet title in the Assistant Series (256K+ recommended).
6024148 WAS \$ 149 NOW \$ 29

IBM PLANNING ASSISTANT 2.0 * Upgrade to the above includes 3.5" and 5.25" disks.
62X0291 WAS \$ 149 NOW \$ 79

IBM PLANS + EDITION *** Financial modeling & decision support - requires Data Edition prog.
6410972 (2 floppies or hard drive) NOW \$ 59

IBM PLANS + EDITION 2.0 *** Upgrade to the above - requires Data Edition version 2.0
6476082 (2 floppies or hard drive) NOW \$ 79

IBM GRAPHS EDITION *** Produces assorted types of graphs from Data Edition program.
6410938 (2 floppies or hard drive) NOW \$ 59

IBM REPORTS + EDITION *** Custom report writer, screen designer, & application builder.
6410937 (Requires Data Edition) NOW \$ 59

IBM REPORTS + EDITION 2.0 *** Upgrade to the above - requires Data Edition version 2.0
6476061 (2 floppies or hard drive) NOW \$ 79

IBM DATA EDITION *** Information management system - the Personal Decision foundation
6410938 (2 floppies or hard drive) NOW \$ 59

IBM DATA EDITION 2.0 *** Upgrade to the above, except on 3.5" disks.
6478085 (2 floppies or hard drive) NOW \$ 79

IBM PAYROLL EDITION *** Simplifies the payroll process; interfaces with General Ledger Ed.
6410953 (Requires 256K & hard drive) \$ 59

IBM ENGLISH ACCESS EDITION *** Allows access to Decision Series using English phrases
6478065 (Requires Data Edition) NOW \$ 59

DIAGRAM MASTER by Decision Resources ** Create presentation-quality charts and diagrams.
6187158 NOW \$ 79

GRAPHICS SOFTWARE

PCjr COLORPAINT (C) Full-featured drawing program just for PCjr. Print your creations, too.
6024299 (Mouse req'd) WAS \$ 99 NOW \$ 19

ANIMATION CREATION Create pictures using the extended ASCII set, even make them move!
6024082 WAS \$ 35 NOW \$ 19

IBM DRAWING ASSISTANT * Allows you to create drawings for import to Drawing Assistant.
6024089 WAS \$ 149 NOW \$ 49

(NOTE: The following 3 titles require one of the following: IBM BASIC Compiler, IBM Fortran Compiler, or IBM Lattice C Compiler)

IBM GRAPHICS KERNAL SYSTEM *** High-function programming tool based on ISO/ANSI industry standards. 6024203 NOW \$ 129

IBM GRAPHICAL FILE SYSTEM *** Store and retrieve graphic files in a standard format.
6024205 NOW \$ 129

IBM GRAPHICS DEVELOPMENT TOOL KIT Write graphics software independent of the system on which it is written. 6024198 \$ 89

IBM PC STORYBOARD * Prepare color presentations with special effects and animation.
6318998 NOW \$ 69

IBM PC STORYBOARD PLUS *** Upgrade
6024401 NOW \$ 179

IBM PICTURE PAK - HOLIDAYS Library of images and animation for use with Storyboard.
6187323 NOW \$ 39

IBM PICTURE PAK - EYE OPENERS Library of images and animation for use with Storyboard.
6181340 NOW \$ 39

IBM SLIDE WRITE Create presentation-quality text charts on paper or for transparencies.
6317034 NOW \$ 39

BOOKS AND MANUALS

Jr GUIDE TO OPERATIONS/HANDS ON BASIC Just like the ones originally supplied with PCjr.
1502292 NOW \$ 25

IBM PC/XT GUIDE TO OPERATIONS For the original IBM PC/XT (8-slot computer).
6936810 NOW \$ 15

IBM PC/AT GUIDE TO OPERATIONS For the original IBM PC/AT (8 slot 286 computer).
6322511 or 1502241 or 6280068 NOW \$ 25

IBM PC/AT SYSTEM DOCUMENTATION With Guide to Operations, BASIC, & Setup manual, and Power Cord
6276837 or 6450201 NOW \$ 39

IBM PC/AT INSTALLATION & SETUP The guide to assembly, setup, and diagnostics.
1502491 (Includes setup disk) NOW \$ 29

IBM PC/AT TECHNICAL REFERENCE Technical information, schematics, & BIOS calls for the IBM 5170 PC/AT Computer
6260066 NOW \$ 59

IBM BASIC FOR THE PC Reference book for the BASIC language. An excellent Book for the BASIC programmer of any computer.
6025010 NOW \$ 10

TECMAR PC PAINTBRUSH Manual for a very early version of PC Paintbrush.
NOW \$ 7

UNDERSTANDING CP/M a how to use it book for the CP/M operatins system used on many Pre MS-DOS type computers
NOW \$ 9

IBM 3270 PC & PC/AT BOOKS

IBM 3270 GUIDE TO OPERATIONS Includes test plugs, BASIC supplement, & tutorial disk.
1837432 NOW \$ 15

IBM 3270 ONLINE TUTORIAL "How-to-use-it" book for the IBM 3270 computer.
1827433 NOW \$ 15

IBM 3270 CONTROL PROGRAM/USERS GUIDE Software to control 3270 from mainframe.
183734 (User version & guide) NOW \$ 15

IBM 3270 EMULATION PROGRAM 2.0 Emulate IBM 3274 Control Unit, 2378/79 Display, & 3287 Printer. 59X9951 NOW \$ 49

IBM 3270 EMULATION PROGRAM 3.0 Up-grade to the above includes 3.5" & 5.25" disks.
59X9969 NOW \$ 99

IBM 3270 EMULATION PROGRAM 1.21 Gives IBM PCs 3278 or 3279 Display Station capability.
75X1085 NOW \$ 79

IBM 3270 WORKSTATION PROGRAM Gives IBM Personal Computer Workstations multi-session, windowing, and host display station capabilities and allows running of multiple DOS and host applications concurrently. Write programs that communicate across PC or between PC & host.
74X9921 (includes 3.5" & 5.25" disks) NOW \$ 79

IBM 3270 PC/AT GUIDE TO OPERATIONS
59X9962 or 6166570 NOW \$ 29

IBM 3270 CONTROL PROGRAM USERS GUIDE 59X9968 NOW \$ 29

IBM 3270 GUIDE TO OPERATIONS (HARDWARE) 59X9973 NOW \$ 39

IBM 3270 GUIDE TO OPERATION / USER MANUAL 6217355 NOW \$ 39

IBM 3278/79 EMULATION CONTROL PROG. Connect a PC with 3278/79 emulator to host.
6024134 NOW \$ 99

20

20

21

21

DOS - LANGUAGES & UTILITIES

FIXED DISK ORGANIZER - MENU

Organize programs into a series of convenient menu screens. Requires Hard Disk.

6024111 (Hard disk required) NOW \$ 19

IBM BASIC PRIMER 2.0 Learn to use the BASIC language through this helpful book.

6024129 NOW \$ 19

IBM BASIC MADE EASY Another good book for learning the BASIC language.

6024118 NOW \$ 19

IBM BASIC 3.0 Latest version of the BASIC reference book - good for clone owners, too!

6361132 NOW \$ 29

TURBO BASIC** Improved BASIC compiler by Borland for making .EXE files from BASIC code. 13FGBA910 or 13FGBA911

NOW \$ 59

TURBO C USERS GUIDE The handbook for owners of the Turbo C language compiler.

14FGCOM NOW \$ 39

MICROSOFT "C" OPTIMIZING COMPILER *** fast, professional C development environment.

MICROSOS-C NOW \$ 149

IBM MACRO ASSEMBLER 2 Write programs in Assembler & compile them into executable files.

6024193 (5.25" disk) WAS \$ 149 NOW \$ 39

IBM MACRO ASSEMBLER 2.0

Same as above, but in the 3.5" disk format.

6280077 NOW \$ 39

IBM PROFESSIONAL DEBUG UTILITY ***

A tool to debug programs written in Assembler.

6024143 (Includes NMI card for PC) NOW \$ 40

CP/M 86 *** Allows running of CP/M operating system based programs on the IBM PC.

6024025 NOW \$ 49

DOS

IBM DOS 2.10 The version for the PCjr.
60224213 \$40 new; \$25 used

IBM DOS 3.20 on 3.5" disk \$ 45

IBM DOS 5.0 on 3.5" disk \$ 65

IBM DOS TECHNICAL REFERENCE The reference for programmers - covers 2.10 through 3.10
6024213 \$ 39

MS-DOS 3.30 on 5.25" disks. \$ 69

MS-DOS 4.01 on 5.25" disks \$ 49

MS-DOS 5.0 on 5.25" disks \$ 59

COMPAQ DOS 2.11 5.25" disks \$ 39

COMPAQ DOS 3.1 5.25" disks \$ 49

NETWORKING

IBM PERSONAL COMMUNICATION MANAGER The IBM program for modem communications.
6023100 NOW \$ 5

LOCAL AREA NETWORK PROGRAM 1.10 *** Use with IBM network cards to set up networks.
280063 NOW \$ 45

PC NETWORK PROGRAM 1.0*** Share devices, send & receive messages within a network.
6024195 NOW \$ 79

IBM PC LOCAL AREA NETWORK 1.20 *** Upgrade of the above with PS/2 support.
75X1081 NOW \$ 109

IBM PC LOCAL AREA NETWORK 1.30 *** Upgrade of the above in 3.5" disk format.
84X0076 NOW \$ 179

IBM PC NETWORK + EDITION 1.0 *** Share Personal Decision Series resources in a network.
6476077 (3.5" disk format) NOW \$ 99

IBM CLUSTER SOFTWARE * Network software for IBM Cluster Card networks.
6024107 WAS \$ 349 NOW \$ 60

IBM NETWORK + EDITION *** Share Personal Decision Series resources in a network.
6476063 NOW \$129

EDUCATIONAL

LEARN DOS Guides the beginner through many of the elementary DOS commands that are confusing when getting started. Nor for use on the IBM PCjr \$ 19

COMPUTERS & COMMUNICATIONS Teaches how to use a computer in communications.
6024069 (Needs Private Tutor) NOW \$ 15

KAREL THE ROBOT Gently introduces the user to the PASCAL programming language.
6024066 WAS \$ 150 NOW \$ 49

KAREL THE ROBOT TEXTBOOK Guides the user from beginning through advanced lessons.
1502200 WAS \$ 8 NOW \$ 4

MONSTER MATH Elementary math skill builder erases part of a monster if answers are correct.
6024072 (Need BASIC cart. for PCjr) NOW \$ 19

BUMBLE GAMES Six challenging games to help children ages 4 to 10 build graphing skills.
6024094 (Need BASIC cart. for PCjr) NOW \$ 23

JUGGLE'S BUTTERFLY Three playful games to teach children ages 3 to 6 reading & math skills.
6024095 (Need BASIC cart. for PCjr) NOW \$ 19

BUMBLE PLOT Five challenging games to help children ages 8 to 13 develop geometry skills.
6024096 (Need BASIC cart. for PCjr) NOW \$ 23

GERTRUDE'S SECRETS Teaches children in grades K through 4 grouping & math skills.
6024097 WAS \$ 49 NOW \$ 23

ROCKY'S BOOTS Develops advanced thinking & logic skills for ages 9 to adult.
6024099 WAS \$ 50 NOW \$ 23

TEACHER'S QUIZ DESIGNER Create, edit, and administer tests; track scores and averages.
6024075 (Need BASIC cart. for PCjr) NOW \$ 35

PRIVATE TUTOR 2.00 Complete learning system for writing and presenting courses.
6024113 WAS \$ 55 NOW \$ 35

WRITING PRIVATE TUTOR COURSES A handbook for teachers for creating courses.
6024078 WAS \$ 12 NOW \$ 6

PUNCTUATION SKILLS A program to develop punctuation skills.
6024063 (Need Private Tutor) WAS \$55 NOW \$29

LANGUAGE SKILLS Covers rules for nouns, verbs, pronouns, adverbs, adjectives, etc.
6024084 (Need Private Tutor) WAS \$55 NOW \$29

CAPITALIZATION SKILLS Covers rules for names, initials, salutations, etc.
6024085 (Need Private Tutor) WAS \$55 NOW \$29

SPELLING SKILLS Covers rules for irregular plurals, silent "e", suffixes, "ie" and "ei", etc.
6024086 (Need Private Tutor) WAS \$55 NOW \$29

BASIC MADE EASY FOR PCjr Handbook especially for BASIC on the PCjr
6024116 WAS \$ 12 NOW \$ 8

TYPING TUTOR Instructional program to teach typing and build typing speed quickly.
6024013 WAS \$ 29 NOW \$ 12

LOGO 1.0 Flexible interactive language for young programmers ages 8 to 12.
6024067 WAS \$ 175 NOW \$ 69

LOGO:PROGRAMMING w/ TURTLE GRAPHICS A textbook for use with the LOGO software.
1502229 WAS \$ 12 NOW \$ 12

TURTLE POWER A version of LOGO for introducing children K - 4 to programming.
6024109 WAS \$ 55 NOW \$ 29

TURTLE POWER ACTIVITY BOOK Textbook for above with activities in math, reading, etc.
6024079 WAS \$ 11 NOW \$ 6

22

22

23

23

CD - ROM DRIVES



\$ 239

Internal

**MITSUMI CD - ROM
 COMPLETE KIT
 HALF HIGHT FORM FACTOR
 "SLIDE TOP LOADING"
 INTERFACE TO PC/AT 8 BIT BUS
 MSCDEX SUPPORTED
 AUDIO PLAYBACK FUNCTION
 DUST PROOF MECHANISM**

\$ 319

EXTERNAL

**MITSUMI CD - ROM
 COMPLETE ACCESSORY
 STAND ALONE ENCLOSURE
 INTERFACE ADAPTER
 CONNECTING CABLE
 FRONT LOADING MECHANISM
 INTERFACE TO PC/AT 8 BIT BUS
 MSCDEX SUPPORTED
 MULTI MEDIA SUPPORTED
 AUDIO PLAYBACK FUNCTION
 DUST PROOF MECHANISM**

CD - ROM SOFTWARE

\$ 199 Value \$ 399

When Purchased With CD - ROM

**ILLUSTRATED ENCYCLOPEDIA (Groiler 1991)
 REFERENCE LIBRARY (Software Toolworks)
 WORLD & US ATLAS (Software Toolworks)
 GAME PACK II (Software Toolworks).
 NATIONAL GEOGRAPHIC ANIMALS**

MISCELLANEOUS

TURTLE POWER THINKERS GUIDE Textbook
 for understanding children using Turtle Power.
 6024167 WAS \$ 11 NOW \$ 6

HYDROLOGIC CYCLE Color graphics show the
 movement of water from earth to sky and back.
 6024121(High school age)WAS \$5 NOW \$ 29

GROUND WATER Learn about natural ground-
 water cycles, and human impact on them.
 6024121(High school age)WAS \$55 NOW \$ 29

SURFACE WATER Learn about water flow
 erosion and other surface water topics.
 6024123(High school age)WAS \$55 NOW \$ 29

MOISTURE IN THE ATMOSPHERE Learn about
 atmospheric moisture & effects on environment.
 6024124(High school age)WAS \$55 NOW \$ 29

ELECTRIC POET Allows non-programmers to
 create color graphic & music presentations.
 6024172 WAS \$ 55 NOW \$ 39

COMMA CAT Use the poems of Dr. Edmond
 Skellings to teach punctuation. Grades 3 - 6.
 6024293(Electric Poet req)WAS \$ 49 NOW \$ 9

DICTIONARY DOG Helps build vocabulary by
 showing how to use a dictionary. Grades 3 - 6.
 6024067(Electric Poet req)WAS \$ 49 NOW \$ 9

AMERICAN EDUCATION COMPUTER SOFTWARE

SPELLING Teaches 4,233 most commonly
 used English words by "test-teach-test" method.
 Order by grade. Available for grades 2 - 6.

READING COMPREHENSION SKILLS
 Develops ability in cause & effect, similarity
 & difference, etc. Order by level.
 Level 3 for grades 7 - 8.

LEARN ABOUT WORDS IN READING
 Teaches word structure: prefix, suffix,
 synonyms, etc. Grades 2 - 4.

Cartridge BASIC required for above titles
 if used on PCjr. All titles \$ 12 each.

Q&A PLUS DIAGNOSTIC ver 3 *** Test and
 diagnostic software for the IBM PC, PC/XT &
 PC/AT and compatible Computers \$ 19

IRWIN EZ TAPE Tape backup driver software
 for 10 & 20 Meg IRWIN internal & external tape
 backup units. \$ 19

QMS LASER PRINTER SETUP SOFTWARE
 For the KISS & Big KISS laser Printers.
 Includes setup & Print Menu. \$ 19

**IBM PERSONAL PAGEPRINTER ADAPTER
 PROGRAM - version 1.3.1 *****
 59X6968 \$ 179

**IBM HARDWARE MAINTENANCE & SERVICE
 for PAGEPRINTER 3612**
 1686337 \$ 39

**IBM PC CONVERTIBLE HARDWARE MAINTEN-
 ANCE & SERVICE** Trouble-shooting guide.
 6280641 \$ 59

**ASYNCHRONOUS COMMUNICATION
 SUPPORT**
 6024032 \$ 15

**IBM LOCAL AREA NETWORK CONNECTION
 SERVER PROGRAM INSTALLATION &
 CONFIGURATION GUIDE *****
 83X9132 \$ 49

**IBM HARDWARE MAINTENANCE & SERVICE
 FOR THE IBM PC COMPUTER**
 6025072 \$ 39

ATTENTION PCjr OWNERS
SOFTWARE COMPATIBILITY LIST \$ 10

Probably one of the most important pieces of
 software the PCjr owner can have! Lists almost
 200+ titles, and you can easily update the list.
 Comes on 2 diskettes; 384K or more needed for
 using database program, but includes viewing
 utility for computers having only 128K.

24

24

25

25

Public Domain and Shareware Software

Programs marked * require 256K on PCjr

UTILITIES

001 UTILITY SAMPLER

A diskette with over 25 useful utility programs.

002 DISK CATALOG PROGRAMS

Includes CatUtil3 (*) for keeping track of your disk library.

030 RAM DISK UTILITIES (*)

Assorted programs for setting up a disk drive in your extra memory.

036 COLOR DISPLAY UTILITIES

Set your own screen colors.

075 ULTRA-UTILITIES (2 DISKS)

Nice utilities let you modify disk sectors, and more - for the experienced user!

113 DIRECTORY UTILITIES

Assortment of programs for help with your disk directories.

144 PC-WINDOW & EZ-DOS

Pop-up notepad, alarm clock, etc. and enhanced DOS commands

147 ANSIDRAW

Good program for creating graphic screens using ASCII characters.

153 NEWKEYS

Redefine your keyboard the way you want it with macros (256K is recommended).

157 PC-DISK CATALOG PROGRAM (*)

Good program for keeping track of your disk library.

173 VINCENT BLY UTILITIES

Includes improved TYPE command and RE-VIEW screen scroller.

203 STILL RIVER SHELL (*)

File manager with a DOS shell included!

253 FILE COMMANDO (*)

Good file manager similar to the above.

261 MORE DIRECTORY UTILITIES

Includes the excellent Directory Tool Kit.

276 DS-BACKUP

A better backup for your hard disk than DOS has to offer!

293 SHORCUT

Great file manager with a display LOADED with information!

304 HELPI & DIRECTORY MASTER (*)

Excellent for handling your files and directories!

305 AUTOMENU

Really good menu system--works with floppy or hard disks!

306 EXPAN-DIR (*)

Can't remember what a file is (or does)?

This is for you!

310 DESK COMMANDO (*)

This does things that Sidekick never even dreamed of!

312 AUTOMAX/ DIRECTORY SCANNER (*)

Excellent hard disk menu system and directory utility.

315 JRCONFIG UTILITY (*)

Super utility for PCjr--one line in CONFIG.

SYS file sets up your extra memory, video mode, RAM disk, and lots more!

331 NARC ARChive UTILITY

Un-ARC files with this menu-driven utility!

333 SOFTWARE PATCHES FOR THE PCjr

Patches for TurboBasic, QuickBasic, Starflight, and more!

COMMUNICATIONS

262 RBBS-PC (2 DISKS) (*) --

(Hard disk required)

Set up your own computer bulletin board!

281 PROCOMM (2 DISKS) (*)

Excellent communications program includes a host mode!

285 QMODEM (2 DISKS) (*)

Another excellent communications program (no host mode).

296 MINIHOST (*)

(Hayes-compatible modem required)

A miniature bulletin board with some good features!

299 QMODEM-Jr

Special version made for Jr.--this one is really good!

301 PCjr-TALK

Special version made for Jr.'s memory and internal modem.

307 TELIX (*)

This is one of the best programs yet!

313 GT POWER-COMM (4 DISKS) (*)

Good communications with powerful host mode. Hard disk required for use as a BBS.

329 ONE-TO-ONE

Nice, simple communications -- even has host mode!

322 PC RAILROAD

Run your own railroad empire!

323 BOARD GAMES

Monopoly (*) game. Chinese Checkers game has good graphics!

324 BIBLE GAMES (*)

Learn about Creation & the 10 Commandments-graphics & music

325 MORE ASSORTED GAMES

Mille Bournes, Mz. Pacman, Round 42 (*), and more!

326 CARD GAMES (*)

Poker, Bridge, and Solitaire are all here!

327 PIRATES (BASIC Cartridge Required)

Simple Adventure game with over 30 graphic screens!

328 ADVENTURE & ROGUE (*)

Two text games for you adventure fans!

330 X-WORD (384K Required!)

Great crossword puzzle generator for Epson & IBM Printers.

332 TRIVIA-WILLY THE WORM-REVERSI

Try your hand at Trivia questions, Willy the Worm, & Reversi.

OTHER PROGRAMS

005 PRINT SPOOLERS

Assortment of programs to make your printing jobs easier!

015 BRADFORD

Letter quality printing on Epson, Gemini, or IBM Graphics printers!

179 COMPUTER TUTOR

Good basic course in understanding computers and DOS.

180 FASTYPE

Excellent typing tutor program.

192 FAMILY HISTORY (BASIC Required)

Program for organizing your family tree.

193 FLOWCHART

Design and print your own flowcharts!

206 WORLD MAP (*) & WORLD TIME

Display world maps, or check the time in Paris!

278 PC PERSONAL GRAPHICS (*)

Not exactly Printshop, but still an excellent ShareWare program!

300 BEST PRINTER UTILITIES

A collection of some of the best printer utilities around!

316 POT-POURRI

Assorted programs from harmless pranks to assorted graphic demos.

334 PMS LABEL (*)

(Requires graphics printer)

Allows you to print address labels with graphics from PrintMaster or PrintShop.

336 PROPRINTER UTILITIES

Assorted utilities for IBM Proprinters.

338 PRINT PARTNER (*)

Excellent program for printing signs, banners & calendars. Includes Printmaster graphics. Requires IBM graphics printer.

ALL DISKETTES ARE \$5.00 EACH

Please note that some titles have 2 or more diskettes - you pay \$5.00 for EACH disk!

Postage and handling on Shareware orders is \$1.00 for the first disk, \$.50 for each additional disk.

WARRANTY INFORMATION

ABSOLUTELY NO REFUNDS ON SHAREWARE/PUBLIC DOMAIN SOFTWARE!

Defective diskettes will be replaced with the same title - no substitutions.

We make no warranty or representation of the fitness of this software for any purpose whatsoever, or of the skill of the user to operate or utilize same.

All questions regarding operation of the software should be directed to the author whose identity and location appears in the documentation file on the disk, or within the program.

PLEASE do not call us for technical support - contact the author/publisher.

Send all orders to: Computer Reset
P.O. Box 461782
Garland, TX 75046

Or call: (214) 276-8072*

26

26

27

177

335 JR-TELE

The best Communications program for the IBM PCjr Internal modem (also supports Hayes compatible modems).

BUSINESS - SPREADSHEET, DATA BASE, WORD PROCESSING, ETC.

019 PC-WRITE (*)

Good word processing program with many nice features.

023 TEXT EDITORS

Assorted text editors such as FRED, EDED, AWP, etc.

024 TURBO-SCRIPT

Nice little editor written for the PCjr

025 QUICK-EDIT

A good text editor that is FAST!

076 3-BY-5 DATABASE (*)

If you're using index cards, replace them with this!

111 FREE-CALC (*)

Similar to Multiplan, but a lot cheaper!

112 PC-CALC (256K Recommended)

Good spreadsheet program from the author of PC-File.

231 PC-FILE III (256K recommended)

A quality database system by ButtonWare--excellent!

232 FILE EXPRESS (2 DISKS) (*)

Pretty good database does sorts, searches, and reports.

273 BUSINESS LETTERS

Don't know how to say it? Here's 100 letters to help! Letters are stored as ASCII files so most word processors can be used to read and edit the letters.

291 EZ-FORMS (*)

Design and print your own blank or completed forms!

303 AS-EASY-AS (*)

Spreadsheet very similar to Lotus--includes graphing ability!

308 NAME-PAL

This one does it all--labels, lists, booklets, and rolodex cards!

311 GALAXY (*)

Excellent word processor with pull-down menus to help you!

314 CASH-TRAC 5.12 (*)

Helps manage your personal finances.

FOR D-BASE II & III USER'S ONLY!

052 ENCODE PSEUDO-COMPILER

Compile your DB-II command files to run 30% faster!

054 ASSORTED DB-II PROGRAMS

Mailing list, label printer, etc. for DB-II.

060 MORE ASSORTED DB-II PROGRAMS

Contains reminder, phone book, expenses, etc. for DB-II.

072 DB-MENU & TIPS

Create your own menus. Also has many tips in ASCII files.

284 DB-III SCREEN EDITOR & PROGRAM GENERATOR

Design a screen, and this will write the program for you!

GAMES, GAMES, AND MORE GAMES!

217 GAMES

Assorted .EXE games like Sopwith (*), Invaders, & Chess.

219 BASIC GAMES (BASIC Required)

Assorted games like Bowling, Dominoes, Yahtzee, etc. written in BASIC language.

223 BUSHIDO (*)

(Need full-size PC keyboard on PCjr!) Fast-paced martial arts game with excellent graphics!

225 D N D (*)

If you like Dungeons and Dragons, this one's for you!

309 SAILING /WORDPLAY/PC-BOWL (*)

Sail the Bermuda Triangle, play Wheel of Fortune, and go bowling on your PC!

317 ASSORTED GAMES

Word-Search Puzzle-Maker, Fire-Fighter & Cliffy games.

318 DUNGEONS OF MORIA (2 DISKS)

(640K Required!)

Another one for you D and D fans!

319 BEGIN (*)

Another starship simulator (NOT an arcade-style game).

320 AMERICAN CUP (*)

Nice sailing race simulator!

321 PC-HACK (384K Required!)

Text adventure game--large vocabulary!

Text adventure game--large vocabulary!

NOTEBOOK COMPUTER



TANDY MODEL 100

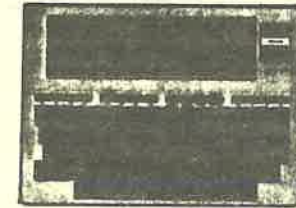

Unique notebook computer with 5 built-in applications: BASIC, Text Editor, Address / Phone Directory, Appointment Calendar, and Modem Communications. Ideal for the person on the go, Executives, Salesmen, Students, Newspaper Reporters, - have information on hand anytime.

Includes an internal 300-baud modem, parallel printer interface with cable, serial port, cassette port, bar code reader interface, and telephone cable. A Bubble Memory adds 128K of storage capacity in 5 storage sections aside from the 32K RAM inside the computer. In storing text the MODEL 100 will store 12 single spaced pages of typed text in its internal memory. The Bubble Memory stores 5 times the memory of the Model 100 and is attached to the underside of the computer, roughly doubling its thickness. A special AC adapter that operates both the Bubble Memory and the computer, batteries can be used for mobile operation..

SPECIFICATIONS: 8-bit 80C85 CMOS microprocessor - 2.4 MHz clock speed - Full-size 56-key keyboard with embedded numeric keypad, 8 programmable function keys, 4 command keys, and 4 cursor control keys - 8 line by 40 character LCD screen - Built-in direct-connect 300 baud modem with originate and answer capability - Parallel printer interface - RS-232C serial interface programmable up to 19,200 baud - Cassette tape interface - Standard bar-code reader interface - Weighs 3.9 lbs. (without Bubble Memory) - (Bubble Memory Weight 1.6 lbs.) - Measures 2 x 11-7/8 x 8-1/2 inches (without Bubble Memory).
Battery power - uses AA alkaline cells - life in excess of TEN (10) hours.

SOFTWARE: This unit is not a software orphan, besides the five built in useful software tools many shareware programs are available. LAPDOS file transfer program is available to exchange text and data files between from this computer and your IBM compatible PC or Apple Macintosh.

All units are USED but in good working condition. 30 Day Warranty. When ordering by mail, include \$10 for shipping, handling, and insurance. Phone orders are C.O.D. only (add \$5 C.O.D. charge to shipping cost).

Limited Stock Order Today!



CALL (214) 278-8072
P.O. Box 481782

COMPUTER
RESET

FAX & BBS (214) 272-7920
Dallas, Texas 75048 - 1782



PACKAGE SPECIAL
TANDY DMP-105 Printer (Used) \$ 89
with purchase of Tandy 100 Only \$ 69

28

28

29

29

**COMPUTER
RESET**

P.O. Box 461782
GARLAND, TEXAS 75046-1782
(214) 276 - 8072

Name _____ Phone (____) _____

Street Address _____ FAX (____) _____

City _____ State _____ ZIP _____ Date _____

Country _____ or Province _____ or Postal Code _____ First Order Yes No

| Description of Item | Quantity | Price Each | Total Price |
|---------------------|----------|------------|-------------|
| 1 | | | |
| 2 | | | |
| 3 | | | |
| 4 | | | |
| 5 | | | |
| 6 | | | |
| 7 | | | |
| 8 | | | |
| 9 | | | |
| 10 | | | |

All Items subject to prior sale or price change without notice
Check Box If you will NOT allow substitution

SALES TAXES _____
* Sales Tax applies to Sales to be delivered in Texas at Tax Rate Varies 6.5% to 8.25% with your address. If Claiming Exemption from Texas Sales and Use Tax we Must have on file a copy of your TEXAS Sales and Use tax resale certificate or signed resale statement before goods can be shipped.

Item Total _____
Optional Insurance 2% _____
Shipping & Handling \$ 5 Min _____
Sub TOTAL _____
*Sales Tax on Sub Total _____
COD \$ 4 UPS \$ 5 Fed Exp _____
PAY TOTAL _____

| | |
|--|--|
| | |
| | |
| | |
| | |
| | |
| | |
| | |
| | |

FUTURE CATALOGS _____
Add \$ 1 to the total for your order in line 10 and request FUTURE CATALOGS to assure that you will be kept on our mailing to receive all catalogs and supplements for the next year.

PAID BY Money Order
Cashiers Check
Personal or Business Check
Check Number _____

TERMS AND CONDITIONS appear on back of order form
Product Warranty Information is in the catalog. Call if you wish to receive a copy of our warranty information.

PURCHASE ORDERS: We accept purchase orders from Public Schools, Government Agencies and selected corporations with credit approval. Please attach your signed and approved purchase order to this form and mail or FAX it to us for prompt processing.

FREE send a catalog to a FRIEND Write their name and address below _____
Name _____
Street Address _____
City _____ State _____ ZIP _____
Country _____ or Province _____ or Postal Code _____

Open Bulletin Board System - and FAX (214) 272 - 7920
See our list of Things to Buy, Sell and Trade - 300 to 2400 Baud, 8 Bits, 1 Stop Bit, No parity or PASSWORD

COMPUTER RESET Terms and Conditions of Sale

1. AGREEMENT The purchase and sale of the products covered by this invoice or order form are governed by the terms and conditions set forth herein. Computer Reset rejects all additional and/or different terms contained in Buyer's order and/or related documents from Buyer. Computer Reset's acceptance of Buyer's order is expressly made conditional on Buyer's assent to all the terms and conditions contained herein. None of Buyer's terms and conditions are binding on Computer Reset unless an authorized Computer Reset representative accepts them in a separate written agreement. No oral statements or representations shall be binding on Computer Reset regarding Buyer's order unless set forth in this invoice or order form. Any item or service furnished by Computer Reset in furtherance of Buyer's order, although not specifically identified in it, shall nevertheless be covered by the provisions of this invoice or order, unless specifically covered by some other written agreement signed by an officer of Computer Reset.

2. DELIVERY Computer Reset will make a reasonable effort to fill accepted orders within Computer Reset's normal lead times but Computer Reset shall not be responsible for delays or failure to deliver due to any cause. Computer Reset reserves the right to make allocations among its customers as it may in its sole discretion determine. After an order has been accepted by Computer Reset it shall not be cancelled by Buyer, nor shall the delivery of the products covered by the order be rescheduled by Buyer, unless written notice of cancellation or rescheduling from Buyer is received by Computer Reset at least three (3) business days prior to the original scheduled delivery date. All products will be shipped F.O.B. Dallas, Texas, or such other location as computer reset may choose. Computer Reset may package and ship products in any commercially reasonable manner. Risk of loss or damage shall pass to Buyer upon shipment.

3. PRICES Prices are F.O.B. Dallas, Texas unless Computer Reset otherwise designates. Prices do not include any federal, local, state or other sales or use taxes, duties or similar charges. All such taxes, duties and similar charges may be added to the invoice or order form and if so added shall be paid by Buyer. Texas residents who are a Buyer are subject to Texas sales and use taxes which will be added to the invoice or order. In placing an order with Computer Reset Buyer agrees to pay all state, county, and city, sales, use and other taxes applicable within their respective state of residency and acknowledges that nonpayment of sales and use taxes for any commercial transaction may result in civil and criminal penalties to Buyer.

4. PAYMENT All products will be shipped on a prepaid or C.O.D. basis unless Computer Reset has agreed in writing to credit terms prior to shipment. All C.O.D. shipments shall be paid by cash, bank cashier's check, postal money order. A Buyer's check may be used for payment only with prior written approval of Computer Reset. Credit terms are net (10) days from the date of shipment unless otherwise agreed in writing by computer Reset, subject to the credit limit established by Computer Reset from time to time. On any order where credit is not extended, shipment shall be on such basis as Computer Reset and Buyer shall agree in writing with all costs of collection paid by Buyer. Computer Reset reserves the right at all times, either generally or with respect to any specific order, to change or limit the amount or duration of Buyer's credit. Buyer authorizes partial shipments and payment in due for each shipment separately. Buyer shall pay Computer Reset interest on all invoiced amounts not paid when due at the rate of eighteen percent (18%) per annum or the highest lawful rate, whichever is less, provided, however, that the parties intend to comply strictly with applicable usury laws, so that any circumstance occurring in connection with the transaction subject hereof which would otherwise appear to constitute a violation of such usury laws shall be deemed automatically, ab initio, to be reformed to prevent the contracting or charging of usurious interest, or to apply to the payment of what otherwise would be unlawful or usurious interest to a lawful debt or to be refunded to the Buyer, as the case may be. Buyer hereby grants to computer reset a purchase money security interest in all products purchased by Buyer and the proceeds thereof until payment in full has been made. Buyer shall execute all documents deemed necessary or desirable by Computer Reset to protect or perfect such security interest. Computer Reset may file a copy of Buyer's order as a financing statement to perfect such security interest.

5. SERVICE PART EXCHANGE When an Exchange Service Part is shipped to Buyer in advance of Computer Reset's receipt of the defective part an Exchange Part Core Deposit Charge of fifty percent (50%) of the service part exchange price is added to the sale price. A refund of the Exchange Part Core Deposit Charge will be made after receipt of the defective service part by Computer Reset. Defective service parts that have been modified by Buyer or to which Buyer has attempted to repair are not eligible for refund of the Exchange Part Core Charge.

6. DAMAGE OR SHORTAGE CLAIM Buyer has the responsibility to inspect all shipments to Buyer and note any physical damage on the delivery receipt before signing. In case of concealed damage or loss, Buyer must retain all packing material for inspection by the freight carrier. Any damage, loss, shortage, or other discrepancy with Buyer's order must be reported within ten (10) days of receipt. Computer Reset is not responsible for any damaged shipments that have not been inspected by the freight carrier.

7. RETURNS FOR EXCHANGE All merchandise returned for exchange or credit must be in the original packing carton with all booklets, documents, diskettes, instructions and the like and accompanied by the original sales receipt or invoice and shipped at Buyer's cost to Computer Reset at its facility. No cash refunds will be made, exchange of products or credit only. Labor or service work charges and shipping charges are not creditable as an exchange. Opened software is NOT returnable unless it is defective and returned for an exact replacement. Shareware software is NOT returnable. All returned or refused merchandise is subject to a 20% restocking charge. Requests for return or exchange of any merchandise will not be honored after 30 days from the date of delivery.

8. COMPATIBILITY Computer Reset does not guarantee compatibility of computer products either software or hardware due to the wide range of products, technical sensitivity of computer products and technical expertise necessary to utilize same.

9. PROPRIETARY RIGHTS Computer Reset may provide data to Buyer relating to its products. Portions of such data are proprietary to Computer Reset and will be so marked. Buyer shall abide by the provisions of such markings. Computer Reset retains and reserves for itself, exclusively, all proprietary rights in and to all designs, specifications, engineering specifications, engineering details and other data pertaining to Computer Reset products.

10. LIMITED WARRANTY, DISCLAIMER OF WARRANTIES, AND LIMITATION OF LIABILITIES

a. Equipment warranty - Computer Reset warrants durable equipment manufactured by Computer Reset that makes no warrant as to expendable, perishable or consumable items such as, without limitation, ribbons, diskettes and batteries) against defects in material and workmanship under normal use for and service for a period of time as specified in Computer Reset's current Warranty Schedule from the date of the purchase by the Buyer. The sole and exclusive remedies of Buyer under the foregoing equipment warranty is that Computer Reset will at its option, upon written notice by the Buyer of a warranty claim and return of the covered equipment by Buyer to Computer Reset at Buyer's cost, either (i) repair or replace any item of equipment which fails during the warranty period because of defect of workmanship or material; or (ii) refund the purchase price of the equipment. Repaired or replaced equipment is warranted as set forth in this Section 6(a) for the remainder of the original warranty period applicable to the defective equipment. As a condition precedent to enforcement of the equipment warranty, the Buyer must (i) obtain from Computer Reset a Return Material Authorization Number (RMANo.) and shipping instructions prior to expiration of the warranty period; (ii) ship the equipment, transportation prepaid, to Computer Reset's facility as designated by Computer Reset; and (iii) provide proof of the date of purchase reasonably satisfactory to Computer Reset and a written description of the claimed defect. Computer Reset will pay the cost of returning the repaired or replacement equipment to a location designated by Buyer within the contiguous forty-eight (48) states and the District of Columbia. If Computer Reset determines that equipment subject of a warranty claim is not defective under the terms of the warranty, the Buyer must pay Computer Reset all costs of handling, transportation and repair with regard thereto at Computer Reset's then current charges. Computer Reset makes NO Warranty of fitness of use or merchantability for goods sold in an AS IS condition.

b. **DISCLAIMER OF WARRANTY - EXCEPT FOR EXPRESS WARRANTY STATED IN SECTION 6(a) ABOVE AND AS PROVIDED BY THE OTHER MANUFACTURER OF THE EQUIPMENT, EXPRESS AND IMPLIED, INCLUDING WITHOUT LIMITATION THE IMPLIED WARRANTIES OF MERCHANTABILITY, FITNESS FOR A PARTICULAR PURPOSE, AND FREEDOM FROM INFRINGEMENT, WITH REGARD TO THE GOODS OR SERVICES SUBJECT OF THIS INVOICE OR ORDER. No representation or other affirmation of fact or opinion, including but not limited to statements regarding suitability for use or performance of products, whether made by Computer Reset employees, representatives or otherwise, shall be warranty by Computer Reset for any purpose or give rise to any liability of Computer Reset whatsoever, unless contained in Section 10(a) above.**

c. **LIMITATION OF LIABILITIES THE WARRANTY SET FORTH IN SECTION 6(a) ABOVE EXTENDS ONLY THE FIRST BUYER OF THE PRODUCT FROM COMPUTER RESET AND IS CONTINGENT UPON PROPER USE OF THE PRODUCT. THE WARRANTY WILL NOT APPLY TO ANY FAILURE CAUSED BY:**

- (i) accident; unusual physical, electrical or electromagnetic stress; neglect; misuse; fluctuation in electrical power beyond manufacturer's specifications; air conditioning, heating or humidity control; modification of the product by Buyer; normal wear and tear; user's failure to operate or maintain the product according to the manufacturer's instructions;
- (ii) use of the product with any materials, equipment or goods not furnished by Computer Reset; or
- (iii) installation, alteration or repair of the product by anyone other than Computer Reset.

This warranty will not apply to products on which the original identification marks have been removed or altered.

IN NO EVENT SHALL COMPUTER RESET BE LIABLE TO THE BUYER OR ANY OTHER PERSON FOR ANY INDIRECT, INCIDENTAL, SPECIAL, OR CONSEQUENTIAL DAMAGES INCLUDING THE LOSS OF ANY DATA, OR DAMAGES RESULTING FROM ANY LOSS, WHETHER ARISING OUT OF TORT, NEGLIGENCE, BREACH OF WARRANTY, BREACH OF CONTRACT, OR OTHERWISE.

11. DESIGN CHANGES - Computer Reset reserves the right to make changes in the design or composition of its products without incurring any obligation to incorporate such changes in any product previously provided or sold. Computer Reset may make such changes available to customers for field installation at Buyer's option and cost. Computer Reset is not responsible for design changes in any products manufactured by any Other Manufacturer, and all obligation and responsibility for such changes is solely with such Other Manufacturer.

12. GENERAL - If Computer Reset employs legal counsel to enforce any of the terms and conditions hereof, Buyer shall reimburse Computer Reset for all costs and attorney's fees incurred in connection herewith. The failure of either party to enforce any provision hereof in one or more instances shall not be construed to be a waiver of such provision in other instance or of the right to enforce each and every provision. All rights and remedies of Buyer hereunder are exclusive. If any provision of this invoice is held invalid, it shall not affect the validity of any other provision. This instrument and the transaction(s) subject hereof shall be governed in all respects by the laws of the State of Texas and venue for any dispute hereunder or in connection herewith shall lie and remain exclusively in Dallas County, Texas. All rules and regulations of the International Trade Commission are completely specifically excluded from all transactions arising from this Agreement.

Computer Reset PO Box 461782, Garland, TX 75046-1782
Tel: (214) 276-8072 Fax: (214) 272-7920